

Shop Supplies

Columbus Fleet Industrial Supply

Canton Fleet Industrial Supply

Canton First Aid & Safety



Brushes

Cleaning Brushes



MICROFIBER WASH MITT

Part #	ITEM	QT
368-850	Wash Mitt	Ea



FENDER AND BODY BRUSH

Part #	ITEM	QT
369-010	Fender and Body Brush	Ea



FENDER AND BODY BRUSH

Part #	ITEM	QT
369-015	Wheel and Fender	Ea



FENDER AND BODY BRUSH

Part #	ITEM	QT
369-020	Fender and Body Brush Long Handle	Ea



FENDER AND BODY BRUSH

Part #	ITEM	QT
369-027	20" Soft Grip Brush	Ea



FLOW-THRU WASH BRUSH

Part #	ITEM	QT
369-037	10" Soft Green	Ea



SOFT WASH BRUSH

Part #	ITEM	QT
369-045	9" Soft White	Ea



SYNTHETIC WASH BRUSH

Part #	ITEM	QT
369-050	8" Soft	Ea
369-055	10" Soft	Ea

Brushes

Cleaning Brushes



MEDIUM WASH BRUSH

Part #	ITEM	QT
369-065	10" Natural Medium Wash	Ea



SOFT FLOW-THRU BRUSH

Part #	ITEM	QT
369-070	10" Soft Flow-Thru	Ea



STIFF WASH BRUSH

Part #	ITEM	QT
369-097	10" Tampico Stiff Wash	Ea



5 LEVEL WASH BRUSH

Part #	ITEM	QT
369-120	5 Level Salt and Pepper Wash	Ea

Brushes

Cleaning Brushes

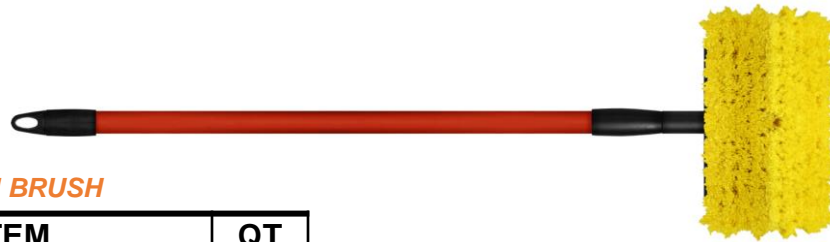

BI-LEVEL WASH BRUSH

Part #	ITEM	QT
369-124	8" Bi-Level Wash Handle reach 31" – 55"	Ea



SYNTHETIC FLOW-THRU WASH BRUSH

Part #	ITEM	QT
369-075	Carrand Flo-Thru Wash Brush and Handle	Ea

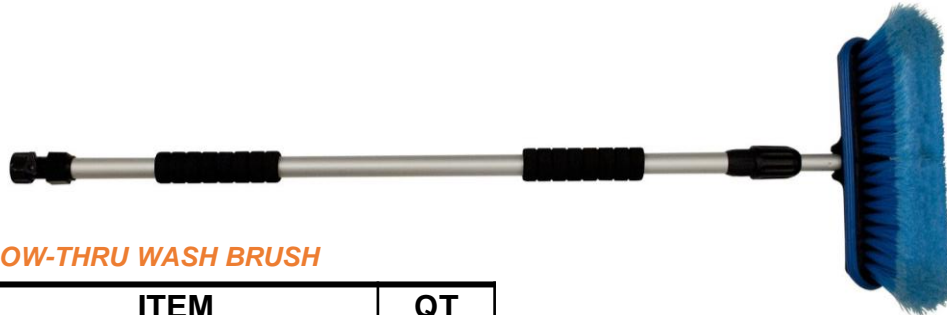

FLOW-THRU WASH BRUSH

Part #	ITEM	QT
369-135	60" Flow-Thru Wash Brush 10" Head	Ea

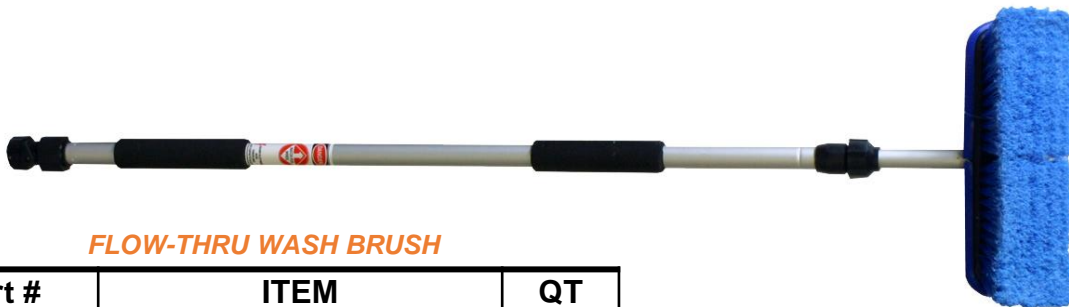

FLOW-THRU WASH BRUSH

Part #	ITEM	QT
369-140	62" Flow-Thru Wash Brush 10" Head	Ea

Brooms

Floor Brush Head, 2 1/2" Head Black Tampico Fiber

- Heavy-duty black tampico brush.
- Lacquered hardwood block.
- Two threaded handle holes.
- 3" Trim.
- Recommended for medium sweeping.
- Metal tip handle is not included



Part #	ITEM	LENGTH	QT
369-201	Medium Broom	18"	Ea
369-202	Medium Broom	24"	Ea
369-206	Medium Broom	36"	Ea

Floor Brush Head, 3 1/4" Head Natural Palmyra Fiber

- Stiff Palmyra fiber brush.
- Lacquered hardwood block.
- 4" Trim
- Excellent on wood or rough concrete floors either wet or dry.
- Metal tip handle is not included.



Part #	ITEM	LENGTH	QT
369-230	Coarse Broom	18"	Ea
369-235	Coarse Broom	24"	Ea
369-240	Coarse Broom	36"	Ea

Floor Brush Head, Flagged Polypropylene Bristles

- Structural resin block; will not crack, warp, or bend
- Dual threaded hole block will accept any standard threaded handle
- Dual bristles for maximum cleaning power
- Super stiff interior bristles dislodge stuck on dirt and debris
- Stiff, fine outer bristles pick up small particles
- Sweeps dirt, soil, mulch, wet grass, wood and Oil Dri®
- Use outdoor on wet or dry surfaces
- Ideal for garage floors, driveways, patios, sidewalks, asphalt, and barns
- Metal tip handle is not included.



Part #	ITEM	LENGTH	QT
369-260	All-purpose wet & dry	18"	Ea
369-262	All-purpose wet & dry	24"	Ea
369-264	All-purpose wet & dry	36"	Ea

Brooms

BROOM HANDLE

Part #	ITEM	LENGTH	QT
369-196	Fiberglass w/metal tip	60"	Ea
369-200	Wood Handle w/metal tip	60"	Ea



BROOM BRACE

Metal Broom Braces, Small, Fits 18" to 48" Floor Sweeps

- Metal brace reinforces floor sweep handle to prevent breakage.
- Rust-resistant plated parts quickly connect.
- Fits 24" to 48" floor sweeps.
- Hardware included.

Part #	ITEM	QT
369-194	Brace	Ea

Metal Handle Braces, Large, Fits 24" to 48" Floor Sweeps

- Metal brace reinforces floor sweep handle to prevent breakage
- Rust-resistant plated parts quickly connect
- Fits up to 48" handle
- Hardware included



BROOM BRACE

Part #	ITEM	QT
369-195	C - Brace	Ea

Squeegee

Floor Squeegee

Part #	ITEM	QT
369-309	30" Foam Straight	Ea



Windshield Squeegee

Part #	ITEM	QT
369-425	8" x 20" Long Handle	Ea



Deluxe Snow Brush Scraper

Part #	ITEM	QT
369-450	8" x 22" Long Handle	Ea



Shop Supplies

SPARPIE CHINA WHITE MARKER

FEATURES

- Label and draw on glossy objects with this white peel off china marker
- This versatile paper wrapped, pencil style instrument is a soft, crayon like medium
- Works well on glass and ceramic with porous and nonporous surfaces
- Color: white
- 12 piece per package



Part #	Item	Qt
379-650	white	Ea



M1 Fine Point

- • All purpose permanent ink with exceptionally fast dry time for marking on metals, glass, plastics, rubber, wood, wax cartons, corrugated textiles, and more.
- • UV and weather resistant.
- • Non-toxic (per ASTM D 4236) and xylene-free.
- • Resilient tip for consistent marking, excellent "cap off" time.
- • Aluminum Barrel. • Anti-roll cap with clip.

Part #	Item	Qt
379-422	White	Ea
379-455	Red	Ea
379-460	Black	Ea

Shop Supplies

M3 Medium Point All Purpose Ink Marker FEATURES

- Advanced valve technology allows controlled ink flow
- Reversible bullet/chisel nib adds marking options
- Marks on wood survey stakes, boxes, packaging tape, plastic bottles, metal drums, tags, etc
- Perfect for shipping rooms, warehouses, construction sites and maintenance cribs
- Great choice for any tool box



Part #	Item	Qt
379-465	Red	Ea
379-470	Black	Ea

130P Chisel Point All Purpose Paint Marker FEATURES

- A premium marker for industrial jobs, with 30% more industrial paint, a versatile, impact resistant tip and anti-roll cap
- Durable and hefty 5/8" barrel is designed specifically for professional use
- 30% more paint for large marking jobs
- Reversible bullet / chisel tip provides more marking options
- Anti-roll cap with clip is easy to remove and replace

TYPICAL USES • Marks well on rusty and oily metals, dry or damp wood, glass, plastics, rubber tape, cardboard, waxed cartons, ceramics, tiles, concrete, and more



J&B#	ITEM	Qt
379-516	Replacement Tip	Ea



Part #	Item	Qt
379-501	Red	Ea
379-502	White	Ea
379-503	Yellow	Ea
379-504	Green	Ea
379-505	Blue	Ea
379-507	Black	Ea
379-509	Brown	Ea
379-511	Silver	Ea
379-513	Orange	Ea



12 Pc Assortment

Part #	Qt
379-520	Ea

Shop Supplies

Premium Grade 8.5 mil Vinyl

**** Compare To 3M Super 88 ****

- *High Quality 8.5 mil black electrical tape.*
- *Resists: UV rays, acids, alkalis, abrasion, moisture, and corrosion.*
- *Suitable for cold and hot environments.*
- *Broad Temperature range: -18°C to 105°C*
- **Meets ASTM D-3005 and MIL-I-24391C specifications.**



Part #	Item	Size	Qt
380-026	850	3/4 X 66"	Ea

Premium Grade 7 mil Vinyl

**** Compare To 3M 33 Plus ****

- *Cold and heat resistant – suitable for all climates.*
- *Resists: UV rays, acids, alkalis, abrasion, moisture, and corrosion.*
- *Tape maintains tensile strength, adhesion and integrity over Broad Temperature range: -18°C to 105°C*
- *Best all-around vinyl for primary electrical insulation for wire and cable splices rated up to 600 volts.*
- **Meets ASTM D-3005 and HHI-595 specifications.**



Part #	Item	Size	Qt
380-024	750	3/4 X 66"	Ea

Super 33+ Premium Grade 7 mil Vinyl

America's #1 professional grade vinyl electrical tape, Scotch® Vinyl Electrical Tape is a premium grade, 7 mil thick, all-weather vinyl-insulating tape. It is designed to perform continuously between a temperature range of 0 to 220°F (-18 to 105°C).



Part #	Size	Qt
380-020	3/4 X 52"	Ea

Shop Supplies

3M Tartan Vinyl Electrical Tape

Good quality, economical general purpose insulating tape
The elastic backing ensures easy, moisture tight conformation to irregular surfaces

Combines the flexibility of a PVC backing with good electrical insulating properties to provide primary electrical insulation for splices
Abrasion, corrosion, and UV resistant, Makes a good protective jacketing UL Listed Flame retardant Offers good resistance to moisture, alkalis, acid, and varying weather conditions (including ultraviolet).



Part #	Item	Size	Qt
380-010	3M Tartan	3/4 X 60"	Ea

Color Vinyl Electrical Tape

A good quality, economical general purpose insulating tape
The elastic backing ensures easy, moisture tight conformation to irregular surfaces

Part #	Item	Size	Qt
380-016	Red	3/4 X 60"	Ea
380-017	Yellow		
380-018	Orange		
380-019	Green		



Self-Amalgamating Electrical Tape

- High quality, un-vulcanized EPR rubber with first-rate self-amalgamating properties carried on a thick poly liner.
- Primary insulation for electrical wires and cables splices of not more than 600V.
- High elongation conforms to irregular shapes.
- Suitable for industrial pipe repair, automotive, marine, construction, and many other general applications.
- Dielectric strength 490 volts per mil.
- Flexible over a wide temperature range: Max operating temperature 176°F.
- Recommended to be overwrapped for mechanical protection and durability with friction or vinyl tapes.
- **UL 510 listed.**
- **Meets requirements of**
- **ASTM-D119 and HHI-553C.**
- Made in USA



Part #	Item	Size	Qt
380-030	Cold Shrink	1" X 30'	Ea

Shop Supplies

Rescue Tape Industrial Roll

SELF-FUSING Silicone Wrap - Sil/Fuse tape fuses together rapidly when applied under tension to provide a solid, continuous wrapping.

- HIGH PERFORMANCE SILICONE BASE - Resists continuous operating temperatures from -76° to +392°F, up to 500°F intermittently.
- SUPERIOR INSULATING AND SEALING - As effective as heat shrink tubing but requires no heat and can be applied anywhere.
- HIGH DIELECTRIC STRENGTH - 20 mil tape thickness
- provides up to 400 volts/mil dielectric.
- NO ADHESIVE BACKING - Sil/Fuse tape sticks only to itself and leaves no residue on connections.
- REMOVABLE - Removes cleanly when cut, allowing connections to be opened for inspection or repair.
- WILL NOT BECOME BRITTLE - Retains maximum flexibility and versatility under all conditions and
- temperatures. ENVIRONMENTAL & CHEMICAL SEAL – Completely waterproof and resists chemicals, salt water, sunlight,
- fuels, and solvents.

FEATURES:

- A unique self-fusing insulating water-tight wrap offering protection against moisture and corrosion
- Cures without adhesive or heat – designed to fuse to itself and will not unwind or loosen in the application
- Stays pliable during extremely cold applications
- No pre-cleaning necessary – easy to use
- Easy to remove if required – Seal-Tite™ Fusion Wrap will not stick to the wrapped surface
- Available in a clear version for easy identification of wrapped surfaces
- 1" x 54' roll
- Wide temperature range – remains flexible from – 80°F to +400°F (–62°C to +204°C)
- Dielectric strength 400V/mil (20 mil thickness)

Applications

- For use in applications with tight tolerances or where heat cannot be used
- Insulate electrical connections
- Repair SO and SJO cord
- Split bolts
- Wire taps
- Repair welding cable and battery cable

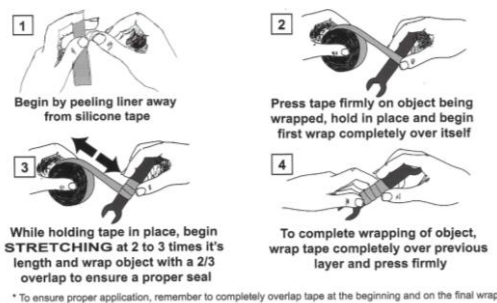

Part #	Item	Size	Qt
380-035	Black	1' X 10'	Ea

Shop Supplies

Liquid Electrical Tape forms a protective dielectric coating on electrical connections

- Completely seals connections - prevents corrosion
- Extremely high dielectric strength - almost twice the dielectric strength of conventional electrical tapes
- Can be applied to irregular shapes and hard-to-reach connections
- Absorbs vibration to prevent terminal screw loosening
- Will not unravel or peel off
- Fast drying - puts equipment back in service fast
- Adheres to all metal, plastic, vinyl, rubber and composite materials

Part #	Item	Size	Qt
380-070	Brush-On	8 oz	Ea



Dielectric Grease

- Corrosion preventive compound for electrical contacts, switches & junction boxes
- For periodic use with all electrical contact not using Fit 'N Forget connectors.
- NYK-77 Compound

Part #	Item	Qt
289-150	8 oz Pressurized	Ea
289-175	3 oz Tube	Ea



Part #	Item	Qt
289-145	90 ml	Ea
289-147	90 ml with Valve	Ea

Shop Supplies

Medium density PTFE tape

- provides service in a wide range of applications
- Prevents leaks on worn threads and seals imperfections for increased reliability
- Resists chemicals, acids, alkalis, caustics, corrosives, fuels, gases, refrigerants, solvents and other aggressive compounds
- Approved for oxygen service applications
- Meets Mil Spec. T-27730A
- Withstands pressures from hard vacuum up to 10,000 P.S.I.
- Temperature range -450° to +500°F.
- May be used on all types of metal and plastic pipe threaded connections



Medium-Density

Part #	Item	Qt
380-250	1/2" X 520"	Ea
380-254	3/4 X 260"	Ea
380-256	1" X 260"	Ea

High density PTFE tape

- provides superior sealing performance and increased reliability
- Prevents leaks on worn threads, and seals imperfections for maximum reliability
- Easier to handle & apply than regular PTFE tapes
- U.L. listed under CHM1677 Pipe Joint Tape 14710 and 12780
- Resists chemicals, acids, alkalis, caustics, corrosives, fuels, gases, refrigerants, solvents and other aggressive compounds
- High density tapes resists stringing and shredding
- Meets Mil Specs. T-27730A and AA-58092
- Withstands pressures up to 10,000 P.S.I.
- (rated 2,250 P.S.I. for hazardous, flammable gases).
- Temperature range -450° to +500°F.
- May be used on all types of metal and plastic pipe threaded connections



High-Density .0035 Thick

Part #	Item	Qt
380-260	1/2" X 520"	Ea
380-262	3/4 X 520"	Ea

EXTRA HEAVY DUTY - Extra high-density nickel PTFE tape

- resists stringing, shredding while providing superior sealing performance
- HIGH PERFORMANCE - 4.0 mil double-thick PTFE tape has nickel flakes blended with PTFE resins which offers excellent lubrication, prevents seizing and galling
- VERSATILE - Ideal on all types of metal and plastic threaded connections with worn threads and surface imperfections
- RESISTANT - Resists chemicals, acids, alkali's, caustics, corrosives, fuels, gases, refrigerants, solvents and other aggressive compounds.
- WIDE RANGE OF METALS - Use on stainless steel, carbon steels, alloys, and other exotic metals
- HIGH PRESSURE APPLICATIONS - Withstands pressures up to 10,000 P.S.I.
- MILITARY SPECS: T-27730A and CID A-A 58092
- TEMPERATURE RANGE: -450°F to +550°F



High-Density .0035 Poly Temp
(for stainless)

Part #	Item	Qt
380-275	1/2" X 260"	Ea

Shop Supplies

Medium Duty Duct tape: 7 mil (1.88" X 60 yd)

- Can be used for long term repairs, sealing, bundling and marking; has long shelf life and retains strength for up to 2 years on both outdoor and indoor applications.
- Reinforced rubber adhesive sticks well to metal, plastic, concrete and on smooth, contoured and textured surfaces.
- Thick surface allows extreme conditions and heavy exposure to harsh elements yet is still easy to tear and install, remove or reposition.
- Silver polyethylene surface layer is moisture, weather, abrasion, heat and UV resistant for long term application at harsh conditions and is compatible with marker pens for labeling.



Part #	Qt
380-314	Ea

Medium Duty Black Duct tape: 7 mil (1.88" X 60 yd)

- High tensile strength and tears cleanly across
- Industrial strength for bundling, sealing, and protecting

Industrial-grade duct tape for splicing, masking, patching, sealing and seaming.



Part #	Qt
380-315	Ea

Professional Grade 8.8 mil (1.88" X 60 yd)

- Industrial-grade duct tape for splicing, masking, patching, sealing, and seaming
- Long term repairs
- High tensile strength for a secure hold under stress
- Thick rubber adhesive bonds to most rough and smooth surfaces for a tight seal
- Silver polyethylene surface resists wear, abrasion, and water
- Good choice for hanging polyethylene drapes for containment activities



Part #	Qt
380-316	Ea

Shop Supplies

Scotch® Performance Green Masking Tape 233+

Details

- Premium paper backing resists breaking, lifting, and edge curl for ease of use and less material waste
- Developed to provide high conformability with clean removal and sharp paint lines
- Superior resistance to UV, moisture, and solvents compared to other paper tapes
- Release coating minimizes unwind force, reducing wrinkling and paint blow-by

Our Scotch® Performance Green Masking Tape 233+ delivers consistently superior performance on moldings, plastic, glass, metal, rubber and paint. Balanced four-part construction includes flexible backing that applies easily around vehicle curves and contours and our patented adhesive that sticks at a touch, stays put and removes without transfer for consistently outstanding paint lines.



Part #	Item	Size	Qt
380-320	3/4 X 60 YD	Green	Ea
380-325	1" X 60 YD	Green	Ea
380-327	1-1/2" X 60 YD	Green	Ea
380-330	2" X 60 YD	Green	Ea

Skid Wrap Industrial Strength

18" Stretch Film/Wrap 1500 feet 7 Layers 80 Gauge Industrial Strength up to 800% Stretch 20 Microns Clear Cling Durable Adhering Packing Moving Packaging Heavy Duty Shrink Film (1 Roll, Clear)

Part #	Item	Qt
382-184	18" x 1500 ft	Ea



Shop Supplies

Waterproof Reflective Conspicuity Tape

Ultra Reflective: This reflective tape is made of a new material combined with coating, compounding and embossing technology, also using the combination of micro glass beads technology and microprisms technology to create a highly reflective surface. And its hexagons pattern makes the reflective effect more obvious.

Durability : This tape is designed to resist rain and sun-fading. It is wear resistant and water resistant making it last for long. And It forms a strong bond with the surface to ensure it doesn't disappoint you. Its generous size means whether it is on a guardrail or a trailer, it got you covered.

Safety: This conspicuity tape is for various vehicles to enhance night visibility and detection distance, avoiding more traffic accidents.

Application: This is a tape that can be used widely on cars and truck. It can also be used on construction signs and temporary signs on the roads for night physical activities. In addition to that, it can be efficiently used in guide and traffic facilities signs.



Part #	Item	Qt
380-375	2" X 100 ft	Ea
380-380	2" X 160 ft	Ea



Shop Supplies

Packing Tape Dispenser

- Comfortable “Pistol Grip” design

Part #	Item	Size	Qt
380-410	Dispenser	2”	Ea
380-412	Dispenser	3”	Ea



Packing Tape Premium 2.6 mil Heavy Duty

- Tensile Strength: 26 lb/in
- Adhesion: 24 oz/in
- Available clear

Part #	Item	Size	Qt
380-360	2.6 mil	2” x 55 yd	Ea
380-362	2.6 mil	3” x 55 yd	Ea



Packing Tape 1.8 mil General Duty

- Features Production grade pressure sensitive Carton Sealing Tape
- Generally is used for box sealing applications
- Construction provides a good closure for lightweight boxes



Part #	Item	Size	Qt
380-350	1.8 mil	2” x 110 yd	Ea
380-355	1.8 mil	3” x 110 yd	Ea

Double Sided– Polyester – Acrylic Adhesive Tape

- Great as a Banner Hem tape in graphics industry. Adhesive is plasticizer resistant and doesn't deteriorate on soft vinyl – holds true for long life
- Hand-tearable and conformable high-end, clear tape featuring a 0.5 mil polyester with a heavy mass of solvent based acrylic adhesive coating carried on a paper liner
- Extremely aggressive adhesive ensures adhesion to a wide variety of smooth and textured surfaces. Capable of bonding low surface energy substrates
- Superior resistance to heat, UV exposure, and aging
- Temperature range: -40°F to 225°F
- Tape Thickness: 6.5
- Adhesion: 179 oz/in



Part #	Item	Qt
380-450	1” x 36 yd	Ea

Shop Supplies

Plastic Coated Service Bulbs

Shatter resistant Tough-Skinned service light bulb has multiple support filaments to prevent premature burnout from the constant movement and vibration encountered in commercial and industrial applications. The silicone coating around the bulb provides added shatter containment, with an average life of 10,000 hours. When safety is a concern, shatter resistant light bulbs are the only option.



Part #	Item	Qt
382-022	75 Watt	6/PK
382-023	100 Watt	6/PK

Wire Plugs and Connectors

- Heavy duty polypropylene 15 amp Replacement Plugs and Connectors



382-550



382-555

15 Amp / 125 Volts / 1250
Watts

Part #	Item	Qt
382-550	Male 3-Wire	Ea
382-555	Female 3-Wire	Ea

Shop Supplies

60 Led Rechargeable Shop Light

2-in-1 LED Task Light w/Adjustable Hanger - Rechargeable

Rechargeable all LED 2-in-1 Task Light is a very versatile work light. It is actually two lights in one...a spotlight and a floodlight. Rated at 12 lumens, the spotlight beam on this light puts a beam of light exactly where you need it. This unique work light also has a non-focused 120 lumens floodlight built into the handle. Because the floodlight does not have a reflector, the light is unfocused and spreads out in a wide even pattern of light expressly for the purpose of providing illumination of areas that are close by. Now you have two completely different patterns of light for whatever work needs to be done...a spotlight for locating the problem, and a floodlight for lighting up the area while the problem is being fixed. The ergonomic shape of the handle makes it easy to hold, and the flat-bottom design means it will stand up on virtually any flat surface. For additional hands-free options, the work light includes a Hook/Prop Stand. It can be used to hang the work light up, and then pointed to exactly where it's needed. When the light is laid on its side, the hook can act as a "prop" stand to point the light where it will do the best job. Powered by an integrated nickel metal hydride battery, the spotlight will run for 24 hours, the floodlight for 4. This work light includes both an AC and a DC charger/power supply.

Features

- Has both a spotlight and a floodlight
- Ergonomic shape to the handle makes it easy to hold and use
- Flat bottom base make it possible to stand the light up for hands-free use
- The integrated hook/prop stand further increase the hands-free options
- Bright white LEDs with a 35,000 hour life
- Single rocker switch design up for spotlight, down for floodlight
- Integrated Nickel Metal Hydride (NiMH) battery
- Includes AC & DC power supply/charger

Flashlight



Floodlight



Dual-Light



120 Lumens



Part #	Item	Qt
382-910	LED	Ea

Shop Supplies

RAYOVAC

ULTRA PRO™ Alkaline Batteries



MADE IN THE USA
with U.S. and global parts

ULTRA PRO™

10 YEAR POWER GUARANTEE In Storage

(5 years for 9V)**



Smart Seal

A highly engineered seal that allows more space for active ingredients.



Max Capacity Can

Highly efficient case for safely containing and delivering maximum power.

Rayovac Alkaline Batteries

Part #	Item	Qt
383-025	AAAA	8
383-030	AAA	8
383-035	AA	4
383-045	C	6
383-050	D	6
383-052	9V	6



AAAA Batteries



C Batteries



AAA Batteries



D Batteries



AA Batteries



9V Batteries

Shop Supplies

Crossfire Cirrus Premium Gold Mirror/Burnt Orange Frame

Features

- Adjustable Rubber Nosepiece for added comfort
- Sleek, One-Piece Lens Design for a full field of vision
- Hard coat polycarbonate lens protects against scratches
- Provides 99.9% UVA and UVB protection
- Complies with ANSI Z87.1 standards



(39812) Part # 998-250

Crossfire Cirrus Premium Smoke Lens/Matt Black Frame



(39221) Part # 998-252

Crossfire Cirrus Premium Red Mirror Lens/Shiny Black Frame



(3968) Part # 998-256

Shop Supplies

Crossfire Lens Red Mirror/Black Frame

Features

- Rubber Nosepiece for all day comfort
- Adjustable Wired Temples for custom fit
- Hard coat polycarbonate lens protects against scratches
- Provides 99.9% UVA and UVB protection
- Complies with ANSI Z87.1 standards



(R-12620) Part # 998-204

Crossfire Talon Red Mirror/Copper Frame

Features

- Vented Rubber Nosepiece for comfort and breathability
- Rubber Insert Temple Grips for a snug fit
- Hard coat polycarbonate lens protects against scratches
- Provides 99.9% UVA and UVB protection
- Complies with ANSI Z87.1 standards



(R-119) Part # 998-230

Crossfire Infinity Premium Gold Mirror Orange/Black Frame

Features

- Vented Rubber Nosepiece for breathability
- Dual Mold, Rubber Temple Grips for better stability
- Hard coat polycarbonate lens protects against scratches
- Provides 99.9% UVA and UVB protection
- Complies with ANSI Z87.1 standards



(R-2812) Part # 998-226

Shop Supplies

RadiansT-71 Glass Silver Frame Clear Indoor/Outdoor Lens

Features

- Non-slip rubber temples for maximum comfort
- Polycarbonate lens provides impact resistance
- Soft rubber brow guard provides comfort and protection
- Adjustable Nosepiece
- Meets ANSI Z87.1 Standards and Provides 99.9% UVA/UVB Protection



(R-T71-90D) Part # 998-210

Radians Passage Clear Anti-Fog Lens

Features

- Lightweight frame provides a comfortable fit
- Flexible temples with rubber temple pads for a comfortable, non-slip fit
- Seamless one piece design
- Polycarbonate lens provides impact resistance
- Meets ANSI Z87.1 standards
- Provides 99.9% protection against harmful UV rays



(R-PS0111ID) Part # 998-212

Radians Passage Smoke Lens



(R-PS0120ID) Part # 998-216

Radians Passage Clear Indoor/Outdoor Lens



(R-PS0190ID) Part # 998-214

Shop Supplies

Radians Revelation Polarized Lens/CAMO Frame

Features

- Cushioned, non-slip rubber temple pads & rubber nose piece allows for all day comfort
- Unique hidden hinge temple design
- Comes standard with neck cord
- Protective lenses are coated for scratch resistance
- Safety glasses meets ANSI Z87.1 + standards & provides 99.9% UVA/UVB protection



Polarized

(RV4MPOID) Part # 998-132

Radians Revelation Smoke Polarized Lens



(RV01POID) Part # 998-136

Radians Rock Anti-Fog Silver Frame/Smoke Lens

Features

- Rubber temples wraparound for non-slip comfort
- Adjustable rubber nosepiece provides all day comfort
- Wraparound single lens provides an unobstructed field of vision
- Frame colors Silver
- Polycarbonate lens provides impact resistance
- Meets ANSI Z87.1 standard
- Provides 99.9% protection against harmful UV rays



(RK6-21) Part # 998-140

Radians Rock Anti-Fog Silver Frame/Clear Lens



(RK6-11) Part # 998-144

Shop Supplies

Radians Rad-Infinity Silver Frame/Green Mirror Lens

Features

- Cushioned, non-slip rubber temple pads & rubber nose piece allows for all day comfort
- Unique hidden hinge temple design
- Comes standard with neck cord
- Protective lenses are coated for scratch resistance
- Safety glasses meets ANSI Z87.1 + standards & provides 99.9% UVA/UVB protection



(R-IN6-GR) Part # 998-436

Radians Rad-Infinity Black Frame/Smoke Lens



(R-IN1-20) Part # 998-426

Radians Rad-Infinity Blue Frame/Blue Mirror Lens



(R-IN2-70) Part # 998-434

Radians Rad-Infinity Silver Mirror Lens



(R-IN1-60) Part # 998-430

Shop Supplies

Radians Mirage Clear Lens

Features

- Cushioned, non-slip rubber temple allows for all day comfort
- Unique hidden hinge temple design
- Protective lenses are coated for scratch resistance
- Safety glasses meets ANSI Z87.1 + standards & provides 99.9% UVA/UVB protection



(R-MRO110ID) Part # 998-302

Radians Mirage Clear Anti-Fog Lens



(R-MRO111ID) Part # 998-304

Radians Mirage Smoke Anti-Fog Lens



(R-MRO120ID) Part # 998-306

Shop Supplies

Radians Serrator Clear Lens

The lightweight design of the Radians Serrator™ Safety Glass is designed for a comfortable fit with excellent protection. The soft, rubber nosepiece and lightweight, flexible temples allow for an extremely comfortable fit.

Features

- Sleek, Lightweight Design for a comfortable fit
- Soft, rubber nosepiece for all day comfort
- Hard coat polycarbonate lens protects against scratches
- Provides 99.9% UVA and UVB protection
- Complies with ANSI Z87.1 standards



(SE1-10) Part # 998-330



(SE1-20) Part # 998-324

Radians Mirage RT™ Safety Eyewear

Radians Mirage RT™ Safety Eyewear offers a sleek design which allows for a perfect fit. Rubber tipped temples keep safety glasses secure. The Mirage™ family of safety eyewear is available in several styles, including rubber temples, foam lined and small sizes for all your safety glass needs



(MRR-110ID) Part # 998-294



(MRR-190ID) Part # 998-295

Indoor / Outdoor Lens



(MRR-120ID) Part # 998-296

Shop Supplies

Radians C-2 Bi-Focal Glaases

The Radians C-2™ Bi-Focal safety glass has a magnification diopter molded into the lens to combine a protective safety glass with reading glasses.

- Magnification diopter.
- Stylish Translucent Frame.
- Soft, rubber nose piece.
- Cushioned, non-slip rubber temple pads provides superior comfort.
- Polycarbonate protective safety lens provides impact resistance.



CLEAR	SUN	Magnifier	Qt
998-550	998-559	1.5	Ea
998-552	998-560	2.0	Ea
998-554	998-562	2.5	Ea
998-556	998-564	3.0	Ea

Radians RSB Bi-Focal Glasses

Radians Rad-Sequel RSx™ Bi-Focal safety glass has a magnification diopter molded directly into protective safety lens. No need for additional prescription reading glasses!

- Magnification diopter molded directly into protective safety lens.
- Cushioned, non-slip rubber tipped temples provide a secure fit.
- Soft, rubber nose piece provides all day comfort.
- Lightweight design provides a comfortable fit.
- Polycarbonate protective safety lens provides impact resistance.
- Meets or exceeds ANSI Z87.1 + standard.



CLEAR	SUN	Magnifier	Qt
998-602	998-615	1.5	Ea
998-606	998-616	2.0	Ea
998-608	998-618	2.5	Ea
998-610	998-620	3.0	Ea

Shop Supplies

PVC Dotted Gloves

These premium-weight, 8-ounce, cotton canvas gloves provide black PVC dots on the palm for better grip, a knit wrist to keep out dirt,



Part #	Item	Size	Qt
387-096	Canvas	L	12
387-100	Brown Jersey	L	12

Standard Poly/Cotton Brown Jersey Gloves

Soft, comfortable Brown Jersey Gloves are great for general duty and light abrasion applications



Part #	Item	Size	Qt
387-102	Brown Jersey	L	12

Standard Poly/Cotton Brown Jersey Gloves with Red Knit Wrist

Brown jersey glove with added comfort and warmth of a brushed fleece lining and knit wrist.



Part #	Item	Size	Qt
387-104	Brown Jersey	XL	12

Premium Split Cowhide Palm Rubberized Cuff Gloves

Select split cowhide leather work gloves feature a reinforced knuckle strap for better protection and shirred elastic at wrist for a comfortable fit. Wing thumb construction. 2 1/2" rubberized safety cuff.



Part #	Item	Size	Qt
387-109	Leather Palm	L	12

Shop Supplies

RADIANS RWG5100 GRAY SPLIT ECONOMY SHOULDER COWHIDE LEATHER WELDING GLOVE

The Radians RWG5100 leather welding glove offers a gray split economy shoulder cowhide leather construction, fleece cotton drill lining, wing thumb, reinforced palm, and 14" one-piece back.



Features

- Gray split economy shoulder cowhide leather
- Fleece cotton drill lining
- Wing thumb
- 14" one-piece back

Part #	Item	Size	Qt
387-225	WELDER GLOVE	XL	pair

6 mil Nitrile Gloves

- Powder-Free Nitrile Disposable Gloves
- Natural Rubber Latex Proteins
- The textured grip allows for superior holding.
- 6 Mil. Nitrile consistency allows resistance to puncture and abrasion .
- 100 individual gloves per box / 10 boxes per case

BLACK 6 ML NITRILE

Part #	Item	Qt
387-124	Small	100
387-125	Medium	100
387-126	Large	100
387-127	X Large	100
387-128	XXL Large	100



BLUE 6 ML NITRILE

Part #	Item	Qt
387-115	Small	100
387-116	Medium	100
387-117	Large	100
387-118	X Large	100
387-119	XXL Large	100



Shop Supplies

Mechanics Gloves

Features:

- Synthetic Leather Imported
- Thermal plastic rubber (tpr) hook and loop cuffs for easy on and off
- Smooth surface thumb and index finger point of contact for exceptional dexterity
- Fingertip pattern reduces seams and
- enhances finger tip sensitivity



Part #	Item	Qt
387-514	Medium	Pair
387-515	Large	Pair
387-516	XL Large	Pair
387-517	XXL Large	Pair

Dewalt Performance Gloves

The DEWALT DPG780 Performance Mechanic Work Glove provides superior grip where you need it most. The impact guards help protect from incidental bumps or scrapes while maintaining flexibility and comfort.



Features

- SecureFit™ Wrist Closure
- Tacky Silicone Fingertip Grips
- TPR Impact Guards
- PVC Palm & Saddle Overlays
- Durable Rubber Pull Tab

Part #	Item	Qt
387-525	Large	Pair
387-526	X Large	Pair
387-527	XXL Large	Pair

Shop Supplies

Radians Microdot Foam Nitrile Gripper

- The Radians RWG11 Microdot Foam Nitrile Gripper Glove with a blended nylon/spandex shell.
- The elastic cuff provides a comfortable, slip-on fit while the foam dipped microdot palm provides durability and a slip-free grip.
- Blended nylon/spandex shell.
- Foam nitrile microdot dipped palm.
- Elastic slip-on cuff



RWG11

Part #	Item	Qt
387-541	Medium	Pair
387-542	Large	Pair
387-543	X Large	Pair
387-544	XXL Large	Pair

Radians 3/4 Foam Dipped Dotted Nitrile

- The Radians RWG12 is a 3/4 foam dipped dotted nitrile glove with a blended nylon/spandex shell.
- The elastic cuff provides a comfortable, slip-on fit while the foam dipped palm with microdot pattern provides durability and a slip-free grip.
- Blended nylon/spandex shell.
- 3/4 Foam nitrile dipped palm.
- Elastic slip-on cuff.
- Meets EN 388:2003 standards for abrasion, cuts, tear and puncture (4 1 2 1).



RWG12

Part #	Item	Qt
387-553	Medium	Pair
387-554	Large	Pair
387-555	X Large	Pair
387-556	XXL Large	Pair

Shop Supplies

Radians Foam Nitrile Gripper Glove

- The Radians RWG13 is a foam dipped nitrile glove with a blended nylon/spandex shell.
- The elastic cuff provides a comfortable, slip-on fit while the foam dipped palm provides durability and a slip-free grip.
- Blended nylon/spandex shell.
- Foam nitrile dipped palm.
- Elastic slip-on cuff.
- Meets EN 388:2003 standards for abrasion, cuts, tear



RWG13

Part #	Item	Qt
387-563	Medium	Pair
387-564	Large	Pair
387-565	X Large	Pair
387-566	XXL Large	Pair

Radians Smooth Nitrile Palm Coated Glove

- The Radians RWG15 is a lightweight, smooth nitrile palm coated glove with a 13 gauge black polyester shell.
- The elastic cuff provides a comfortable, slip-on fit while the smooth nitrile palm coating provides excellent protection from abrasion in wet or dry applications, reducing hand fatigue.
- 13 gauge black polyester shell.
- Gray smooth nitrile palm coating.
- Seamless elastic slip-on cuff.
- Lightweight, excellent dexterity.
- Tested to EN388 standards for abrasion, cuts, tear and puncture (4 1 2 1).



RWG15

Part #	Item	Qt
387-571	Medium	Pair
387-572	Large	Pair
387-573	X Large	Pair
387-574	XXL Large	Pair

Shop Supplies

All Weather Hi-Visibility Gloves

The Radians RWG22 Hi-Viz work glove provides excellent protection from tear and abrasion. The seamless design of the 13 gauge polyester shell with the polyurethane dipped palm provides excellent protection and a comfortable fit in hazardous applications.

Applications: Construction, Assembly, Automotive, General Purpose, Manufacturing, Shipping, Warehousing



RWG22

Part #	Item	Qt
387-586	Medium	Pair
387-587	Large	Pair
387-588	X Large	Pair
387-589	XXL Large	Pair

Features

- 13 gauge Hi-Viz Yellow Polyester Shell provides cut resistance.
- Polyurethane palm dip provides protection from abrasion in wet or dry conditions.
- Seamless design provides a comfortable fit.
- ASTM Abrasion Level 2.
- Meets EN 388:2003 standards for Abrasion Resistance, Blade Cut, Tear, and Puncture (3 1 3 1).



Nationwide First Aid Service and Programs

COMPLETE
FIRST AID
SYSTEMS



BRINGING
SAFETY TO THE
WORKPLACE



4 Shelf Cabinet, Full With Door Pocket

4 shelf First Aid Cabinet is an excellent cabinet for industrial and medium sized businesses. Provides protection for minor cuts, abrasions, burns, trauma, personal discomfort and sprains.

Full Kit	Item	Empty
995-060	3-shelf	995-050
	4-shelf	995-055
	5-shelf	995-056



Full Kit	Item	Empty
995-038	24 unit	995-025
995-040	36 unit	995-026
995-041	36 unit metal	995-027

Pain Terminator

Immediately Relieves Pains Due To:

- backache
- headaches
- colds
- toothache
- minor arthritis pain
- muscular aches
- menstrual cramps



Part	Size
995-125	250 bx
995-126	100/bx

Ibuprofen

Immediately Relieves Pains Due To:

- headache
- muscular aches
- minor pain of arthritis
- toothache
- backache
- common cold
- menstrual cramps
- temporarily reduces fever



Part	Size
995-140	250 bx
995-141	100/bx

Sinu-Phen Plus

Immediately Relieves Pains

Helps:

- decongest nasal and sinus passages
- temporarily relieve stuffy nose and sinus pressure
- minor aches, pains, and fever



Part	Size
995-131	100/bx

Non-Asprin

Immediately Relieves Pains Due To:

- headache, muscular aches
- common cold
- minor pain of arthritis
- Toothache
- Menstrual Cramps
- temporarily reduces fever



Part	Size
995-146	100/bx

Cold Term Max

Immediately Relieves These Cold Symptoms:

- minor aches and pains
- headaches
- nasal congestion
- helps loosen phlegm (mucus)
- thins bronchial secretions
- reduces fever



Part	Size
995-135	100/bx

Polaris-Mint Antacid

Immediately Relieves Pains Due To:

- heartburn
- sour stomach
- upset stomach
- acid indigestion



Part	Size
995-155	100/bx

Cherry Cough Drops

Immediately Relieves:

- cough due to cold
- minor throat irritation
- makes nasal passages clear



Part	Size
955-175	50/bx

Throat Lozengers

Features:

- Soothes sore throats
- Great tasting flavor
- Relieves scratchy, irritated throats and sore mouths
- Pectin lozenge, oral demulcent
- Wild Cherry flavor,



Part	Size
995-180	25/bx

Plastic Bandages

Latex free, comfortable with a long-lasting adhesive.



Part	Size	Qty
955-220	1"	100

Light-Flex Strip Bandages

Light-Flex fabric bandages are perfect for an office and working environment or when a lighter bandage is needed to allow extra dexterity and comfort.



Part	Size	Qty
995-230	7/8 x 3"	50
955-228	7/8 x 4-1/8	30

Light-Flex Knuckle / Patch Bandages

Light-Flex fabric bandages are perfect for an office and working environment or when a lighter bandage is needed to allow extra dexterity and comfort



Part	Size	Qty
995-240	Knuckle	40
955-250	Patch	25

Light-Flex Finger-Tip Bandages

Light-Flex fabric bandages are perfect for an office and working environment or when a lighter bandage is needed to allow extra dexterity and comfort



Part	Size	Qty
995-235	Small Tip	40
955-245	Large Tip	25

Heavyweight Fabric Strip Bandages

This line of Extra Heavyweight bandages is the undisputed heavyweight champion! Made with a high quality, thick durable cloth, and a latex-free adhesive that outlast them all.



Part	Size	Qty
995-232	7/8 x 3	50

Heavyweight Finger-Tip Fabric Bandages

This line of Extra Heavyweight bandages is the undisputed heavyweight champion! Made with a high quality, thick durable cloth, and a latex-free adhesive that outlast them all.



Part	Size	Qty
995-252	Small Tip	40
995-254	Large Tip	25

Heavyweight Knuckle / Patch Bandages

This line of Extra Heavyweight bandages is the undisputed heavyweight champion! Made with a high quality, thick durable cloth, and a latex-free adhesive that outlast them all.



Part	Size	Qty
995-256	Knuckle	40
995-258	Patch	25

Blue Fabric Strip Bandages

Blue fabric non-metal detectable bandages with the same bright blue fabric for high visibility if lost during food preparation.



Part	Size	Qty
995-262	7/8 x 3	50

Blue Fabric Finger-Tip Bandages

Blue fabric non-metal detectable bandages with the same bright blue fabric for high visibility if lost during food preparation.



Part	Size	Qty
995-264	Small Tip	40
995-268	Large Tip	25

Blue Fabric Knuckle / Patch Bandages

Blue fabric non-metal detectable bandages with the same bright blue fabric for high visibility if lost during food preparation.



Part	Size	Qty
995-266	Knuckle	40
995-270	Patch	25

Burn-Free Products

When applied to a burn, skin temperature is immediately reduced, easing pain and protecting against contamination.



Part	Size	Qty
955-355	3.5 packet	25
995-835	3.5 packet	6
955-360	8" x 8"	Ea

Antibiotic / Alcohol / Antiseptic Wipes

Alcohol Wipes help clean and disinfect small wounds.

Antiseptic Wipes have a larger towelette to clean on and around the cut or wound.



Part	Size	Qty
995-320	Antibiotic	25
995-375	Antiseptic	25
955-380	Alcohol	50

First Aid Tapes



Part	Size	Qty
995-420	1/2" tape	Ea
955-425	3-cut tape	Ea
995-430	Woven tape	Ea



Gauze Pads



Part	Size	Qty
995-420	2 x 2 pads	10
955-425	3 x 3 pads	10
995-430	4 x 4 pads	10
995-600	3 x 5 gauze	Ea



Blood Stop Compress / Wound Seal

Powder + Pressure = Instant Scab

- Stops Bleeding
- Seals The Wound
- Scab Falls Off Naturally As Wound Heals



Part	Size	Qty
995-550	compress	Ea
955-560	wound seal	Ea

Pump Sprays

Convenient pump spray bottles for every need.



Part	Size	Qty
995-620	Burn	Ea
955-622	Antiseptic	Ea
955-624	Peroxide	Ea
955-626	Alcohol	Ea

Buffered Eye Wash

- Directions
- Twist top to remove.
- Flush the affected eye as needed, controlling the rate of flow of solution by pressure on the bottle

Active ingredients

benzalkonium chloride, edetate disodium, sodium chloride, sodium phosphate dibasic, sodium phosphate monobasic



Part	Size	Qty
995-650	4 oz	Ea
995-666	8 oz	Ea
995-664	16 oz	Ea
995-668	rack	Ea

Eye Wash Neutralizer Additive

Mix with clean potable water
One bottle (8 oz.) suitable for 14-16 gallons
30-month* shelf life (unopened)



Part	Size	Qty
995-673	8 oz	Ea
995-675	Eye cups	6pk

First Aid Tapes

Kit tweezers are flat edge for quick removal of objects



- Splinter out Tool
- Trip Bevel Designed for
- Loosening and
- Pulling Out Splinters

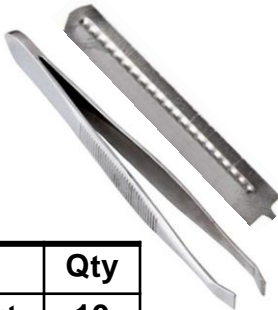

Part	Size	Qty
995-730	Splinter out	10
995-735	tweezers	Ea

Cotton Tips / Ice Packs CPR shield



Part	Size	Qty
995-740	Cotton tips	100
995-780	Ice pack	Ea
995-870	CPR shield	Ea

Finger Cots

- High-quality materials :
Made of 100% natural latex, powder-free, anti-static, keep clean and hygienic.
- Sturdy and durable : thick enough to handle everything you need, protect your finger from chemicals and scratches.



Part	Size	Qty
995-812	medium	144
995-813	large	144

Unit First Aid Items

Part	Size	Qty
995-780	Ice Pack	Ea
995-810	First Aid Guide	Ea
995-817	Nitrile Gloves	2 pr
995-821	Butterfly Closure	16
995-823	36 x 36 Compress	Ea
995-824	Elastic Bandage	16
995-826	Finger-Tips	10
995-828	Knuckles	10
995-830	4" Compress	Ea
995-831	Antiseptic Wipes	10
995-832	Antibiotic Cream	10
995-833	Hydrocortisone	10
995-834	Burn Cream	10
995-835	Burn Stop	6
995-838	Alcohol Wipes	10
995-840	Bee Sting Wipe	10
995-844	Triangle Bandage	Ea
995-847	3 x 3 Gauze Pads	4
995-870	CPR Shield	Ea
995-930	Rip-Flex Wrap 2x5	Ea
995-940	Rescue Blanket	Ea
995-950	Paramedic Shears	Ea
995-960	Finger Splint	Ea



Radians RADN95 Particulate Respirator

The RADN95 Particulate Respirator Includes a soft liner, adjustable nose clip, and comfortable straps to make it easy and comfortable to wear.

Soft liner.
Adjustable nose clip.
Comfortable straps.
Meets NIOSH N95 standards



Part	Size	Qty
996-315	RAD N95	20

Radians RADN95 Particulate Respirator with Arctic Valve™

The RADN95V Particulate Respirator quickly allows heat to dissipate with the help of the Arctic Valve™. The valve helps to keep glasses from fogging. It includes a soft liner, adjustable nose clip, and comfortable straps to make it easy and comfortable to wear.

Arctic Valve™ quickly dispels heat build-up in your mask when exhaling.
Reduces fogging on glasses.
Soft liner.
Adjustable nose clip.
Comfortable straps.
Meets NIOSH N95 standards



Part	Size	Qty
996-315	RAD N95V	20

Laser Light Ear Plugs



Self-adjusting Foam
 Expandable foam provides comfort and long term wear
 Each pair individually packaged in poly bags.
 32dB Noise Reduction Rating (NRR 32 dB)
 Qty: 200 Pairs

Part	Size	Qty
996-719	LL1 un-corded	25
996-720	LL1 un-corded	200
996-721	LL30 corded	25
996-722	LL30 corded	100

Radians Resistor® II Reusable Flanged Coded Earplugs

Tested to ANSI S3.19-1974 standards, this dielectric earplug has an NRR of 27. Its tapered design and sturdy stem allow for easy insertion and removal and a comfortable fit in the ear canal. Made from soft thermoplastic rubber (TPR), the FP42 and 43 are non-irritating to the skin. They are available uncoded (200 Box) and coded (100 Box) and in case quantities



Part	Size	Qty
996-735	FP42 un-coded	25
996-740	FP43 coded	25

Radians TRPX™ 29 Earmuff

Radians TRPX™ 29 Earmuff is premium hearing protection. Soft, lightweight, extra long padding on headband which offers added comfort for extended wear.



Part	Size	Qty
996-825	29 Black	Ea
996-827	29 High Visb	Ea

Shop Supplies

Emergency Eye Wash Station

Effectively and quickly clean debris from the eye, the Radians® 16 gallon REW01116 gravity fed Eyewash Station has a one second, one-step activation to deliver up to 15 minutes of non-injurious flow. It complies with ANSI Z358.1-2014 standards for portable eyewash stations.



EYEWASH STATION FEATURES:

Wall mounted 16 gallon gravity fed eyewash station

- Quick one-step activation for instantaneous flow
- Delivers at least 15 minutes of non-injurious flow
- Meets ANSI Z358.1 standard
- High visibility green color is easily recognizable if an injury occurs
- Includes an easy-to-mount wall bracket, portable water preservative, test log card and drainage hose
- Automatic Alarm System (REWALARM) sold separately

Part	Qty
996-120	Ea

ALARM FEATURES

Part	Qty
996-130	Ea

The optional alarm system adds another level of safety to the emergency eyewash station. When the station is activated, the alarm automatically alerts nearby workers that help is needed with a siren and flashing light. Easy installation



Shop Supplies

High-Density Industrial Trash Bag Liners

- Made from high-quality virgin resins for reliability and consistency.
- Star-sealed bottom distributes weight evenly and creates a seal up to eight times stronger than the film itself.

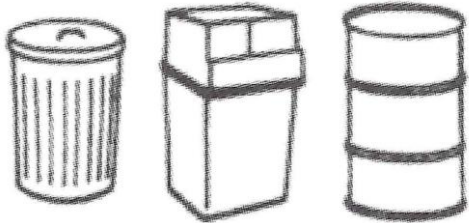

33 Gal 56 Gal 55 Gal



High-Density Heavy Duty Can Liner

Part #	Mfg Part #	Item	Size	Material	Qt
388-572	T-3339XH	33 Gal	33 X 40	22 mic (1.15 Gauge)	25
388-574	T-3858XH	55 Gal	38 x 58	22 mic (1.15 Gauge)	25

High-Density Extra Heavy Duty Can Liner

Part #	Mfg Part #	Item	Size	Material	Qt
388-586	T-3339XXH	33 Gal	33 X 40	1.65 Gauge	25
388-588	T-3858XXH	55 Gal	38 x 60	1.65 Gauge	25

Shop Supplies

Universal Interchange Design

Coupler Plug, Automotive, Tru-Flate Interchange Type, Brass, Brass Finish, 1/4 In. Hose Connection



Features

- Application: Air Hoses
- Finish: Brass
- Item: Coupler Body
- Temp. Range: -40 Degrees to 240 Degrees F
- Quick Connect Air Coupling Interchange Type: Tru-Flate-Automotive
- Quick Connect Air Coupling Hose Connection: (F)NPT
- Quick Connect Air Coupling Body Size: 1/4"
- Quick Connect Air Coupling Max. Pressure: 300 psi
- Quick Connect Air Coupling Material: Brass
- Quick Connect Air Coupling Product Grouping: Quick Coupler Body
- Quick Connect Air Coupling Seals: Buna-N
- Quick Connect Air Coupling Pipe Size: 1/4"

Part #	Item	Qt
389-680	1/4	Ea

Push Button Release Air Couplers 1/4 Series

1/4" Coupler
Coupler Push Button
1/4" FMNPT

Product features

- 1/4" Coupler
- Coupler Push Button
- 1/4" FNPT



Part #	Qt
389-710	EA

Push Button Release Air Couplers 3/8 Series

•3/8" Coupler
•Coupler Push Button
•3/8" FMNPT

Product features

- 3/8" Coupler
- Coupler Push Button
- 3/8" FNPT



Part #	Qt
389-714	EA

Shop Supplies

Industrial Interchange Design

Industrial Interchange Couplers

Part #	Body	Pipe Thread	Qt
389-720	1/4	1/4 Female Pipe	2
389-721	1/4	1/4 Female Pipe Brass	2
389-722	1/4	1/4 Male Pipe	2
389-724	1/4	3/8 Female Pipe	Ea
389-726	1/4	3/8 Male Pipe	Ea
389-744	3/8	3/8 Female Pipe	Ea
389-746	3/8	3/8 Male Pipe	Ea
389-748	3/8	1/4 Female Pipe	Ea
389-770	1/2	1/2 Female Pipe	Ea
389-772	1/2	1/2 Male Pipe	Ea



Industrial Interchange Plugs

Part #	Body	Pipe Thread	Qt
389-732	1/4	1/4 Male Pipe	5
389-734	1/4	1/4 Female Pipe	5
389-736	1/4	3/8 Male Pipe	5
389-738	1/4	3/8 Female Pipe	5
389-754	3/8	1/4 Male Pipe	2
389-756	3/8	1/4 Female Pipe	2
389-758	3/8	3/8 Male Pipe	2
389-760	3/8	3/8 Female Pipe	2
389-782	1/2	1/2 Male Pipe	Ea
389-784	1/2	1/2 Female Pipe	Ea
389-778	1/2	3/8 Male Pipe	Ea



Shop Supplies

ARO (medium Nose) Interchange Design

ARO Interchange Couplers

Part #	Body	Pipe Thread	Qt
389-810	1/4	1/4 Female Pipe	2
389-811	1/4	1/4 Female Pipe (Brass)	2
389-812	1/4	1/4 Male Pipe	2



ARO Interchange Plugs

Part #	Body	Pipe Thread	Qt
389-816	1/4	1/4 Male Pipe	5
389-818	1/4	1/4 Female Pipe	5



Lincoln (long Nose) Interchange Design

Lincoln Interchange Couplers

Part #	Body	Pipe Thread	Qt
389-912	1/4	1/4 Female Pipe	2
389-914	1/4	1/4 Male Pipe	2

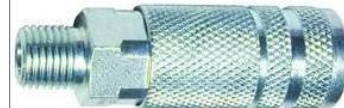

Lincoln Interchange Plugs

Part #	Body	Pipe Thread	Qt
389-904	1/4	1/4 Male Pipe	5
389-906	1/4	1/4 Female Pipe	5



Shop Supplies

Automotive Interchange Design

Automotive Interchange Couplers

Part #	Body	Pipe Thread	Qt
389-842	1/4	1/4 Female Pipe	Ea
389-844	1/4	1/4 Male Pipe	Ea
389-857	3/8	1/4 Female Pipe	Ea
389-858	3/8	1/4 Male Pipe	Ea
389-860	3/8	3/8 Female Pipe	Ea
389-862	3/8	3/8 Male Pipe	Ea
389-866	1/2	3/8 Female Pipe	Ea



Automotive Interchange Plugs

Part #	Body	Pipe Thread	Qt
389-850	1/4	1/4 Male Pipe	Ea
389-852	1/4	1/4 Female Pipe	Ea
389-854	1/4	3/8 Male Pipe	Ea
389-856	1/4	3/8 Female Pipe	Ea
389-882	3/8	1/4 Male Pipe	Ea
389-884	3/8	1/4 Female Pipe	Ea
389-886	3/8	3/8 Male Pipe	Ea
389-888	3/8	3/8 Female Pipe	Ea
389-894	1/2	3/8 Male Pipe	Ea
389-896	1/2	1/2 Male Pipe	Ea



Shop Supplies

Parker Industrial Type 6 Ball High Flow Brass Body Air Line Couplers

Features

6 ball locking mechanism gives increased reliability and longer service life over 3 ball mechanisms.

Tubular valve delivers high air flow with minimal pressure drop.

Precision molded Nitrile (Buna-N) seals form a “bubble tight” sea

Sleeve guard prevents accidental disconnect. Objects striking the coupler will not cause the sleeve to retract and disconnect the coupler.



Industrial Interchange Couplers

Part #	Body	Pipe Thread	Qt
389-926	1/4	1/4 Female Pipe	Ea
389-925	1/4	1/4 Male Pipe	Ea

Industrial Interchange Plugs

Part #	Body	Pipe Thread	Qt
389-935	1/4	1/4 Male Pipe	Ea
389-940	1/4	1/4 Female Pipe	Ea

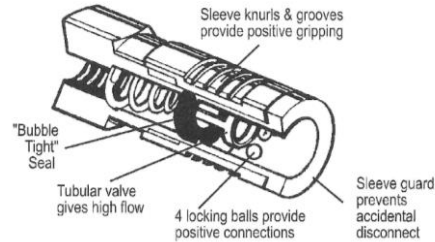

Parker Industrial Type 6 Ball High Flow Brass Body Air Line Couplers

Features

6 ball locking mechanism gives increased reliability and longer service life over 3 ball mechanisms.

Tubular valve delivers high air flow with minimal pressure drop.

Precision molded Nitrile (Buna-N) seals form a “bubble tight” seals.

Sleeve guard prevents accidental disconnect. Objects striking the coupler will not cause the sleeve to retract and disconnect the coupler.



Industrial Interchange Couplers

Part #	Body	Pipe Thread	Qt
389-958	3/8	3/8 Female Pipe	Ea
389-960	3/8	3/8 Male Pipe	Ea

Industrial Interchange Plugs

Part #	Body	Pipe Thread	Qt
389-966	3/8	3/8 Male Pipe	Ea
389-968	3/8	3/8 Female Pipe	Ea



Shop Supplies

Rubber/PVC Blended Air Hose

FEATURES

- Ideal for general purpose applications
- The blend of materials offers the best of both worlds – lighter in weight than rubber and more flexible than PVC
- Its bright florescent green color reduces chances of tripping while on a job site
- The bend restrictors reduce kinking and increase the life of the hose
- Three-year warranty



Amflo Air Hoses

Part #	Item	Hose End
393-175	3/8" X 50'	1/4 Male Pipe

- Heavy Duty Construction.
- Provides A Leak Proof Seal Between Gun and Air Line.
- Excellent For Blowing Out Cavities or Surfaces That Could Be Damaged or Scratched By Metal Tips.
- Die Cast Construction.
- LEVER HANDLE TYPE WITH HOOK (O.S.H.A.)
- LEVER HANDLE TYPE WITH HOOK (RUBBER TIPPED) TWO IN ONE AIR GUN METAL TIP PART No.
- Female Pipe AG164 1/4
- Aluminum Construction For Heavy Duty Services - Garages, Machine Shops and General Industry.
- Venturi Type Nozzle Increases Air Output By 10 Times.
- Cone Shaped Air Jet Minimizes Chip Blow Back.
- Brass Nozzle and Valve. • Flow: 11CFM
- MAXIMUM PRESSURE IS 145 P.S.I.



Air Blow Guns

Part #	Item	Qt
393-205	MAX 145 lb Safety Gun With Tip	Ea

Air Blow Guns

Part #	Item	Qt
393-202	Rubber Tip	2



Shop Supplies

Shop Air Hose Crimping Tool

Provides production capabilities and "big tool" crimping advantages at a much lower cost. Heavy duty ductile iron castings and hardened steel dies provide long service life and positive crimping. Includes five dies for crimping 1/4" braid to 3/8" double braided hose.



(amflo-855)

Part #	Qt
393-310	EA

Shop Air Hose Crimping Ferrules

Brass Ferrules

Part #	Item	Qt
393-323	.525	10
393-325	.550	10
393-326	.593	10
393-327	.625	10
393-328	.656	10
393-329	.675	10
393-330	.718	10
393-331	.750	10
393-332	.775	10
393-333	.812	10
393-345	.875	10
393-350	.900	10
393-355	.925	10



Pincher Tool

Part #	Item	Qt
394-590	Tool	EA



2 Ear Field Repair Kit

Part #	Item	Qt
394-600	kit	Ea

80 Clamps, Pincher and Field Box

Shop Supplies

Shop Air Hose Crimping Clamps

One Ear Clamps

Part #	Item	Range Inch	Range MM	Qt
394-602	HC8-2	.122 - .161	3.1 - 4.1	10
394-604	HC8-3	.118 - .197	3.0 - 5.0	10
394-606	HC8-4	.197 - .276	5.0 - 7.0	10
394-608	HC8-5	.276 - .354	7.0 - 9.0	10
394-610	HC8-6	.315 - .433	8.0 - 11.0	10
394-612	HC8-8	.433 - .512	11.0 - 13.0	10
394-614	HC8-9	.512 - .591	13.0 - 15.0	10
394-618	HC8-10	.591 - .708	15.0 - 18.0	10
394-620	HC8-12	.669 - .787	17.0 - 20.0	10
394-622	HC8-13	.748 - .866	19.0 - 22.0	10
394-624	HC8-14	.787 - .905	20.0 - 23.0	10
394-626	HC8-15	.866 - .984	22.0 - 25.0	10
394-628	HC8-16	.905 - 1.063	23.0 - 27.0	10
394-630	HC8-17	.984 - 1.102	25.0 - 28.0	10
394-632	HC8-18	1.063 - 1.220	27.0 - 31.0	10
394-634	HC8-21	1.220 - 1.339	31.0 - 34.0	10
394-636	HC8-23	1.339 - 1.457	34.0 - 37.0	10
394-638	HC8-24	1.457 - 1.575	37.0 - 40.0	10
394-640	HC8-26	1.575 - 1.693	40.0 - 43.0	10
394-642	HC8-28	1.693 - 1.811	43.0 - 46.0	10



Two Ear Clamps

Part #	Item	Item	Range Inch	Range MM	Qt
394-650	4-OET	HC9-2	.122 - .161	3.1 - 4.1	10
394-652	5-OET	HC9-3	.118 - .197	3.0 - 5.0	10
394-654	7-OET	HC9-4	.197 - .276	5.0 - 7.0	10
394-656	9-OET	HC9-5	.276 - .354	7.0 - 9.0	10
394-658	11-OET	HC9-6	.315 - .433	8.0 - 11.0	10
394-660	13-OET	HC9-8	.433 - .512	11.0 - 13.0	10
394-662	15-OET	HC9-9	.512 - .591	13.0 - 15.0	10
394-664	17-OET	HC9-9-1/2	.544 - .669	15.0 - 17.0	10
394-666	18-OET	HC9-10	.591 - .708	15.0 - 18.0	10
394-668	20-OET	HC9-12	.669 - .787	17.0 - 20.0	10
394-670	22-OET	HC9-13	.748 - .866	19.0 - 22.0	10
394-672	23-OET	HC9-14	.787 - .905	20.0 - 23.0	10
394-674	25-OET	HC9-15	.866 - .984	22.0 - 25.0	10
394-676	27-OET	HC9-16	.905 - 1.063	23.0 - 27.0	10
394-680	28-OET	HC9-17	.984 - 1.102	25.0 - 28.0	10
394-682	31-OET	HC9-18	1.063 - 1.220	27.0 - 31.0	10
394-684	34-OET	HC9-21	1.220 - 1.339	31.0 - 34.0	10
394-686	37-OET	HC9-23	1.339 - 1.457	34.0 - 37.0	10
394-688	40-OET	HC9-24	1.457 - 1.575	37.0 - 40.0	10
394-690	43-OET	HC9-26	1.575 - 1.693	40.0 - 43.0	10
394-692	46-OET	HC9-28	1.693 - 1.811	43.0 - 46.0	10



Shop Supplies

Hose Clamps

Type G Hose Clamps

These Clamps fit all standard automotive fuel injector hoses.
Approved for all O.E.M. applications, Zinc Plated



Part #	Auveco	Item	size	Qt
394-516	16766	5/16 – 3/8	8mm – 9.5mm	10
394-518	16767	3/8 – 29/64	9.5mm – 11.5mm	10
394-520	15860	13/32 – 1/2	10.5mm – 12.5mm	10
394-524	15861	1/2 – 9/16	12.5mm – 14.5mm	10
394-528	15862	17/32 – 39/64	13.5mm – 15.5mm	10
394-530	21256	19/32 – 11/16	15mm – 17.5mm	10

Spring Action Hose Clamps

Spring Steel, Heat Treated, Phosphate and Paint



Part #	Auveco	Hose I.D.	Color	Max Diam in Free Position	Width	Qt
394-542	12682	3/8"	Black	.321	5/16"	10
394-544	12683	7/16"	Green	.405	5/16"	10
394-546	12684	1/2"	Red	.460	5/16"	10
394-548	12685	9/16"	Black	.520	5/16"	10
394-550	12686	5/8"	Olive	.583	5/16"	10
394-552	12688	11/16"	Red	.655	5/16"	10
394-554	12689	3/4"	Black	.645	5/16"	10

Shop Supplies

Hose Clamps *Norma Torro (European Style) Phillip Hose Clamps*

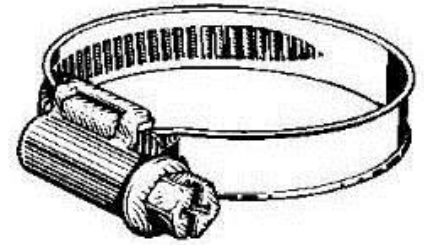

Unique off-set non-welded design of the housing provides resistance to over-tightening damage to the hose. The short housing saddle gives a smooth under side ensuring high sealing efficiency. These clamps are original equipment on both domestic and import vehicles. They are particularly suited for fuel, vacuum, water, emission and heater hoses and can be used with silicone hoses.

Part #	Clamping Range	Hex Size	Band Width	Qty
394-750	8mm-12mm (5/16"-1/2")	6mm*	8mm (5/16")	10
394-752	10mm-16mm (3/8"-5/8")	6mm*	8mm (5/16")	10
394-754	12mm-18mm (1/2"-3/4")	6mm*	8mm (5/16")	10
394-756	8mm-16mm (5/16"-5/8")	6mm	9mm (11/32")	10
394-758	12mm-20mm (1/2"-3/4")	6mm	9mm (11/32")	10
394-760	16mm-25mm (5/8"-1")	6mm	9mm (11/32")	10
394-762	20mm-32mm (3/4"-1-1/4")	6mm	9mm (11/32")	10
394-764	25mm-40mm (1"-1-5/8")	6mm	9mm (11/32")	10
394-766	30mm-45mm (1-3/16"-1-3/4")	6mm	9mm (11/32")	10
394-768	32mm-50mm (1-1/4"-2")	6mm	9mm (11/32")	10
394-770	40mm-60mm (1-5/8"-2-3/8")	6mm	9mm (11/32")	10
394-772	50mm-70mm (1-31/32" - 2-3/4")	6mm	9mm (11/32")	10
394-774	60mm-80mm (2-3/8" - 3-1/8")	6mm	9mm (11/32")	10
394-776	70mm-90mm (2-3/4" - 3-9/16")	6mm	9mm (11/32")	10

Shop Supplies

Hose Clamps

- **HEAVY-DUTY CLAMP DESIGN** - Heavy-duty four piece Quadra-Lock™ construction makes these clamps the ideal choice for demanding applications. Arcial slots in the bands give added strength against stripping.
- **QUADRA-LOCK™ CONSTRUCTION** - Housing is clinched at four points for extra strength and stability; clamp resists twisting and lifting during installation.
- **EASY INSTALLATION** - Quickly install clamps using a slotted screwdriver, nut driver or ratchet/socket wrench.
- **STREAMLINED DESIGN** - Low profile design is ideal for tight fitting enclosures; ensures that the clamp will not get hung up on surrounding components.
- **WIDE CLAMPING SURFACE** - Wide band creates higher sealing pressure with lower applied installed torques.

Regular Hose Clamps

- **CORROSION RESISTANT DESIGN** - Clinched design means there are no spot welds to rust, corrode or rupture.
- **STAINLESS STEEL COMPONENTS** – All hose clamps feature a stainless steel band and housing for increased performance.
- 1/2 wide stainless steel band.
- 5/16 hex head zinc plated screw.
- Arcial slots and buttress threads for smooth, positive action.
- Full 360° circle.
- Meets or exceeds SAE specifications.
- **MADE IN THE U.S.A. #4 thru #36**



Part #	Item	Size	Qt
395-004M	4 MINI	.22 - .63	10
395-005M	5 MINI	.44 - .69	10
395-006M	6 MINI	.33 - .88	10
395-008M	8 MINI	.44 - 1.00	10
395-006	06	.37 - .88	10
395-008	08	.43 - 1.00	10
395-010	10	.56 - 1.06	10
395-012	12	.56 - 1.25	10
395-016	16	.68 - 1.50	10
395-020	20	.75 - 1.75	10
395-024	24	1.06 - 2.00	10
395-028	28	1.31 - 2.25	10
395-032	32	1.56 - 2.50	10
395-036	36	1.81 - 2.75	10
395-040	40	2.06 - 3.00	5
395-044	44	2.31 - 3.25	5
395-048	48	2.56 - 3.50	5
395-052	52	2.81 - 3.75	5
395-056	56	3.06 - 4.00	5
395-064	64	2.50 - 4.50	5
395-072	72	3.00 - 5.00	5
395-080	80	3.50 - 5.50	5
395-084	84	3.75 - 5.75	5
395-088	88	4.00 - 6.00	5
395-104	104	5.00 - 7.00	5
395-116	116	5.75 - 7.75	5
395-128	128	6.50 - 8.50	5
395-152	152	8.00 - 10.00	5
395-165	164	8.75 - 10.75	5
395-170	200	11.00 - 13.00	5

Shop Supplies

Hose Clamps

- **HEAVY-DUTY LINER CLAMP DESIGN** - Heavy-duty four piece construction makes these clamps the ideal choice for demanding applications. Arcial slots in the bands give added strength against stripping.
- **QUADRA-LOCK™ CONSTRUCTION** - Housing is clinched at four points for extra strength and stability; clamp resists twisting and lifting during installation.
- **EASY INSTALLATION** - Quickly install clamps using a slotted screwdriver, nut driver or ratchet/socket wrench.
- **STREAMLINED DESIGN** - Low profile design is ideal for tight fitting enclosures; ensures that the clamp will not get hung up on surrounding components.
- **WIDE CLAMPING SURFACE** - Wide band creates higher sealing pressure with lower applied installed torques.
- **CORROSION RESISTANT DESIGN** - Clinched design means there are no spot welds to rust, corrode or rupture.
- **STAINLESS STEEL COMPONENTS** - All hose clamps feature a stainless steel band and housing for increased performance.
- **SILICONE LINER SERIES** – Protects soft silicone hose with an integral inner liner that covers the band perforations.
- 1/2 wide stainless steel band.
- 5/16 hex head zinc plated screw.
- Full 360° circle.
- Meets or exceeds SAE specifications.

Liner Hose Clamps



Part #	Item	Size	Qt
395-204	04	.31 - .56	10
395-206	06	.56 - .88	10
395-210	10	.65 – 1.06	10
395-212	12	.68 – 1.51	10
395-216	16	.75 – 1.50	10
395-220	20	1.37 – 1.81	10
395-224	24	1.50 – 2.00	10
395-228	28	1.75 – 2.25	10
395-232	32	2.00 – 2.50	10
395-236	36	1.81 – 2.75	10
395-240	40	2.06 – 3.06	5
395-244	44	2.31 – 3.25	5
395-248	48	2.56 – 3.56	5
395-252	52	2.81 – 3.75	5
395-256	56	3.12 – 4.06	5
395-260	60	3.31 – 4.25	5
395-264	64	3.56 – 4.50	5

Shop Supplies

WaveSeal 360 clamps are comprised of two main parts, the clamp assembly and the wave profile SmartLiner. The wave profile SmartLiner is high quality, thin gauge stainless steel specifically tempered to expand and contract with temperature variations. The clamp rides on SmartLiner so pressure is more evenly distributed around the hose. Applications include radiators, turbo charged applications, solar panels, vehicle HVAC, pipe fluid connectors, soft hose applications, generators, home appliances, tractors/trucks and most vehicle fluid applications.



Material Specifications

Screw: 5/16" Hex Head, 410 Stainless
 Housing: 300 Stainless
 Band: 9/16", 300 Stainless
 9/16" Spring Liner: 300 Stainless
 Installation Torque: **70 in-lbs** (7.9 Nm)

Applications include radiators, turbo charged applications, solar panels, vehicle HVAC, pipe fluid connectors, soft hose applications, generators, home appliances, tractors/trucks and most vehicle fluid applications.

WaveSeal 360 Assortment



4 EA,
 16,20,24,28,32,36,40,44,48

Part #	Size	Min	Max	Qt
395-278	16	1-3/32	1-9/32	5
395-279	20	1-1/8	1-9/16	5
395-281	24	1-1/2	1-13/16	5
395-282	28	1-3/4	2-1/16	5
395-283	32	1-15/16	2-5/16	5
395-285	36	2-1/8	2-9/16	5
395-287	40	2-5/16	2-13/16	5
395-289	44	2-1/2	3-1/16	5
395-291	48	2-11/16	3-5/16	5
395-292	52	3	3-1/2	2
395-293	56	3-1/16	3-13/16	2
395-294	60	3-1/4	4-1/16	2
395-295	64	3-7/16	4-5/16	2
395-296	72	3-3/4	4-13/16	2
395-297	80	4-3/16	5-5/16	2
395-298	88	4-1/2	5-13/16	2

Part #	Item
0395-30	360 Assortment

Shop Supplies

WaveSeal 380 clamps are comprised of two main parts, the clamp assembly and the wave profile SmartLiner. The wave profile SmartLiner is high quality, thin gauge stainless steel specifically tempered to expand and contract with temperature variations. The clamp rides on SmartLiner so pressure is more evenly distributed around the hose. Applications include radiators, turbo charged applications, solar panels, vehicle HVAC, pipe fluid connectors, soft hose applications, generators, home appliances, tractors/trucks and most vehicle fluid applications.



Material Specifications

Screw: 5/16" Hex Head, 410 Stainless
 Housing: 300 Stainless
 Band: 9/16", 300 Stainless
 9/16" Spring Liner: 300 Stainless
 Installation Torque: **100 in-lbs** (7.9 Nm)

Applications include radiators, turbo charged applications, solar panels, vehicle HVAC, pipe fluid connectors, soft hose applications, generators, home appliances, tractors/trucks and most vehicle fluid applications.

WaveSeal 380 Assortment



4 EA,
 16,20,24,28,32,36,40,44,48

Part #	Size	Min	Max	Qt
395-522	238	1.64	2.12	2
395-524	275	2.03	2.51	2
395-526	300	2.29	2.77	2
395-528	325	2.53	3.03	2
395-530	350	2.74	3.28	2
395-532	375	2.92	3.54	2
395-534	400	3.12	3.79	2
395-536	425	3.31	4.04	2
395-538	450	3.48	4.29	2
395-540	512	4.06	4.91	2
395-542	562	4.55	5.41	2
395-544	612	5.03	5.90	2

Part #	Item
0395-32	380 Assortment

Shop Supplies

Constant Torque Hose Clamps

- ELIMINATES COLD-FLOW LEAKAGE – Prevents leaks caused by temperature changes.
- AUTO ADJUSTING DIAMETER – Clamp automatically increases or decreases its diameter due to changes in operation or environment temperatures.
- CONSTANT TORQUE – Belleville spring washer mechanism provides a reliable and accurate constant tight fit without needed adjustments.
- DIFFICULT APPLICATIONS – Ideal where clamps are difficult to get at for re-tightening and potential leakage in the connection may occur.
- HEAVY EQUIPMENT – Recommended for bus, truck and heavy-duty equipment air intake & coolant connections.
- CORROSION RESISTANT – Heavy-duty stainless steel housing, 5/8" stainless steel band and 3/8" hex drive screw.
- MADE IN THE U.S.A.



Constant Torque Hose Clamps

Part #	Ideal #	Item	Qt
395-310	47010	#10 – 9/16 – 1-1/16	2
395-312	47012	#12 – 5/8 – 1-1/4	2
395-316	47016	#16 – 13/16 – 1-1/2	2
395-320	45175	1" – 1-3/4"	2
395-324	45200	1-1/4" – 2-1/8"	2
395-328		1-3/8" - 2-1/4"	2
395-332		1-9/16 – 2-1/2	2
395-336	45250	1-3/4" – 2-5/8"	2
395-340	45300	2-1/4" – 3-1/8"	2
395-344	45350	2-3/4" – 3-5/8"	2
395-348	45400	3-1/4" – 4-1/8"	2
395-352	45450	3-3/4" – 4-5/8"	2
395-356	45500	4-1/4" – 5-1/8"	2
395-360	45550	4-3/4" – 5-5/8"	2
395-364	45600	5-1/4" – 6-1/8"	2
395-368	45650	5-3/4" – 6-5/8"	2
395-372	45700	6-1/4" – 7-1/8"	2
395-376	45750	6-3/4" – 7-5/8"	2
395-380	45800	7-1/4" – 8-1/8"	2
395-384	45850	7-3/4" – 8-5/8"	2
395-388	45900	8-1/4" – 9-1/8"	2

Shop Supplies

Hose Clamps

- High clamping strength prevents leakage in heavy-duty applications.
- Ideal for water/air intake hose Systems, water pump suction/discharge hose, irrigation line connections.
- OEM approved and fleet specified.
- Smooth inner band protects hose.
- Recommended for bus, truck and heavy-duty equipment.
- High strength stainless steel band and one piece stainless steel trunion.
- Superior welded construction.
- Meets SAE J1508 for T-Bolt clamps.



Flex Seal Hose Clamps

Part #	Item	Qt
395-410	2.06 – 2.31	2
395-412	2.19 – 2.50	2
395-416	2.31 – 2.62	2
395-420	2.38 – 2.69	2
395-424	2.44 – 2.75	2
395-428	2.56 – 2.87	2
395-432	2.69 – 3.00	2
395-436	2.81 – 3.12	2
395-440	2.94 – 3.25	2
395-444	3.06 – 3.37	2
395-448	3.31 – 3.62	2
395-450	3.56 – 3.87	2
395-458	3.63 – 3.94	2
395-460	3.81 – 4.12	2
395-462	4.06 – 4.37	2
395-464	4.31 – 4.62	2
395-466	4.56 – 4.87	2
395-468	4.81 – 5.12	2
395-470	5.06 – 5.37	2



T-Bolt Hose Clamps

Part #	Item	Qt
395-492	1.31 – 1.56	2
395-493	1.56 – 1.81	2
395-494	1.69 – 1.94	2
395-495	1.81 – 2.06	2
395-496	2.06 – 2.31	2
395-497	2.19 – 2.50	2
395-498	2.31 – 2.62	2
395-499	2.38 – 2.69	2
395-500	2.44 – 2.75	2
395-501	2.56 – 2.88	2
395-502	2.69 – 3.00	2
395-503	2.81 – 3.12	2
395-504	2.94 – 3.25	2
395-505	3.06 – 3.37	2
395-506	3.31 – 3.62	2
395-508	3.56 – 3.87	2
395-510	3.63 – 3.94	2
395-512	3.81 – 4.12	2
395-513	4.06 – 4.37	2
395-514	4.31 – 4.62	2
395-516	4.56 – 4.87	2
395-517	4.81 – 5.12	2
395-518	5.06 – 5.37	2

Shop Supplies

Grease Coupler

AMFLO 05-030: Standard jaw-type coupler features spring-loaded ball check valve. Fits all 1/8" NPT threads. For hand operated lube equipment only. Recommended **working pressure is 4,500 PSI**. Length 1-7/16", width 5/8"



Part #	Qt
396-028	3

AMFLO 05-038: Designed for use with air powered equipment as well as hand guns. Heavy duty construction withstands higher pressures. 3 hardened jaws reverse for longer coupler life. 2" long coupler with 11/16" diameter is tapped for 1/8" pipe threads. Recommended **working pressure is 8,000 PSI**.



Part #	Qt
396-162	3

LINCOLN 5852 GREASE COULPER

- 6,000 psi (408 bar) maximum operating pressure
- For all hydraulic type grease fittings
- Small outside diameter permits easy contact with recessed fittings
- Built-in ball check prevents leak and lubricant backup
- Inlet 1/8 in. NPT(f)



Part #	Qt
396-050	3

LINCOLN 5845 GREASE COULPER

- 7500 psi max operating pressure
- 11/16 in. hex
- For all hydraulic type grease fittings
- Replaceable hardened steel jaws
- Built-in ball check prevents leak and lubricant backup
- Standard 1/8" NPT(F) inlet



Part #	Qt
396-060	3

Lock-N-Lube Grease Coupler

- Unique design. Locks on.....Stays on....No leaks! Four hardened spring steel jaws are resilient under high pressure - max 10,000 psi.
- Grease goes IN, not ON the machine. No more grease mess everywhere.
- Ends the waste. Ends the mess. Ends greasing frustration.
- Fits standard Grease Guns - 1/8" NPT fitting. Fits all SAE and Metric Grease fittings. Simply replace your existing coupler, click the orange button on the right to buy.



Part # 396-000

Part # 396-004 Repair Kit

Shop Supplies

Grease Coupler

GREASE SWIVEL (amflo 05-057gs)

Swivels in a full 360° circle and locks in place. 45° angle gives easy access to most grease fittings. Comes with 05-028 standard grease coupler and 1/8" female inlet for extension pipe.

For hand operated grease guns only.
Recommended working pressure is 4,500 PSI.



Part #	Qt
396-180	Ea

GREASE SWIVEL (amflo 05-052gs)

Swivels in full 360 degree circle and locks in place. 45 degree angle gives easy access to most grease fittings. 1/8" NPT female inlet.

For use with air operated equipment. Recommended working pressure is 6,000 PSI.



Part #	Qt
396-185	Ea

GREASE FILLING NEEDLE INJECTOR

- Grease Injector Needle PLEWS 05-037
- Easy to use
- Lubricates in very tight places such as universal joints and sealed bearings
- Stainless steel 18 gauge x 1-1/2 inch long needle
- Equipped with standard grease fitting and protective plastic holder
- For hand operated grease guns only



Part #	Qt
396-080	Ea

GREASE WHIP ASSEMBLY - RUBBER (GWR)

Applications:

These assemblies are manufactured from 3/16" I.D. S.A.E. 100R1 rubber hose. The one braid hose is permanently crimped with 1/8 brass male pipe couplings on both ends.

Recommended use: Hand held grease guns.

Grease Hose

Part #	Item	Qt
396-233	12" Whip Hose	Ea
396-236	18" Whip Hose	Ea
396-245	24" Whip Hose	Ea
396-247	36" Whip Hose	Ea



Shop Supplies

Grease Adapter

Grease Fitting Adapter 1/4-28SAE-LT x 1/8-27NPTF (F)

Lincoln Adapter, Straight, 1/4-28 SAE-LT Male x 1/8-27 NPTF Female, OAL: 0.87, Drive: 1/2 Hex, Steel, Zinc Clear L51942



Part # 396-190

Grease Fitting Tools

Drive Fitting Installation Tool Straight CS ZC

Heritage Grease Fitting Tool, Drive, Straight, Steel, Zinc Clear, OAL: 4.50, Use to Install Straight Drive Fittings.



Part # 396-206 (H83200)

Drive Fitting Installation Tool Angled CS ZC

Heritage Grease Fitting Tool, Drive, Angled, Steel, Zinc Clear, OAL: 4.50, Use to Install Angled Drive Fittings



Part # 396-208 (H83250)

GREASE FITTING EASY OUT TOOL

Removes 3/8" & 7/16" Hex Size Re-Taps 1/8" Pipe Threads Removes Broken 1/8" Pipe Threads

Part # 396-225



GREASE FITTING EASY OUT TOOL

Removes 5/16" & 3/8" Hex Size Re-Taps 1/4-28 Pipe Threads Removes Broken 1/4-28 Pipe Threads

Part # 396-227



Grease Caps

- Caps snap securely over fittings to seal out , moisture and corrosion.
- Built-in retaining ring keeps caps from being lost during servicing.
- Bright color code makes locating fittings faster and easier.
- Allows for color coding fittings to indicate type or frequency of lubrication.
- Ideal for protecting fittings on equipment to be painted.



Part #	Item	Qt
396-320	Black	25
396-322	Yellow	25
396-324	Red	25

Shop Supplies

Grease Fittings

Self Thread Cutting Grease Fittings

Part #	Item	Qt
396-325	1/4-28 Pipe	25
396-350	1/8 Pipe	25

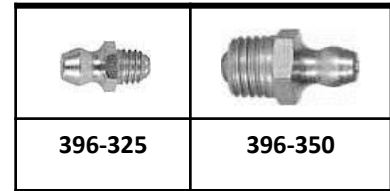

1/4-28 Grease Fittings

Part #	Item	Length	Qt
396-330	Short	35/64	50
396-335	Medium	11/16	25
396-337	Long	15/16	25
396-338	X-Long	1-1/8	25
396-340	45*	29/32	25
396-345	90*	3/4	25

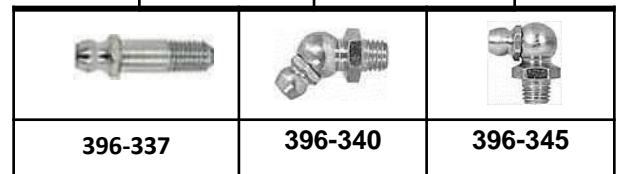
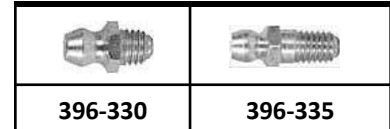

1/8 Pipe Grease Fittings

Part #	Item	Length	Qt
396-355	Short	11/16	25
396-360	Long	1-1/4	10
396-365	45*	29/32	25
396-367	65*	29/32	25
396-370	90*	27/32	25



1/4 Pipe Grease Fittings

Part #	Item	Length	Qt
396-385	Short	59/64	10
396-390	45*	1-1/16	10



Drive In Grease Fittings

Part #	Item	Length	Qt
396-415	3/16	Straight	25
396-430	1/4	Straight	25
396-470	5/16	Straight	25



Shop Supplies

Grease Fittings

Metric Grease Fittings

Part #	Item	Qt
396-520	6MM X 1.00 Straight	25
396-525	6MM X 1.00 45*	25
396-530	6MM X 1.00 90*	25
396-550	8MM X 1.00 Straight	25
396-555	8MM X 1.00 45*	25
396-560	8MM X 1.00 90*	25
396-564	8MM X 1.25 Straight	25
396-566	8MM X 1.25 45*	25
396-568	8MM X 1.25 90*	25
396-575	10MM X 1.00 Straight	25
396-580	10MM X 1.00 45*	25
396-585	10MM X 1.00 90*	25
396-586	10MM X 1.50 Straight	25

		
396-520	396-525	396-530
		
396-550	396-555	396-560
		
396-564	396-566	396-568
		
396-575	396-580	396-585
		
	396-586	

Metric Drive-In Grease Fittings

Part #	Item	Qt
396-590	6MM X 1.00 Straight	25
396-592	8MM X 1.25 Straight	25
396-594	10MM X 1.00 Straight	25

		
396-590	396-592	396-594

Shop Supplies

Grease Guns

Our Heavy duty grease gun for automotive professionals.

Painted Steel Barrel.

Made for the punishing day-in and day-out service required by industrial customers.

Variable/short stroke for easy use in confined areas.

Dual port head cap with bulk loader fitting for 3-way loading:

14 oz. cartridge, bulk or suction. 5-3/8" pipe and coupler.

Plated lever with comfortable oversized grip.

Develops up to 10,000 PSI.

Delivers 1 oz./22 strokes



Part # 397-000

Grease Gun, HD Pistol, Variable, w/18" Hose

Features variable stroke for use in tight places.

3-way loading:

14 oz. cartridge, bulk or suction.

18" flex hose with coupler,

Vinyl handle grip, air bleeder, and bulk loader fitting.

Develops up to 7,000 PSI. Delivers 1 oz./40 strokes.



Part # 397-002

Shop Supplies

Calking Guns

This professional gun

Is fabricated from die cast alloy and steel, both riveted and welded for maximum strength. It features a smooth hexagonal drive rod and precision catch plate for effortless action. The handle and trigger are designed for comfortable operation over a long period of use. Corrosion resistant orange epoxy powder coated.

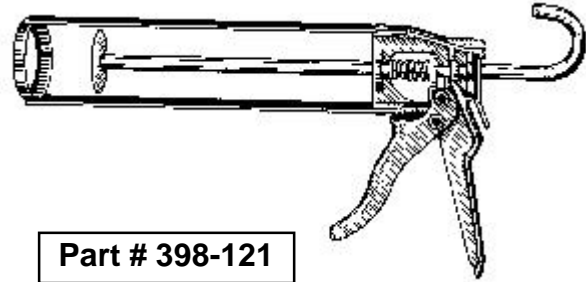

Part # 398-121

This deluxe heavy duty caulking gun

Ensures operator comfort and efficiency of use. It has a die-cast alloy, profiled hand grip for strength and lightness, which is contoured for use by all hand sizes and allows the use of smooth, full strokes. The advanced design of the drive mechanism has a patented catch plate system. Combined with use of a hardened steel drive rod, this prevents notching and scoring of the rod.

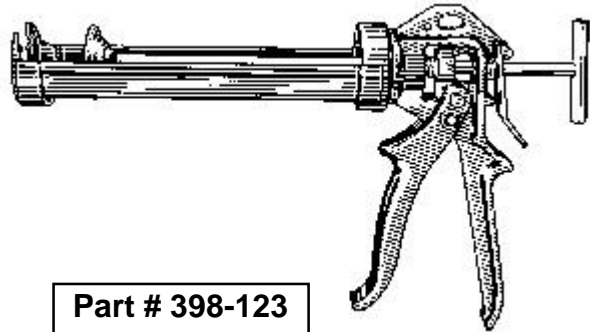

Part # 398-123

- Description : Tool
- Used for : Metric Slide Caliper

Part # 399-229



- Description : Tool
- Used for : Screw Gauge

Part # 399-244



Shop Supplies

Sprayers

The **Sure Shot A1000G Atomizer Sprayer** (Green) is an economical way to apply bulk chemicals like cleaners, degreasers, penetrating oils, solvents and lubricants. Instead of flammable and/or dangerous propellants, it uses readily available compressed air. This unit is reusable, so you don't have to worry about disposal of empty cans.

Features:

- Steel construction with brass nozzles and corrosion resistant working parts
- Can be used with bulk oil and solvent based materials
- General purpose mist and pin stream nozzle for multi-purposes
- Completely refillable and rechargeable, and capable of pressurizing up to 200 PSI of air
- Powder-coated finish for durability
- 32 oz. liquid capacity

Includes:

- 32 oz. Atomizer Sprayer (Green) - A1000G



Part # 398-225

Part #	Item	Qt
398-236	Repair Kit	Ea
398-238	Nozzle	Ea

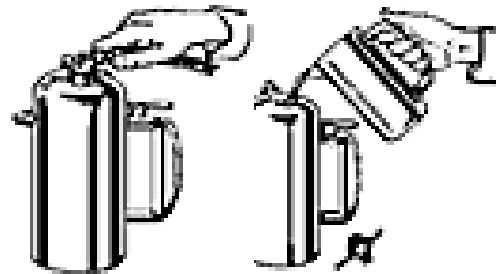

Titan Professional Hand Sprayer feature top quality construction with eye catching appearance. Titan Hand Tools are subject to rigid manufacturing specifications. Titan's thorough and consistent quality control procedures ensure that all Titan Professional Hand Tools will deliver consistent, exceptional performance.

Features:

- 80 - 150 PSI operating pressure
- Eco-friendly and refillable
- Not for use with paint products
- Do not use with flammable propellants
- Eliminates dangerous or harmful propellants

Includes:

- Spot Spray Non-Aerosol Sprayer - 19419



Part # 398-220

Shop Supplies

Tools

Welding Striker

Part #	Item	Qt
398-250	Striker	Ea
398-254	Flint	Ea



Gedu Air Die Grinder

With 1/4" and 1/8" Collets Air Compressor Tool, Air Straight Grinder

- Free Speed: 25,000 Rated R.P.M.
- ✓Size Capacity: 1/4" and 1/8" Collets
- ✓Compact and lightweight, Rear exhaust air flow system directs air away from work surface
- ✓Easy-to-use, integral safety-lock throttle lever prevents accidental start-up



Part #	Qt
389-500	EA



Gedu Air Die Grinder

With 1/4" and 1/8" Collets Air Compressor Tool, Air Angle Grinder (angle grinder)

- Free Speed: 25,000 Rated R.P.M.
- ✓Size Capacity: 1/4" and 1/8" Collets
- ✓Compact and lightweight, Rear exhaust air flow system directs air away from work surface
- ✓Easy-to-use, integral safety-lock throttle lever prevents accidental start-up



Part #	Qt
389-515	EA



Shop Supplies

Mini Die Grinder

Useful for finishing and detail work
Free Speed: 22,000 RPM
Recommended air pressure: 90 PSI
Air consumption: 4.0 CFM



Part #	Qt
389-520	EA

Mini Die Grinder

Useful for finishing and detail work
Free Speed: 22,000 RPM
Recommended air pressure: 90 PSI
Air consumption: 4.0 CFM



Part #	Qt
389-530	EA

Utility Cut-off Tool

Great for cutting sheet metal, muffler clamps, etc.
Free Speed: 22,000 RPM
Wheel Diameter: 3"
Air Consumption: 6.0 CFM



Part #	Qt
389-540	EA

Dewalt Impact Tool

FEATURES

Ring Magnet secures fastener, and helps to reduce slipping & wobble
True 90 degree head allows tight access when using 1" bit tip
5X longer life on average vs. Milwaukee 48-32-2100 in Milescraft 1302
IMPACT READY(R) performance - designed for use in impact drivers

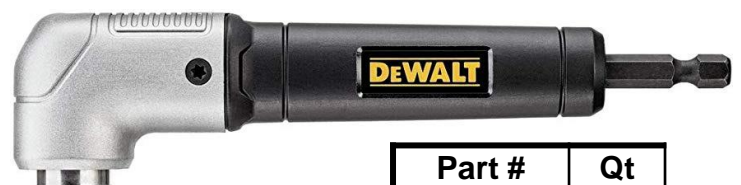

Part #	Qt
389-640	EA

Shop Supplies

Brighton-Best International Preferred® Hand Tools Limited Lifetime Warranty

Brighton-Best International (BBI) Preferred® Hand Tool products, except as otherwise specified, are warranted under normal use and service against defects in materials and workmanship. This warranty does not cover wear and tear from normal use or any damage or product failure caused in whole or part by misuse, abuse, or alteration as determined at BBI's sole judgment.

BBI MAKES NO OTHER WARRANTIES AND THIS LIMITED WARRANTY IS MADE IN LIEU OF ALL OTHER WARRANTIES, EXPRESS OR IMPLIED, INCLUDING THE IMPLIED WARRANTIES OF MERCHANTABILITY OR FITNESS FOR A PARTICULAR PURPOSE. AGENT, DISTRIBUTORS AND RETAILER OF BBI HAND TOOLS HAVE NO AUTHORITY TO MAKE ANY REPRESENTATIONS OR WARRANTIES OTHER THAN THOSE CONTAINED IN THIS WARRANTY.

YOUR SOLE AND EXCLUSIVE REMEDY FOR ANY BREACH OF THIS WARRANTY AS DETERMINED AT BBI'S SOLE DISCRETION SHALL EITHER BE THE REPAIR OR REPLACEMENT OF THE DEFECTIVE TOOL OR A REFUND OF THE MANUFACTURER'S SUGGESTED RETAIL PRICE. UNDER NO CIRCUMSTANCE WILL BBI BE LIABLE FOR CONSEQUENTIAL, INCIDENTAL, SPECIAL OR PUNITIVE DAMAGES OR DAMAGES TO PROPERTY LOSS OR PERSONAL INJURY. THESE TERMS AND CONDITIONS ARE SUBJECT TO CHANGE WITHOUT PRIOR WRITTEN NOTICE AT ANYTIME AND AT BBI'S SOLE DISCRETION

Exceptions

Consumable products that are reasonably expected to be worn out or damaged during use including but not limited to micrometer torque wrenches or bit sockets are warranted to the original purchaser only against defects in materials and workmanship for a period of one year after the date of purchase under normal use and service. This warranty does not cover wear from normal use, or any damage or product failure caused by misuse, abuse, alteration or improper maintenance of the tool. Proof of date of purchase will be required to redeem warranties for these products.

Claims Procedure

Please go to the BBI website and find "Hand Tool Warranty". Complete the application form and follow the instructions to print out the prepaid UPS shipping label. Carefully package the warranted product into a box so that the product is protected during shipment, insert the printed application form, apply the label and drop it off at any UPS store, and your warranty will be processed.

In most cases warranty claims are processed within 4-5 weeks, but in rare instances may take up to 8 weeks depending on product availability. If your warranty involves a ratchet or breaker bar please call first as it most likely can be fixed with a repair kit that we can send you.

For all other warranty inquiries, please contact: 1-800-275-0028 or email: preferredwarranty@brightonbest.com

Please take note that some states do not allow the exclusion or limitation or incidental or consequential damages, however this BBI warranty provides specific legal rights. Additionally, if you are a consumer, you may have other rights which may vary from state to state.

Please visit www.preferred.com for more product information.

Shop Supplies

Tools

Mini Scraper with razor sharp edge that cuts or scrapes paint, stickers, cardboard, string, etc. Flip a latch and turn the razor blade over to safely store the scraper.

Part #	Qt
401-015	5



retractable scraper that takes the aggravation out of getting old stickers off car windshields and paint blotches off windows. The scraper is 7-7/8" when fully open and locked in position. The razor blade holder tilts the blade to give a better angle of attack in tight corners. The blade can be folded 180 degrees into the handle and locked when not in use, permitting it to be kept in a tool box safely. The blade can be replaced when worn out and the entire tool is compact and durable as well as economical.



Part #	Qt
401-017	Ea

Safety Razor Scraper

- Features true push button action for blade positioning.
- Ideal for trimming, cutting and scraping.



Part #	Qt
401-040	Ea

Professional Model Scrapers

- Durable high-carbon precision ground steel blade.
- Black polypropylene handles are shatterproof and solvent resistant.
- Mirror finished and lacquered to prevent corrosion.



Part #	Item	Qt
401-075	1-1/4" Stiff Scraper/Putty Knife	Ea
401-085	3" Stiff Scraper/Putty Knife	Ea
401-080	2" Flex Scraper/Putty Knife	Ea

Knives

Outdoor Edge 3.5" Razor-Lite EDC

3.5" RAZORLITE EDC™ ORANGE

Includes six replacement blades.

Combines RazorSafe™ System Performance with everyday convenience.

The RazorLite EDC features a durable Grivory® frame handle with rubberized TPR inserts,

Stainless steel pocket clip.

SPECS Blade: 3.5 in / 7.6 or 8.9 cm

Overall: 8.0 in 20.3 cm

Weight: 2.0 or 2.8 oz / 57 or 80 g

Blade Steel: Japanese 420J2 stainless

Rockwell-C Hardness: 55-56 Holder:

420J2 with black-oxide coating

Handle: Grivory® with TPR inserts



Part #	ITEM	QT
401-560	3.5" Razor-Lite Orange	Ea

Set of 24 Japanese 420J2 stainless steel replacement razor-blades.

Each blade is precisely heat treated and hand finished to a surgically-sharp cutting edge.

These blades fit 3.5 inch models.



Part #	ITEM	QT
401-565	3.5" Razor-Lite Gray	Ea

Part #	ITEM	QT
401-580	3.5" Replacement Blades 24/pack	Ea

Knives

Outdoor Edge 3.0" Razor-Lite EDC

3.0" RAZORLITE EDC™ ORANGE
Includes six replacement blades.

Combines RazorSafe™ System
Performance with everyday convenience.

The RazorLite EDC features a durable
Grivory® frame handle with rubberized
TPR inserts,

Stainless steel pocket clip.

SPECS Blade: 3.0 or 3.5 in / 7.6 or 8.9
Overall: 8.0 in 20.3 cm

Weight: 2.0 or 2.8 oz / 57 or 80 g

Blade Steel: Japanese 420J2 stainless
Rockwell-C Hardness: 55-56 Holder: 420J2
with black-oxide coating

Handle: Grivory® with TPR inserts



Part #	ITEM	QT
401-570	3.0" Razor-Lite Orange	Ea

Set of 6 Japanese 420J2 stainless steel
replacement razor-blades.
Each blade is precisely heat treated and hand
finished to a surgically-sharp cutting edge.
These blades fit 3.0 inch models.



Part #	ITEM	QT
401-585	3.0" Replacement Blades 6/pack	Ea



Part #	ITEM	QT
401-575	3.0" Razor-Lite Gray	Ea

Knives

Trail Blaze Fixed Blade Knife

This double-duty knife, inspired by our expertise in the outdoors, is a true everyday-carry blade for town or on the trail.

Features:

- Reliable lockback
- Nonslip grip
- Pocket clip
- One-hand opening dual thumb studs
- Easy to spot blaze- orange handles

Specs:

- Blade: 2.5 or 3.3 in / 6.4 or 8.4 cm
- Overall: 5.75 or 7.5 in / 14.6 or 19.0 cm
- Steel: 8Cr13MoV
- Handle: Glass/nylon polymer with TPR inserts
- Weight: 1.2 or 2.6 oz / 34 or 74 g



Part #	ITEM	QT
401-620	Utility Orange	Ea

Mini Grip Fixed Blade Knife

These fully-functional mini-knives are perfect for the pocket, key chain, or handbag.

Each knife features a 2.2 inch 8Cr13MoV stainless blade that is precisely heat treated and hand finished shaving-sharp for superior edge retention and performance.

The double sided thumb-stud allows easy, one hand blade deployment.

Rubberized TPR handle scales are mounted to sturdy stainless steel liners for unparalleled strength and a secure, nonslip grip even when wet.

Each knife includes a nylon lanyard.



Part #	ITEM	QT
401-640	Mini Blaze Orange	Ea



Part #	ITEM	QT
401-645	Mini Grip Black	Ea

Knives

Outdoor Edge B.O.A. Utility Knife

B.O.A.™ Box Opening Assistant

This folding utility knife is a massive upgrade to the classic box cutter—and much, much more. The perfect ergonomics along with extensive jimping on the stainless steel blade holder delivers power from your hand directly to the cutting edge.

Simply and safely replace blades with a flick of your finger using the safety-guarded thumb button.

Accepts all standard utility razor blades.

Constructed of 420J2 stainless steel with a sure-grip textured glass/nylon polymer handle with pocket clip.



Part #	ITEM	QT
401-720	Utility Orange	Ea

6" Folding Utility Knife

- RUGGED AND COMPACT - Solid, one piece steel blade retainer is durable and folds down to less than 4 inches in length.
- ULTRA FAST BLADE CHANGE - One step blade change mechanism
- is quick, easy and secure
- EASY ONE HANDED OPENING - Smooth precise one handed opening and closing.
- PRECISION LINER-LOCK - The machined liner-lock locks securely for safe and confident operation.
- EXTREMELY LIGHTWEIGHT - Weighing less than 3 ounces makes it easy to always have a razor sharp knife at hand.
- BUILT-IN BELT CLIP - Allows for easy carrying inside the waist band or pocket.



Part #	Qt
BBT54005	EA

Shop Supplies

Proffered Retractable Utility Knife

Proffered T54001 Retractable Utility Knife, 6"

Features:

- Pop up blade dispenser release button allows instant blade storage and change
- Hassle free and no tools required for quick blade change
- SK2 blade storage and dispenser holds up to 5 additional blades
- Thermoplastic rubber (TPR) grip offers thumb rest and comfortable use with less slippage



Part #	Qt
BBT54001	EA

- EXTRA THICK** - Thick No.12 pattern reduces breaking and lasts longer for extended heavy-duty uses.
- ULTRA SHARP CUTTING EDGE** - Precision double-honed cutting edge provides a long lasting ultra sharp razor blade.
- PROFESSIONAL GRADE** - Heavy-duty pattern provides extreme durability for all cutting and scraping needs.
- NOTCHED DESIGN** Fits all standard industrial razor blade tools.
- Each blade is individually safety wrapped.



Part #	Item	Qt
401-000	Straight Blades	100

- Dispenser contains 100 high grade, razor honed, S2 steel knife blades.
- Safety dispenser makes handling blades easier and safer.
- 2-notch blades fit all standard 2-notch bladed utility knives.



Part #	Item	Qt
401-007	Angle Blades	100

Shop Supplies

Tools

25' / 7.5M TAPE MEASURE

Features:

- Tape Hook (end tip) made of stainless steel-more durable.
- Inch on top-1/8" increments on bottom.
- 16" marks in bold & blocked for framing studs.
- Black diamond placed for drywall installers to locate stud centers.
- Hi-impact ABS housing with non slip TPR grip.
- Nylon coated blade with magnetic tip.
- Duel side printed.
- Metric on top and bottom.



Part #	Qt
BBT53001	EA

MATTE PROFERRED TIGER PAW ADJUSTABLE WRENCH W/ PADDED HANDLE, MATTE FINISH

Features:

- Head triangle for increased hardness - HRC 3 degrees
- - Jaw teeth protects the corners of the nut, while reducing slippage at the same time
- - The hole design reduces overall weight by 10%, eliminating physical stress
- - TPR anti-slip grip material ensures a comfortable grip



Part #	Item	Qt
BBT06002	6" Wrench	Ea
BBT06003	8" Wrench	Ea
BBT06004	10" Wrench	Ea
BBT06005	12" Wrench	Ea

CURVED JAW LOCKING PLIERS

Features:

- Constructed from high grade, chrome molybdenum steel, providing superior strength and durability
- Harden teeth for gripping power and longevity
- Curved jaw design allows for a variety of material applications and shapes
- Quick adjust and release
- Nickle plated for maximum corrosion resistance

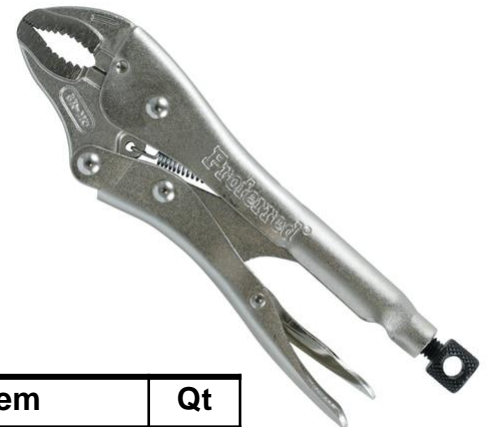

Part #	Item	Qt
BBT23007	7" Wrench	Ea
BBT23010	10" Wrench	Ea

Shop Supplies

Tools

LONG NOSE JAW LOCKING PLIERS

FEATURES:

- Constructed from high grade, chrome molybdenum steel, providing superior strength and durability
- Harden teeth for gripping power and longevity
- Curved jaw design allows for a variety of material applications and shapes
- Quick adjust and release
- Nickel plated for maximum corrosion resistance

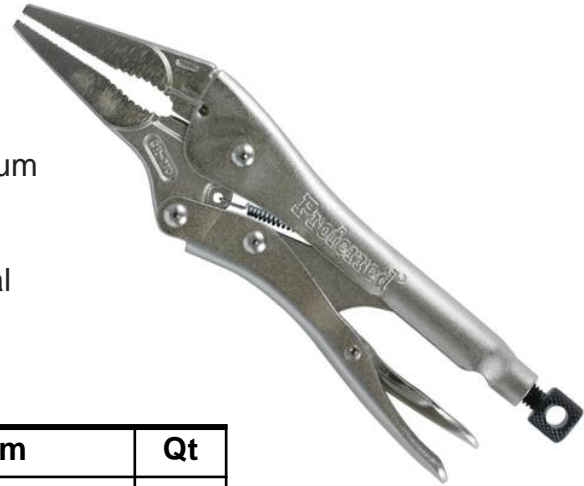

Part #	Item	Qt
BBT23409	9" Wrench	Ea

TPR SIDE CUTTING LONG NOSE PLIERS WITH CUTTER

FEATURES:

- TPR ergonomic and anti-fatigue comfort grips
- Meets heavy duty cutting and load test
- Hardened cutting edge cuts various types of wires
- Superior diamond teeth design for greater gripping ability

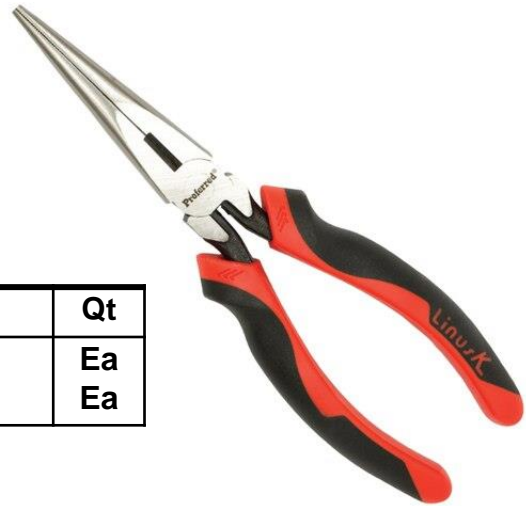

Part #	Item	Qt
BBT19001	6" Pliers	Ea
BBT19002	7" Pliers	Ea

TPR GRIP PROFERRED HIGH LEVERAGE HEAVY DUTY DIAGONAL PLIERS

FEATURES:

- Superior diamond teeth design for greater gripping ability
- Special high leverage design for increased cutting power
- Hardened cutting edge cuts various types of wires
- Ergonomic: Anti-fatigue comfort grip
- High leverage



Part #	Item	Qt
BBT15001	8-1/2" Pliers	Ea
BBT15002	9-1/2" Pliers	Ea

Shop Supplies

Tools

ANGLE ALL PURPOSE 7 IN 1 NOSE PLIERS

FEATURES:

- Angled head design allows for overall greater flexibility
- Diamond teeth design allows for greater gripping ability
- Easily strips 10-14 AWG solid and 12-16 AWG wire, crimps both 10-22 AWG terminals and connectors
- #6, #8 Bolt Cutter
- Induction-hardened cutting edges for hard & soft wire cutting
- TPR comfort grips
- Thumb-operated locking Mechanism on Grip handles for convenient use



Part #	Item	Qt
BBT20101	7" Pliers	Ea

TPR GRIP PROFERRED HIGH LEVERAGE HEAVY DUTY DIAGONAL CUTTERS

•FEATURES:

- Special high leverage design for increased cutting power
- Hardened cutting edge cuts various types of wires and extends cutting edge life cycle
- Ergonomic: Anti-fatigue comfort grip



Part #	Item	Qt
BBT17001	6" Cutter	Ea
BBT18002	7" Cutter	Ea
BBT18003	8" Cutter	Ea

PROFERRED FORGED HEAVY DUTY PIPE WRENCH

•FEATURES:

- Forged steel
- Handle material: cast iron
- Jaw material: drop forged carbon steel
- Long weighted handle for stability and leverage
- 14" can take a 2" diameter pipe
- 18" can take a 2-1/2" diameter pipe

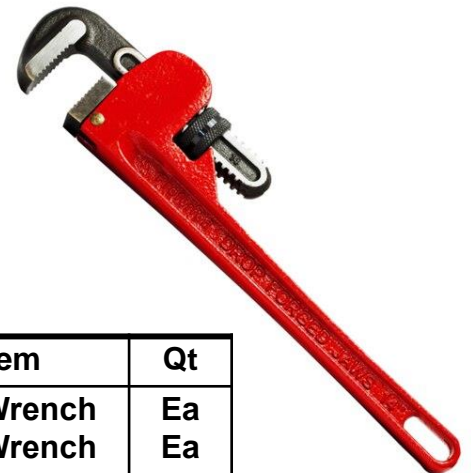

Part #	Item	Qt
BBT11014	14" Wrench	Ea
BBT11018	18" Wrench	Ea

Shop Supplies

Tools

COATED GRIP PREFERRED STRAIGHT JAW GROOVE JOINT PLIERS

•FEATURES:

- Wide range of jaw adjustments and machined jaw grooves
- Lay-on slip-joint
- Non-slip cushion grips

Part #	Item	Qt
BBT16001	8" Pliers	Ea
BBT16002	10" Pliers	Ea
BBT16003	12" Pliers	Ea
BBT16004	16" Pliers	Ea
BBT16005	20" Pliers	Ea

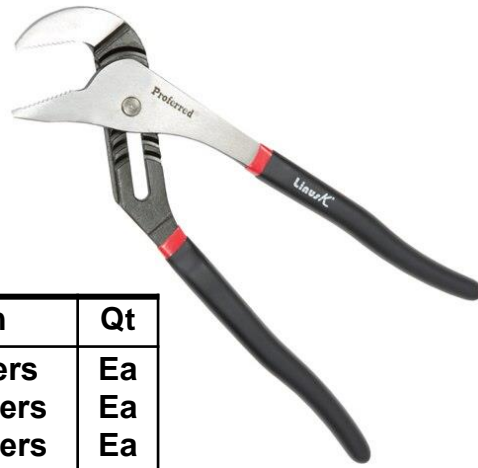

4-PIECE INSULATED SCREWDRIVER SETS

INCLUDES: (2) SLOTTED 1/4"X6", 5/16"X7", (2) PHILLIPS #1X3-3/16", #2X4"

FEATURES:

- Patented dual layer design provides greater protection against electric shock
- Dual material PP & TPV cushion grip provides slip resistance to chemical, oil, and most solvents

Part #	Item	Qt
BBT28004	4-pc Set	Ea



6-PIECE CUSHIONED SCREWDRIVER SETS

INCLUDES: (4) SLOTTED 3/16"X3", 3/16"X6", 1/4"X4", 5/16"X6"

FEATURES:

- Cellulose acetate material provides highest performance
- TPV cushion handle provides slip resistance to chemicals and most oils
- Treated blade tip ensures perfect fit
- Color coded handle for visual identification of Slotted and Phillips drives
- Blue handle for Phillips tips / Red handle for Slotted tips

Part #	Item	Qt
BBT28001	6-pc Set	Ea



Shop Supplies

Tools

ERGONOMIC STANDARD SCREWDRIVER WITH GO-THRU DESIGN

FEATURES:

- Go-thru designed screwdriver can absorb vibration produced during impact
- Hexagonal shape Shank can withstand higher impact force
- Dual material PP & TPV cushion grip provides slip resistance to chemical, oil and most solvents
- Color coded handle for visual identification, Slotted Red and Phillips Blue
- **Metal Driver all the way thru the handle**

Part #	Item	Color	Qt
BBT26012	#2 x 4" Phillip	Blue	Ea
BBT26013	#2 x 6" Phillip	Blue	Ea
BBT26014	#3 x 6" Phillip	Blue	Ea
BBT26015	#3 x 8" Phillip	Blue	Ea
BBT26002	1/4 x 4" Slot	Red	Ea
BBT26003	1/4 x 6" Slot	Red	Ea
BBT26004	5/16 x 6" Slot	Red	Ea
BBT26005	5/16 x 8" Slot	Red	Ea



FLEX RATCHETING COMBINATION WRENCH, CHROME FINISH

FEATURES:

- Torque capability is 30% greater than ANSI industrial standards
- 72-teeth, ratcheting box end needs only 5 degree swing arc versus 30 degree for standard box end wrenches
- Flex head tilts up to 180 degrees
- Quality chrome vanadium steel and heat treated for maximum strength

Part #	Item	Qt
BBT44008	1/4"	Ea
BBT44010	5/16"	Ea
BBT44012	3/8"	Ea
BBT44014	7/16"	Ea
BBT44016	1/2"	Ea
BBT44018	9/16"	Ea
BBT44020	5/8"	Ea
BBT44022	11/16"	Ea
BBT44024	3/4"	Ea

Part #	Item	Qt
BBT44100	8 mm	Ea
BBT44101	9 mm	Ea
BBT44102	10 mm	Ea
BBT44103	11 mm	Ea
BBT44104	12 mm	Ea
BBT44105	13 mm	Ea
BBT44106	14 mm	Ea
BBT44107	15 mm	Ea
BBT44108	16 mm	Ea
BBT44109	17 mm	Ea
BBT44110	18 mm	Ea
BBT44111	19 mm	Ea

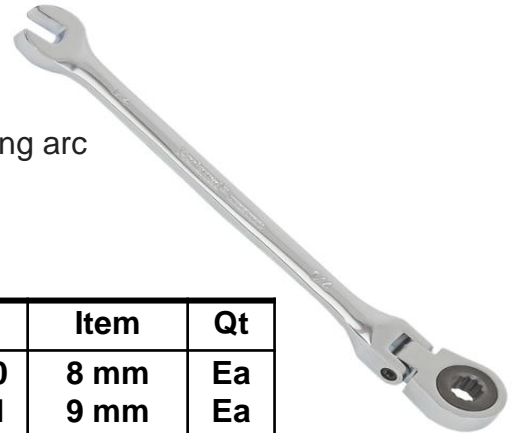

Shop Supplies

Tools

RATCHET CHROME FINISH

FEATURES:

- Fully polished chrome steel
- 72 Teeth
- Torque exceeds ANSI standard by 30%
- Forged for maximum strength

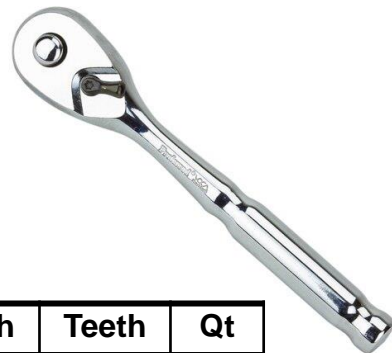

Part #	Drive	Length	Teeth	Qt
BBS40001	1/4	4-1/2"	72	Ea
BBS40101	3/8	8"	72	Ea
BBS40201	1/2	10"	80	Ea

BREAKER BAR CHROME FINISH

FEATURES:

- Fully polished chrome steel
- Forged for maximum strength

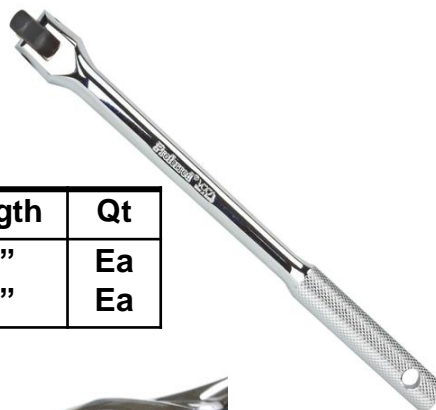

Part #	Drive	Length	Qt
BBS41101	3/8	10"	Ea
BBS41201	1/2	15"	Ea

COBRA FLEX BREAKER BAR CHROME FINISH

FEATURES:

- Fully polished chrome steel
- Forged for maximum strength
- Professional Strength



Part #	Drive	Length	Qt
BBS42101	3/8	8"	Ea
BBS42201	1/2	10"	Ea



UNIVERSAL JOINT CHROME FINISH

FEATURES:

- Fully polished chrome steel
- Forged for maximum strength
- Professional Strength

Part #	Drive	Qt	Impact #
BBS45001	1/4	Ea	
BBS45101	3/8	Ea	BBS46101
BBS45201	1/2	Ea	BBS46201

Shop Supplies

Tools

UNIVERSAL JOINT IMPACT

FEATURES:

- Forged for maximum strength
- Rust resistant phosphate finish
- Professional Quality

Part #	Drive	Qt
BBS46101	3/8	Ea
BBS46201	1/2	Ea



SOCKET DRIVE ADAPTER

- Forged for maximum strength
- Chrome finish
- Professional quality

Part #	Female	Male	Qt
BBS47101	3/8	1/4	Ea
BBS47102	3/8	1/2	Ea
BBS47201	1/2	3/8	Ea
BBS47202	1/2	3/4	Ea



SOCKET DRIVE EXTENTION BAR

- Forged for maximum strength
- Chrome finish
- Professional quality

Part #	Drive	Length	Qt
BBS43001	1/4	2"	Ea
BBS43002	1/4	4"	Ea
BBS43003	1/4	6"	Ea
BBS43101	3/8	3"	Ea
BBS43102	3/8	6"	Ea
BBS43103	3/8	10"	Ea
BBS43201	1/2	5"	Ea
BBS43202	1/2	10"	Ea
BBS43203	1/2	20"	Ea



IMPACT SOCKET DRIVE EXTENTION BAR

- Forged for maximum strength
- Rust resistant phosphate finish
- Professional Quality

Part #	Drive	Length	Qt
BBS44101	3/8	3"	Ea
BBS44102	3/8	6"	Ea
BBS44201	1/2	5"	Ea
BBS44202	1/2	10"	Ea



Shop Supplies

ROSIN CORE SOLDER: Used for electrical work because the residues which remain after soldering are non-corrosive and non-conductive. This prevents damage to delicate wires.

ACID CORE SOLDER: Used for general purpose work because of its chemical action. It will cut thru heavy tarnish and oxidation. **Not for electrical work** due to the residues that remain after soldering.

SOLID WIRE: Used on big jobs where more solder is required. When using solid wire it is always necessary to also use flux.

LEAD FREE SOLDER: Used on copper plumbing or hot water tanks, refrigeration systems or applications that require high strength. Each type of solder has a lead-free product.

SILVER SOLDER: Used for high strength repairs, and to join all metals except aluminum, magnesium and pot-metal. Ideal for stainless steel.

Pocket Solder

Rosin Core Solder used for electronic soldering
16g each and 1.0mm diameter

Melting point of soldering iron wire is 185°C - 190°C
(365°F - 374°F)

Tin Lead 60/40 Solder Wire for excellent electronic
assembly

Easy to carry plastic tubes protect solder from
moisture



Part #	Diam	Item	Qt
411-006	1.0	Tube	Ea

Shop Supplies

Solder Alloy Classification	Composite Tin	Lead	Temperature Melting Point	Uses
30/70	30	70	491	Economical alternative where a torch or sufficient heat are not used
40/60	40	60	460	This is the most popular general purpose available in acid and rosin flux core.
50/50	50	50	421	For plumbing, craft and general purpose soldering.
60/40	60	40	374	Used in electronic and electrical soldering applications where low soldering temperatures are required
63/37	63	37	361	Lowest melting solder for electronic applications
95/5	95	5	452	With higher electrical conductivity and high fluidity, 95/5 is recommended for lead free installation of small diameter, tight fitting connections Lead-free solder for Copper & Brass. 452- 464°F

- Tin Lead Solder Wire: High Quality Rosin Core Solder Wire
- Parameters: solder wire Tin 63%- Lead 37% (Sn63-Pb37)
- Flux content 1.8%,
- Electrical soldering wire dia is 0.8mm (0.0235inch), good size for pocket
- Low Melting Point: 361F/183C. easy to be soldered, flows smoothly, soldering fast and strong soldering point.
- Applications: Great soldering capability, especially for circuit board,
- DIY, home improvement,
- Repair of cable/TV/Radio/stereo/ Toys and other electrical devices etc.

63/37 Solder Rosin-Core

Part #	Item	Qt
411-010	0.8 mm	RL



Shop Supplies

Rosin Core:

60/40 60% tin, 40% lead solder with energizing-rosin core.
 Flux residue is completely non-corrosive and electrically non-conductive.
 Instant wetting action.
 374 F melting point.

Part #	Item	Qt
411-012	.032	RL
411-014	.050	RL
411-016	.093	RL



Acid Core:

40/60 40-percent Tin, and, 60-percent lead
 •Acid Core
 •Ideal for a range of Radiator/Tin/Metal work

Part #	Item	Qt
411-024	Acid Core 40/60 .125 1lb	Ea



95/5 Lead Free Plumbing Wire Solder is a tin-antimony wire solder designed for use in plumbing applications where frequent and extreme temperature changes and vibrations occur. It is NSF listed for potable water applications and common applications also include refrigeration lines and cooling equipment.

Part #	Item	Qt
411-018	95/5 Solder .125 1 lb	Ea



Shop Supplies

Paste Flux:

- The ideal flux for electrical and electronic repairs
- Contains 2 ounce in a "Hockey puck" Jar
- Formulated for use with tin/lead and lead-free alloys
- Dimensions: 2.5" Dia x 1" H (64 x 25.5 mm)
- Does not need to be cleaned
- Active temperature range: 93 – 315°c/ 200 – 600°
- Made in USA



Part #	Item	Qt
411-074	2 oz	Ea
411-076	4 oz	Ea

- Removes With: Flux Remover
- Size: 2 oz
- Item: Flux
- Color: Blue
- Material: Solder Flux

Part #	Item	Qt
411-079	2 oz	Ea



Features and Benefits:

- Available in a variety of gauges.
- Useful for temporary repairs, including those that require binding and tying
- Also suitable for a broad variety of household, industrial and commercial
- Conveniently available on a spool for ease of use.

Mechanics Wire

Part #	Item	Item	Qt
402-002	18 Gage	2 LB	Ea
402-004	16 Gage	2 LB	Ea



Shop Supplies

Torches / Fuel

Please Note: CAN NOT SHIP BUTANE FUEL

BLAZER BUTANE REFILL TRIPLE REFINED BUTANE

- Super Refined Gas – Winn Not Clog
- Each canister contains 324 mL of Super Refined Butane
- Cap Contains Adapters To Easily Refill Torches and Lighters
- 99.995 Refined

Part # 412-000



SELF-IGNITING MICRO BLASTER TORCH

- Includes a refillable gas lighter
- Produces flame temperatures up to 2400°F
- Hundreds of uses ranging from heat shrinking to soldering
- A must for every tool kit
- Self-igniting mechanism with a "lock-on" feature

Part # 412-006



SELF-IGNITING SUPER BLASTER TORCH

- Self-Igniting, Piezo Electronic Ignition System
- 2500°F/1300°C
- 120 minutes of continuous use
- Refillable
- Windproof flame
- Hand-held or table-top

Part # 412-010



SELF-IGNITING HEAVY-DUTY TORCH T-MTC-58

- Large flame, similar to propane torch
- Self-Igniting, Piezo Electronic Ignition System
- 2600°F/1350 °C
- 120 minutes of continuous use
- Refillable
- Windproof flame
- Hand-held or table-top

Part # 412-013



Shop Supplies

Torches

Please Note: CAN NOT SHIP PROPANE FUEL

Fuel			
Part #	Item	Size	Qt
412-015	Tall Propane Tank	14.2	Ea
412-016	Short Fat Propane Tank	16.4	Ea
412-017	Map Gas	14.1	Ea



Trig Start Adjustable Flame Torch Kit

- Kit includes: WK2301 Torch and 14.1 oz. propane cylinder
- Trigger-start ignition easily ignites the flame
- Use only with propane fuel
- Versatile webbed flame completes a variety of household projects, including small diameter soldering, thawing, melting and heat application
- Angled stainless steel burn tube
- Flame control valve easily sizes flame and extinguishes when finished
- Limited 3-year warranty



Part # 412-021

Shop Supplies

Torches

Please Note: CAN NOT SHIP PROPANE FUEL

Trig Start Professional Adjustable Flame Torch Kit

Precise flame adjustment with fine regulating valve, trigger start, standard torch for soft soldering and small heating jobs. High impact, fiber-reinforced body for safety and durability. High performance Piezo ignition (tested to 30,000 ignitions), ignites in damp conditions and a stable flame at all working angles. Includes: propane filled cylinder and torch.

- Kit includes: WK3401 Torch and 14.1 oz. propane cylinder
- Trigger-start ignition easily ignites the flame
- Use only with propane fuel
- Versatile webbed flame completes a variety of household projects, including small diameter soldering, thawing, melting and heat application
- Angled stainless steel burn tube
- Flame control valve easily sizes flame and extinguishes when finished
- Limited 3-year warranty



Part # 412-022

Trigger Start MAP/Pro Grade Propane Torch

Precise flame adjustment with fine regulating valve, trigger start, standard torch for soft soldering and small heating jobs. High impact, fiber-reinforced body for safety and durability. High performance Piezo ignition (tested to 30,000 ignitions), ignites in damp conditions and a stable flame at all working angles. Includes: Map Gas filled cylinder and torch.

- Kit includes: WT4601 Torch and 14.1 oz. map gas cylinder
- Trigger-start ignition easily ignites the flame
- Use only with map gas fuel
- Versatile webbed flame completes a variety of household projects, including small diameter soldering, thawing, melting and heat application
- Angled stainless steel burn tube
- Flame control valve easily sizes flame and extinguishes when finished
- Limited 3-year warranty



Part # 412-025

Shop Supplies

Heat Shrink Terminal Ratcheting Crimper

- DESIGNED FOR HEAT SHRINK TERMINALS - Each crimp station is rounded to create a professional crimp without cutting or damaging the terminal's heat shrink insulation.
- PERFORMS PERFECT CRIMPS - EVERY TIME - Ratcheting mechanism locks in place and assures a complete crimp cycle is achieved before the tool opens.
- USE ON HEAT SHRINK & PLAIN TERMINALS - Parallel oval jaws properly crimp heat-shrink, nylon and vinyl insulated terminals.
- CRIMPS UP TO 8 GAUGE TERMINALS - Eliminates the need for a second crimping tool with the addition of a fourth 8 gauge crimping nest. Crimps terminals from 22 gauge to 8 gauge using one tool.
- 4 COLOR-CODED CRIMP STATIONS - Each crimp station is labeled and color coded. Perform crimps on 22-18, 16-14, 12-10, & 8 gauge terminals.
- ERGONOMIC DESIGN - Comfortable, cushioned rubber grips reduce hand fatigue caused by repetitive use.
- MAKE PROFESSIONAL CRIMPS WITH EASE - High leverage design provides quick and easy crimping - even on tough-to-crimp 8 gauge connections. SELF-ALIGNING JAWS - Indexing tips prevent dies from sliding or rocking from side to side to ensure a secure and proper crimp. SAFETY RELEASE SWITCH - Built-in release lever allows the tool to be opened before completion of the crimp cycle if needed.



Ratchet Crimping Tool

Part #	Item	Qt
413-130	RATCHETING Crimping Tool	Ea

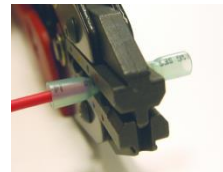
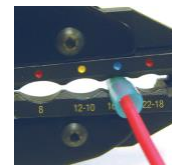

Release at any time

MULTI-PURPOSE HAND TOOL

- Crimping, cutting, stripping and rethreading tool
- Heat treated steel with padded vinyl handles
- Wire cutter is located at tip for easy access
- Wire stripper makes a complete cut of wire insulation with one stroke
- Cuts, crimps and strips 26 to 10 gauge wire and crimps ignition terminals
- Cuts and rethreads 4-40, 6-32, 8-32, 10-24 and 10-32 machine screws



Wire Stripper / Cutter / Crimper

Part #	Item	Qt
413-125	Crimper Tool	Ea

Shop Supplies

Hammer Crimp Tool

- Crimps up to 2/0 battery terminals and 8 gauge to 4/0 standard lugs plus non-insulated terminals.
- Takes the place of up to 3 different tools.
- One nest and one indenter eliminate changing tooling to crimp different terminals.
- Extremely compact - just 4" high, fits anywhere.
- Strike ram with a hammer for perfect connections.
- Crimping scale on side of tool makes crimping easy and prevents under-crimping.
- Nest design eliminates over-crimping.
- Ideal for truck garages, fleets, automotive service, off-road equipment, welding shops, in-plant maintenance.



Battery End Crimper

Part #	Item	Qt
413-070	Battery End Crimper	Ea

HEAVY DUTY CRIMPING TOOL (8 gauge to 1/0)

- Unique triangular crimp exerts equal pressure around the terminal, centers the cable and forms a solid mass of copper.
- Works on any battery terminal or lug.
- Crimps AWG or metric sizes.
- Crimps battery terminals, lugs and conventional stamped terminals of any thickness quickly and accurately.
- Toggle action head distributes equal force on all sides of the terminal to eliminate pinching and fracturing.
- Simple two finger die setting adjustments – no rotating dies, pins or springs to miss-align or set incorrectly.
- Compact design fits easily into tight fitting areas.
- Crimps from 8 gauge to 1/0



Part #	Qt
413-075	EA

HEAVY DUTY CRIMPING TOOL (6 gauge to 4/0)

- Unique triangular crimp exerts equal pressure around the terminal, centers the cable and forms a solid mass of copper.
- Works on any battery terminal or lug.
- Crimps AWG or metric sizes.
- Crimps battery terminals, lugs and conventional stamped terminals of any thickness quickly and accurately.
- Toggle action head distributes equal force on all sides of the terminal to eliminate pinching and fracturing.
- Simple two finger die setting adjustments – no rotating dies, pins or springs to miss-align or set incorrectly.
- Compact design fits easily into tight fitting areas.
- Crimps from 6 gauge to 4/0



Part #	Qt
413-080	EA

Shop Supplies

Hex Key Sets



Part #	Item	Mfg #	Qt
400-155	9 Piece SAE Allen Hex Key 5/64 – 1/4	25151	Ea
400-160	8 Piece METRIC Allen Hex Key 1.5mm – 8mm	25161	Ea
400-170	8 Piece Torx Hex Key T9, T10, T15, T20, T25, T27, T30, T40	25171	Ea



Part #	Item	Mfg #	Qt
400-172	11 Piece Combo Allen / Torx 5/64 – 1/4 / #15 & #20	2520	Ea
400-175	9 Piece SAE Allen Hex Key 5/64 – 1/4 BALL STYLE	25181	Ea
400-180	8 Piece METRIC Allen Hex Key 1.5mm – 8mm (ball Style)	25191	Ea

Shop Supplies



Shop Supplies

Vega Professional Hand Tools

- Made from S2 modified shock resistant steel for professional performance and durability.
- Dual composition ergonomic handle.
- Proprietary precision CNC machined tips for excellent fit in fastener recess.

PHILLIPS / SLOTTED SCREWDRIVER SET



Part #	Item	Qt
VEG R6PF	6 Piece Set	Ea



Tip Sizes: P0, P1, P2, P3, 1/4" 5/16"

TORX SCREWDRIVER SET



Part #	Item	Qt
VEG R06TX	6 Piece Set	Ea



Tip Sizes: 10, 15, 20, 25, 30, 40

TORX TAMPER SCREWDRIVER SET



Part #	Item	Qt
VEG R06TT	6 Piece Set	Ea



Tip Sizes: 10, 15, 20, 25, 30, 40

Shop Supplies

Vega Professional Hand Tools

- Made from S2 modified shock resistant steel for professional performance and durability.
- Dual composition ergonomic handle.
- Proprietary precision CNC machined tips for excellent fit in fastener recess.

6-in-1 Multi-Bit Screwdrivers



Professional Performance and Durability.

- Dual composition ergonomic handle.
- 6 drive options for maximum versatility.

Part #	Qt
VEG VCE6-1	Ea

4-in-1 Pocket Screwdrivers



- Professional Performance and Durability
- 4 drives in one compact pen design
- Caps have viewing window for quick choice of drive

Part #	Qt
VEG 4PSPP	Ea

Shop Supplies

Vega Professional Hand Tools

- Made from S2 modified shock resistant steel for professional performance and durability
- 2 Drive ends for versatility
- Proprietary precision CNC machined tips for excellent fit in fastener recess

Hex Long Key Set - Inch

Part Number	Tip Size
VEG HL10A VEG HBL 10A (ball drive)	1/16", 5/64", 3/32", 1/8", 5/32" 3/16", 7/32", 1/4", 5/16", 3/8"



Hex Long Key Set - Metric

Part Number	Tip Size
VEG HL10AM VEG HBL10AM (ball drive)	1.5mm, 2mm, 2.5mm, 3mm, 4mm, 5mm, 5.5mm, 6mm, 8mm, 10mm

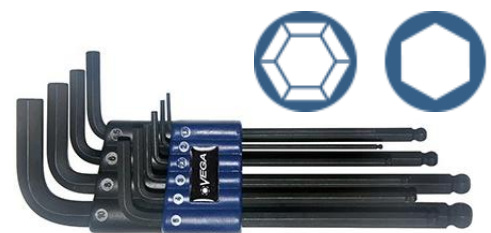

TORX Long Key Set

Part Number	Tip Size
VEG TL10A	8, 10, 15, 20, 25, 27, 30, 40, 45, 50



Shop Supplies

Vega Professional Hand Tools

- Made from S2 modified shock resistant steel for professional performance and durability.
- Contains hard to find and common bits for industry and construction
- Proprietary precision CNC machined tips for excellent fit in fastener recess.

100 PC Master Bit, Socket & Hand Driver Set

Contents:

- PHILLIPS: 0, 1, 2R, 2, 3, 4
 POZIDRIV: 0, 1, 2, 3, 4
 SQUARE: 0, 1, 2, 3, 4,5
 TORX: 6, 7, 8, 9, 10, 15, 20, 25, 27, 30, 40, 45, 50
 CLUTCH: 5/32, 3/16, 1/4
 HEX: 5/64, 3/32, 7/64, 1/8, 9/64, 5/32, 3/16, 7/32, 1/4, 5/16
 SLOTTED: 3-4, 4-5, 5-6, 6-8, 8-10, 10-12, 12-14
 PHILLIPS ACR II: 1, 2R, 2, 3
 POZIDRIV ACR 1, 2, 3
 TRIPPLE SQUARE: 4, 5, 6, 8
 TORQ-SET: 8, 10, 1/4, 5/16, 3/8
 SPANNER: 4, 6, 8, 10, 12
 TORX TAMPER: 6, 7, 8, 9, 10, 15, 20, 25, 27, 30, 40



Part #	Qt
VEG VHS100A	Ea

39 PC Socket & Hand Driver Set

Contents:

- PHILLIPS: 1, 2, 3
 TORX: 10, 15, 20, 25, 27, 30, 40
 PHILLIPS SQUARE-DRIV: 2-2
 SPANNER: 6, 8, 10
 SQUARE: 1, 2, 3
 SLOTTED: 3-4, 5-6, 6-8
 HEX: 5/64, 3/32, 7/64, 9/64, 3/16, 1/4
 1/4 sq dr Sockets: 3/16, 7/32, 1/4, 9/32, 5/16, 3/8, 7/16, 1/2, 9/16
 Quick Release Screwdriver(QMBS58)
 Y Adapter
 1/4" x 1/4" Socket Adapter (125ADB14)
 1/4" Square Drive Sliding T-Bar

Features:

- Strong metal storage case
- Contains standard and security insert bits, a quick release hand driver, and power tool and ratchet attachments



Part #	Qt
VEG V39	Ea

Shop Supplies

Vega Professional Hand Tools

- **Made from S2 modified shock resistant steel for professional performance and durability.**
- **Case includes convenient belt clip**
- **Proprietary precision CNC machined tips for excellent fit in fastener recess.**

32 PC Driver Bit Set

Contents:

PHILLIPS: 0, 1, 2, 2R, 3
 TORX: 10, 15, 20, 25, 27, 30, 40
 SLOTTED: 3-4, 4-5, 6-8, 8-10, 10-12
 HEX: 5/64, 3/32, 7/64, 1/8, 9/64, 5/32, 3/16,
 7/32, 1/4, 5/16
 SQUARE: 1, 2, 3
 SOCKET: 1/4" x 1/4"
 Quick Release Bit Holder



Part #	Qt
VEG V32-1P	Ea

32 PC Bit, Tamper Resistant Security Driver Bit Set

Contents:

PHILLIPS TAMPER: 2, 3
 TORX TAMPER: 5, 6, 7, 8, 9, 10, 15, 20, 25,
 27, 30, 40
 HEX TAMPER
 5/64, 3/32, 7/64, 1/8, 9/64, 5/32, 3/16,
 7/32, 1/4, 5/16
 SPANNER: 4, 6, 8, 10, 12, 14
 SOCKET: 1/4" x 1/4"
 Quick Release Bit Holder



Part #	Qt
VEG V32-1TP	Ea

Shop Supplies

Vega Professional Hand Tools

- Made from S2 modified shock resistant steel for professional performance and durability.
- Heavy duty drop resistant storage case
- Proprietary precision CNC machined tips for excellent fit in fastener recess.

33 PC Bit, Driver Bit Set

Contents:

PHILLIPS: 1, 2, 3

TORX: 10, 15, 20, 25, 30, 40

SLOTTED: 4-5, 5-6, 6-8, 8-10, 10-12

HEX: 5/64, 3/32, 1/8, 9/64, 5/32, 3/16

SQUARE: 1, 2, 3

ADAPTER: 1/4" x 1/4"

1/4" DR SOCKETS: 3/16, 7/32, 1/4, 9/32,

5/16, 3/8, 7/16, 1/2

Quick Release Insert Bit Holder



Part #	Qt
VEG V33-1SB	Ea

50 PC Industrial Driver Bit Set

Contents:

PHILLIPS: 0, 1, 2, 3

PHILLIPS: 0, 1, 2, 3 (ACR)

POZIDRIV: 0, 1, 2, 3

TORX: 5, 6, 7, 8, 9, 10, 15, 20, 25, 27, 30, 40

SLOTTED: 3-4, 4-5, 5-6, 6-8, 8-10, 10-12,
12-14, 14-16

HEX: 1/16, 5/64, 3/32, 7/64, 1/8, 9/64, 5/32,

3/16, 7/32, 1/4, 5/16

SQUARE: 0, 1, 2, 3

ADAPTER: 1/4" x 1/4"

SOCKET: 1/4" x 1/4"

Quick Release Bit Holder



Part #	Qt
VEG V50-1P	Ea

Shop Supplies

Vega Professional Hand Tools

- Made from S2 modified shock resistant steel for professional performance and durability.
- Includes industrial grade ratcheting bit wrench
- Proprietary precision CNC machined tips for excellent fit in fastener recess.

31 PC Industrial Driver Bit & Socket Set

Contents:

PHILLIPS: 1, 2, 3

SQUARE: 1, 2, 3

HEX: 9/64, 5/32, 3/16, 7/32, 1/4, 5/16

TORX: 8, 10, 15, 20, 25, 27, 30, 40

SLOTTED: 4-5, 6-8, 8-10

ADAPTER: 1/4" x 1/4"

Quick Release Magnet Bit Holder

SOCKETS: 1.4 square drive 1/4, 5/16, 3/8, 7/16, 1/2



Part #	Qt
VEG VSM31	Ea

31 PC Industrial Security Driver Bit & Socket Set

Contents:

PHILLIPS TAMPER: 1, 2, 3

TORX TAMPER: 8, 10, 15, 20, 25, 27, 30, 40

HEX TAMPER: 9/64, 5/32, 3/16, 7/32, 1/4, 5/16

SPANNER: 6, 8, 10

TRIPLE SQUARE: 4, 5, 6

Quick Release Bit Holder

SOCKETS: 1/4, 5/16, 3/8, 7/16, 1/2, 1/4" Female Hex

Magnet Bit Ratchet VEGA VSMT31 31pc Driver Bit Set



Part #	Qt
VEG VSMT31	Ea

Shop Supplies

Vega Professional Hand Tools

- Made from S2 modified shock resistant steel for professional performance and durability.
- Patented spiral torsion zone absorbs impact and extends bit life
- Tested to outperform all leading brands in lifecycle and tip failure testing
- Proprietary precision CNC machined tips for excellent fit in fastener recess.

21 PC Industrial Impact Driver Bit Set



Includes:

- Phillips #1, #2, #3 x 1"
- Square #1, #2, #3 x 1"
- TORX 20, 25, 27, 30 x 1"
- Phillips #1, #2 x 2"
- Square #1, #2 x 2"
- Phillips #2 x 6"
- Square #2 x 6"
- Mag Bit Holder, 3" 1/4", 5/16", 3/8", 7/16"
- Mag Nutsetter 3"

Part #	Qt
VEG P21-1DB	Ea

Shop Supplies

Vega Professional Hand Tools



1/4" Bit Ratchet

Part #	Item	Qt
VEG BR90	3-1/2" Long	Ea
VEG BR150	6" Long	Ea



1/4" Hex Bit Ratchet Compact

Part #	Item	Qt
VEG SBR90	3-1/2" Long	Ea



Quick Release Screwdriver

Part #	Item	Qt
VEG QMBS58	3-1/4" long	Ea



Magnetic Hex Drivers 1-3/4" Long

Part #	Item	Qt
VEG 145MN416	1/4	Ea
VEG 145MN516	5/16	Ea
VEG 145MN616	3/8	Ea
VEG 145MN716	7/16	Ea
VEG 145MN816	1/2	Ea
VEG 145MN916	9/16	Ea



Impact Magnetic Hex Drivers 2-9/16"

Impact #	Item	Qt
VEG P165MN416	1/4	Ea
VEG P165MN516	5/16	Ea
VEG P165MN616	3/8	Ea
VEG P165MN716	7/16	Ea
VEG P165MN816	1/2	Ea

Male Adapter and Extensions (ball type design)

Part #	Impact #	Item	Qt
VEG 150ADB14		1/4 x 2	Ea
VEG 150ADB38		3/8 x 2	Ea
VEG 150ADB12		1/2 x 2	Ea
	VEG 175QADB14	1/4 x 3	Ea
VEG 125ADB14	VEG P175QADB38	3/8 x 3	Ea
		1/4 x 1	Ea

Shop Supplies



AVERAGE DEGREE OF ROTATION AT TIP FAILURE
 Tested to outperform all leading brands
 in life cycle and tip failure testing



The more a bit flexes during rotation, the more it absorbs impact



- Quick Change
- Groove



- Tips Are CNC Machined



- Designed For Impact Use



Shop Supplies



Phillips Driver Bits 2" Length

Impact	Tip	Qt
VEG P150P1A	1	Ea
VEG P150P2A	2	Ea
VEG P150P3A	3	Ea



Male Adapter and Extensions (ball type design)

Impact Part #	Item	Qt
VEG P175QADB38	3/8 x 3	Ea

Phillips Driver Bits 2-3/4" Length

Impact	Tip	Qt
VEG P170P1A	1	Ea
VEG P170P2A	2	Ea
VEG P170P3A	3	Ea



Impact Magnetic Hex Drivers 2-9/16"

Impact #	Item	Qt
VEG P165MN416	1/4	Ea
VEG P165MN516	5/16	Ea
VEG P165MN616	3/8	Ea
VEG P165MN716	7/16	Ea
VEG P165MN816	1/2	Ea

Phillips Driver Bits 3-1/2" Length

Impact	Tip	Qt
VEG P190P1A	1	Ea
VEG P190P2A	2	Ea
VEG P190P3A	3	Ea

Phillips Driver Bits 6" Length

Impact	Tip	Qt
VEG P1150P1A	1	Ea
VEG P1150P2A	2	Ea
VEG P1150P3A	3	Ea

Shop Supplies

Power Drivers



Quick Release Magnetic Hex Drivers 2-3/8" Long

Part #	Item	Qt
VEG 160MH1QD	1/4	Ea



Impact Magnetic Bit Holder 3" Long

Part #	Item	Qt
VEG P175MH1QD2	1/4	Ea



1/4" Square Drive Impact Extension

Part #	Item	Qt
VEG 11EB1	1/4 X 1-3/8	Ea
VEG 11EB2	1/4 X 2"	Ea
VEG 11EB3	1/4 X 3"	Ea



Magnetic Bit Holders

Part #	Item	Qt
VEG 175MH1CD	1/4 X 3"	Ea
VEG 1150MH1CD2	1/4 X 6"	Ea

1/4" Square Drive Impact Extension(PIN)

Part #	Item	Qt
VEG 11EP1	1/4 X 1"	Ea



Impact Magnetic Bit Holders

Part #	Item	Qt
VEG P175MH1QD2	1/4 X 3"	Ea
VEG P1150MH1CD2	1/4 X 6"	Ea

3/8" Drive Impact Socket Extension Drivers

Power	Item	Qt
VEG 22EB1	3/8 X 1-3/8	Ea
VEG 22EB2	3/8 X 2"	Ea
VEG 22EB3	3/8 X 3"	Ea



1-1/4" Long Impact Insert Bits

Part #	Item	Qt
VEG 230P2F	#2	Ea
VEG 230P3F	#3	Ea

1/2" Drive Impact Socket Extension Drivers

Part #	Item	Qt
VEG 33EB1	1/2 X 1-3/8	Ea
VEG 33EB2	1/2 X 2"	Ea
VEG 33EB3	1/2 X 3"	Ea



Square Drive Quick Release Magnetic Bit Holders

Part #	Item	Qt
VEG M1HC416SK2	1/4 X 1/4	Ea
VEG M2HC416SK2	1/4 X 3/8	Ea



Square Drive Quick Release Magnetic Bit Holders

Part #	Item	Qt
VEG 1HQ416SK	1/4 X 1/4	Ea
VEG 1HS416SK	1/4 X 1/4	Ea
VEG 3HQ416SK	1/4 X 1/2	Ea

Shop Supplies

Power Drivers 1/4" Shank



PHILLIPS

Phillips Insert Driver Bits 1" Length

Power	Impact	Tip	Qt
VEG 125P0A		0	Ea
VEG 125P1A	VEG P125P1A	1	Ea
VEG 125P2A	VEG P125P2A	2	Ea
VEG 125P3A	VEG P125P3A	3	Ea



SQUARE

Square Insert Driver Bits 1" Length

Power	Impact	Tip	Qt
VEG 125R1A	VEG P125R1A	#1	Ea
VEG 125R2A	VEG P125R2A	#2	Ea
VEG 125R3A	VEG P125R3A	#3	Ea



PHILLIPS

Phillips Power Driver Bits 2" Length

Power	Impact	Tip	Qt
VEG 150P1A	VEG P150P1A	1	Ea
VEG 150P2A	VEG P150P2A	2	Ea
VEG 150P3A	VEG P150P3A	3	Ea



SQUARE

Square Power Driver Bits 2" Length

Power	Impact	Tip	Qt
VEG 150R1A	VEG P150R1A	1	Ea
VEG 150R2A	VEG P150R2A	2	Ea
VEG 150R3A	VEG P150R3A	3	Ea



Phillips Power Driver Bits 2-3/4" Length

PHILLIPS

Power	Impact	Tip	Qt
VEG 170P1A	VEG P170P1A	1	Ea
VEG 170P2A	VEG P170P2A	2	Ea
VEG 170P3A	VEG P170P3A	3	Ea



SQUARE

Square Power Driver Bits 2-3/4" Length

Power	Impact	Tip	Qt
VEG 170R1A	VEG P170R1A	1	Ea
VEG 170R2A	VEG P170R2A	2	Ea
VEG 170R3A	VEG P170R3A	3	Ea



Phillips Power Driver Bits 3-1/2" Length

PHILLIPS

Power	Impact	Tip	Qt
VEG 190P1A	VEG P190P1A	1	Ea
VEG 190P2A	VEG P190P2A	2	Ea
VEG 190P3A	VEG P190P3A	3	Ea



SQUARE

Square Power Driver Bits 3-1/2" Length

Power	Impact	Tip	Qt
VEG 190R1A	VEG P190R1A	1	Ea
VEG 190R2A	VEG P190R2A	2	Ea
VEG 190R3A	VEG P190R3A	3	Ea



Phillips Power Driver Bits 6" Length

PHILLIPS

Power	Impact	Tip	Qt
VEG 1150P1A	VEG P1150P1A	1	Ea
VEG 1150P2A	VEG P1150P2A	2	Ea
VEG 1150P3A	VEG P1150P3A	3	Ea



SQUARE

Square Power Driver Bits 6" Length

Power	Impact	Tip	Qt
VEG 1150R1A	VEG P1150R1A	1	Ea
VEG 1150R2A	VEG P1150R2A	2	Ea
VEG 1150R3A	VEG P1150R3A	3	Ea

Shop Supplies

Power Drivers 1/4" Shank



TORX Insert Driver Bits 1" Length



TORX Power Driver Bits 3-1/2" Length

Power	Impact	Tip	Qt
VEG 125T07A		7	Ea
VEG 125T08A		8	Ea
VEG 125T09A		9	Ea
VEG 125T10A	VEG P125T10A	10	Ea
VEG 125T15A	VEG P125T15A	15	Ea
VEG 125T20A	VEG P125T20A	20	Ea
VEG 125T25A	VEG P125T25A	25	Ea
VEG 125T27A	VEG P125T27A	27	Ea
VEG 125T30A	VEG P125T30A	30	Ea
VEG 125T40A	VEG P125T40A	40	Ea
VEG 125T45A		45	Ea
VEG 125T50A		50	Ea

Power	Impact	Tip	Qt
VEG 190T07A		7	Ea
VEG 190T08A		8	Ea
VEG 190T09A		9	Ea
VEG 190T10A		10	Ea
VEG 190T15A		15	Ea
VEG 190T20A		20	Ea
VEG 190T25A		25	Ea
VEG 190T27A		27	Ea
VEG 190T30A		30	Ea
VEG 190T40A		40	Ea



TORX Power Driver Bits 2" Length



TORX Power Driver Bits 6" Length

Power	Impact	Tip	Qt
VEG 150T07A		7	Ea
VEG 150T08A		8	Ea
VEG 150T09A		9	Ea
VEG 150T10A	VEG P150T10A	10	Ea
VEG 150T15A	VEG P150T15A	15	Ea
VEG 150T20A	VEG P150T20A	20	Ea
VEG 150T25A	VEG P150T25A	25	Ea
VEG 150T27A	VEG P150T27A	27	Ea
VEG 150T30A	VEG P150T30A	30	Ea
VEG 150T40A	VEG P150T40A	40	Ea
VEG 150T45A		45	Ea
VEG 150T50A		50	Ea

Power	Impact	Tip	Qt
VEG 1150T07A		7	Ea
VEG 1150T08A		8	Ea
VEG 1150T09A		9	Ea
VEG 1150T10A		10	Ea
VEG 1150T15A		15	Ea
VEG 1150T20A		20	Ea
VEG 1150T25A		25	Ea
VEG 1150T27A		27	Ea
VEG 1150T30A		30	Ea
VEG 1150T40A		40	Ea

Shop Supplies

Power Drivers 1/4" Shank



HEX



Hex Insert Driver Bits 1" Length

Power	Impact	Tip	Qt
VEG 125H0464A		1/16	Ea
VEG 125H0564A		5/64	Ea
VEG 125H0664A		3/32	Ea
VEG 125H0764A		7/64	Ea
VEG 125H0864A		1/8	Ea
VEG 125H0964A		9/64	Ea
VEG 125H1064A	VEG P125H1064A	5/32	Ea
VEG 125H1264A	VEG P125H1264A	3/16	Ea
VEG 125H1464A	VEG P125H1464A	7/32	Ea
VEG 125H1664A	VEG P125H1664A	1/4	Ea
VEG 125H2064A		5/16	Ea



HEX
TAMPER



Hex Tamper Resistant Insert Driver Bits 1" Length

Power	Impact	Tip	Qt
VEG 125HT0564A		5/64	Ea
VEG 125HT0664A		3/32	Ea
VEG 125HT0764A		7/64	Ea
VEG 125HT0864A		1/8	Ea
VEG 125HT0964A		9/64	Ea
VEG 125HT1064A		5/32	Ea
VEG 125HT1264A		3/16	Ea
VEG 125HT1464A		7/32	Ea
VEG 125HT1664A		1/4	Ea
VEG 125HT2064A		5/16	Ea

Shop Supplies

Power Drivers 1/4" Shank



Power	Impact	Tip	Qt
VEG 125H015A		1.5mm	Ea
VEG 125H020A		2mm	Ea
VEG 125H025A		2.5mm	Ea
VEG 125H030A	VEG P125H030A	3mm	Ea
VEG 125H040A	VEG P125H040A	4mm	Ea
VEG 125H050A	VEG P125H050A	5mm	Ea
VEG 125H060A	VEG P125H060A	6mm	Ea
VEG 125H070A		7mm	Ea
VEG 125H080A		8mm	Ea



Power	Impact	Tip	Qt
VEG 125F04A	VEG P125F04A	3-4	Ea
VEG 125F05A		4-5	Ea
VEG 125F06A	VEG P125F06A	5-6	Ea
VEG 125F08A	VEG P125F08A	6-8	Ea
VEG 125F10A		8-10	Ea
VEG 125F12A		10-12	Ea



Power	Impact	Tip	Qt
VEG 125SP04A		#4	Ea
VEG 125SP06A		#6	Ea
VEG 125SP08A		#8	Ea
VEG 125SP10A		#10	Ea
VEG 125SP12A		#12	Ea
VEG125SP14A		#14	Ea

Shop Supplies

Power Drivers 1/4" Shank



**TORX[®]
TAMPER**



**Tamper Resistant TORX
Insert Driver Bits 1" Length**

Power	Impact	Tip	Qt
VEG 125TT05A		5	Ea
VEG 125TT06A		6	Ea
VEG 125TT07A		7	Ea
VEG 125TT08A		8	Ea
VEG 125TT09A		9	Ea
VEG 125TT10A		10	Ea
VEG 125TT15A		15	Ea
VEG 125TT20A		20	Ea
VEG 125TT25A		25	Ea
VEG 125TT27A		27	Ea
VEG 125TT30A		30	Ea
VEG 125TT40A		40	Ea



**PHILLIPS
TAMPER**



**Tamper Resistant Phillip
Insert Driver Bits 1" Length**

Power	Impact	Tip	Qt
VEG 125TP1A		1	Ea
VEG 125TP2A		2	Ea
VEG 125TP3A		3	Ea



TORX[®]



**Torx Power Bits
7/16 Shank 2" Length**

Power	Impact	Tip	Qt
VEG 350T30A		30	Ea
VEG 350T40A		40	Ea
VEG 350T45A		45	Ea
VEG 350T50A		50	Ea
VEG 350T55A		55	Ea
VEG 350T60A		60	Ea
VEG 350T70A		70	Ea



**PHILLIPS
SQUARE-DRIV[®]**



Pozi-Drive Insert Driver Bits 2" Length

Power	Impact	Tip	Qt
VEG 150PSD12		#1	Ea
VEG 150PSD22		#2	Ea
VEG 150PSD33		#3	Ea



**TORX[®]
ALIGN**



**Torx Align Insert Bits
5/16 Shank 1-1/4" Length**

Power	Impact	Tip	Qt
VEG 230T30W		30	Ea
VEG 230T45W		45	Ea



POZIDRIV[®]



Pozi-Drive Insert Driver Bits 1" Length

Power	Impact	Tip	Qt
VEG 125Z1A		#1	Ea
VEG 125Z2A		#2	Ea
VEG 125Z3A		#3	Ea



PHILLIPS



**Phillips Socket Bits
3/8 Drive 2-5/8" Length**

Power	Impact	Tip	Qt
VEG 267P2SK		#2	Ea
VEG 267P3SK		#3	Ea

Cabinets and Bins

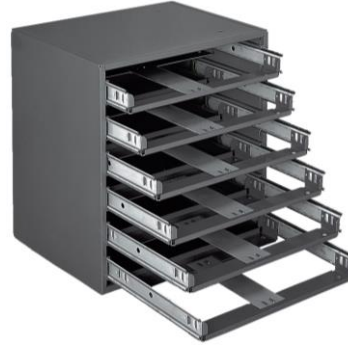

Heavy Duty Bearing Slide Rack, cold-rolled steel, 4 sliding compartments, positive closure feature to keep trays in, punched holes for installation, gray

Heavy Duty Bearing Slide Rack, cold-rolled steel, 6 sliding compartments, positive closure feature to keep trays in, punched holes for installation, gray

Part #	Durham #	Qt
990-004	303B-15.75-95	Ea

Part #	Durham #	Qt
990-002	321B-95	Ea

20-3/8 x 15-3/4 x 14-7/8
(drawer size 18" wide x 12" deep x 3" high)

20-5/16 x 15-15/16 x 21-7/8
(drawer size 18" wide x 12" deep x 3" high)



Base for models: 302B, 303B, 321B

Base for models: 302B, 303B, 321B

Part #	Durham #	Qt
990-005	304-95	Ea

Part #	Durham #	Qt
990-006	304-95-5.75	Ea

20-9/16 x 16-1/8 x 15" Legs

20-9/16 x 16-1/8 x 5-3/8" Legs



Large, steel, compartment box, 24 compartments, steel, gray

Large, steel, compartment box, adjustable compartments, steel, gray

Part #	Durham #	Qt
990-124	102-95	Ea

Part #	Durham #	Qt
990-134	119-95	Ea
990-135	120-95 dividers	9

18" wide x 12" deep x 3" high

18" wide x 12" deep x 3" high

Cabinets and Bins



Large, steel, compartment box,
32 compartments, steel, gray

Part #	Durham #	Qt
990-132	107-95	Ea

18" wide x 12" deep x 3" high



Large, steel, compartment box,
21 compartments, steel, gray

Part #	Durham #	Qt
990-121	109-95	Ea

18" wide x 12" deep x 3" high



Large steel 6 to 48 compartments:
1-27/32 x 17-1/2
Adjustable on 2-7/32 centers steel, gray

Part #	Durham #	Qt
990-106	099-95	Ea
990-104	097-95 dividers	12

18" wide x 12" deep x 3" high



Large, steel, compartment box,
20 compartments, steel, gray

Part #	Durham #	Qt
990-118	111-95	Ea

18" wide x 12" deep x 3" high



Large, steel, compartment box, 6
compartments, horizontal, steel, gray

Part #	Durham #	Qt
990-114	125-95	Ea

18" wide x 12" deep x 3" high



Large, steel, compartment box, 6
compartments, vertical, steel, gray

Part #	Durham #	Qt
990-116	117-95	Ea

18" wide x 12" deep x 3" high

Cabinets and Bins



6 drawer metal storage unit for small parts storage, steel, gray

Part #	Durham #	Qt
990-430	001-95	Ea

11-3/4 x 11-11/16 x 10-7/8



8 drawer metal storage unit for small parts storage, steel, gray

Part #	Durham #	Qt
990-035	303-95	Ea

22-13/16 x 11-11/16 x 7-3/8

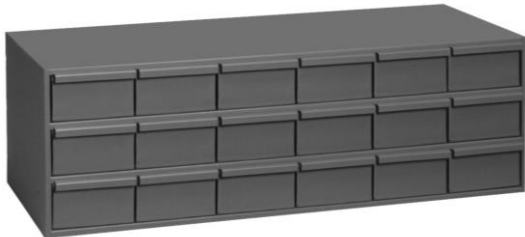

18 drawer metal storage unit for small parts storage, steel, gray

Part #	Durham #	Qt
990-437	005-95	Ea

33-13/16 x 11-11/16 x 10-13/16



Small, steel, compartment box, 24 compartments, steel, gray

Part #	Durham #	Qt
990-142	215-95	Ea

13-3/8" x 9-1/4" x 2"



Slide rack, small, easy glide, holds 6 small compartment boxes, gray

Part #	Durham #	Qt
990-007	308-95	Ea

15-1/4 x 11-3/4 x 16-3/8
(drawer size 13-3/8" x 9-1/4" x 2")



Small, steel, compartment box, adjustable compartments, steel, gray

Part #	Durham #	Qt
990-134	119-95	Ea

13-3/8" x 9-1/4" x 2"

Cabinets and Bins



40 opening bin, 12" deep steel, gray

Part #	Durham #	Qt
990-440	359-95	Ea

33-7/8" x 12" x 24"

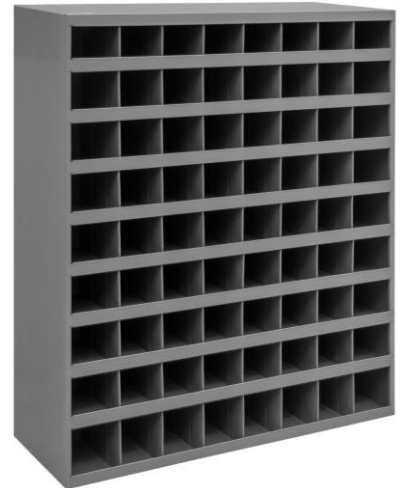

72 opening bin, 12" deep steel, gray

Part #	Durham #	Qt
990-445	363-95	Ea

33-7/8" x 12" x 42"

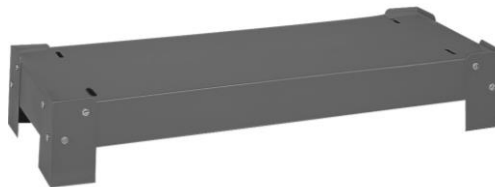

Fits 40 and 72 hole bin, steel, gray

Part #	Durham #	Qt
990-448	364-95	Ea

33-7/8" x 12-1/4" x 5-3/4" Legs

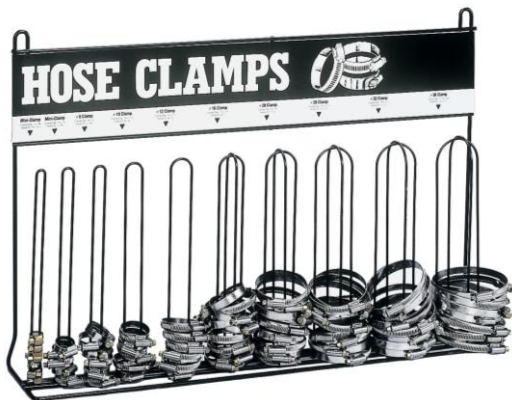

10 loop with out clamps

Part #	Durham #	Qt
990-134	907-08-S129	Ea

23-1/4 x 5-3/8 x 16-1/8

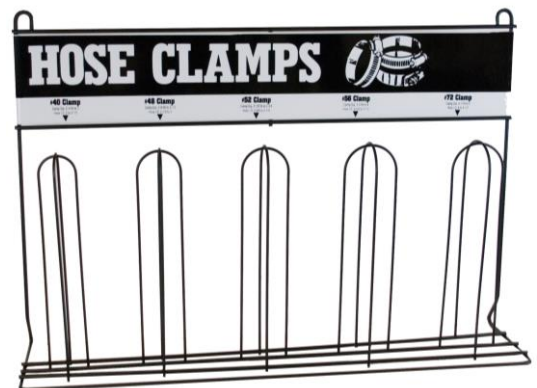

5 loop with out clamps

Part #	Durham #	Qt
990-134	905-08-S702	Ea

23-1/4 x 5-3/8 x 16-1/8

Cabinets and Bins

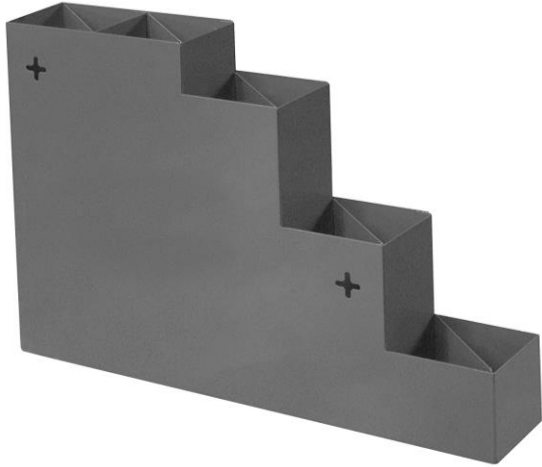

Empty Nylon Tie Cabinet

Part #	Durham #	Qt
990-162	298-95	Ea

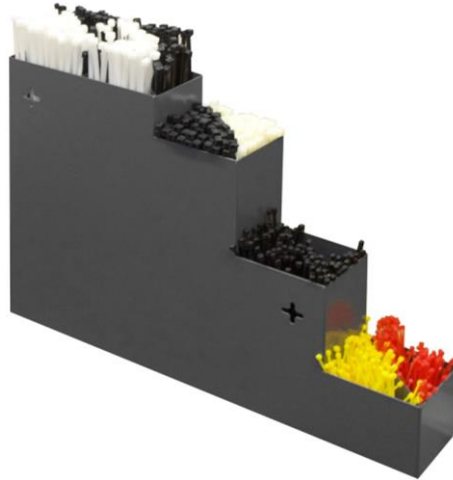

Nylon Tie Assortment

Part #	Qt
0439-75	Ea



**3" CUT-OFF WHEEL DISPENSER,
WALL MOUNTABLE, GRAY**

Part #	Durham #	Qt
990-170	555-95	Ea



**4" CUT-OFF WHEEL DISPENSER,
WALL MOUNTABLE, GRAY**

Part #	Durham #	Qt
990-175	556-95	Ea

**4-1/2" CUT-OFF WHEEL DISPENSER,
WALL MOUNTABLE, GRAY**

Part #	Durham #	Qt
990-180	557-95	Ea



Cabinets and Bins



Wire rack": 26-1/8 x 5-7/8 x 36-1/2

Part #	Durham #	Qt
990-738	368-95	Ea



Rod rack": 24-1/8 x 6-7/8 x 24

Part #	Durham #	Qt
990-750	367-95	Ea



Aerosol can caddy, steel, gray

Part #	Durham #	Qt
990-760	385-95	Ea



Small, plastic compartment box, 6 openings, clear

Part #	Durham #	Qt
990-206	Sp6-clear	Ea

10-13/16" wide x 6-3/4" deep x 1-3/4" high



Small, plastic compartment box, 12 openings, clear

Part #	Durham #	Qt
990-208	Sp12-clear	Ea

10-13/16" wide x 6-3/4" deep x 1-3/4" high



Small, plastic compartment box, 12 openings, clear

Part #	Durham #	Qt
990-210	Spos12-clear	Ea

10-13/16" wide x 6-3/4" deep x 1-3/4" high

Cabinets and Bins



Small, plastic compartment box, 13 openings, clear

Part #	Durham #	Qt
990-212	Sp13-clear	Ea

10-13/16" wide x 6-3/4" deep x 1-3/4" high



Small, plastic compartment box, 18 openings, clear

Part #	Durham #	Qt
990-214	Sp18-clear	Ea

10-13/16" wide x 6-3/4" deep x 1-3/4" high



Small, plastic compartment box, adj openings, clear

Part #	Durham #	Qt
990-216	Spadj-clear	Ea

10-13/16" wide x 6-3/4" deep x 1-3/4" high



Large, plastic compartment box, 6 openings, clear

Part #	Durham #	Qt
990-218	Lp6-clear	Ea

13-1/8" wide x 9" deep x 2-5/16" high



Large, plastic compartment box, 12 openings, clear

Part #	Durham #	Qt
990-220	Lp12-clear	Ea

13-1/8" wide x 9" deep x 2-5/16" high



Large, plastic compartment box, 16 openings, clear

Part #	Durham #	Qt
990-222	Lp16-clear	Ea

13-1/8" wide x 9" deep x 2-5/16" high

Cabinets and Bins



Large, plastic compartment box, 18 openings, clear

Part #	Durham #	Qt
990-224	Lp18-clear	Ea

13-1/8" wide x 9" deep x 2-5/16" high



Large, plastic compartment box, 24 openings, clear

Part #	Durham #	Qt
990-226	Lp24-clear	Ea

13-1/8" wide x 9" deep x 2-5/16" high



Large, plastic compartment box, adj openings, clear

Part #	Durham #	Qt
990-228	Lpadj-clear	Ea

13-1/8" wide x 9" deep x 2-5/16" high

