

# Assortments

**Columbus Fleet Industrial Supply**

**Canton Fleet Industrial Supply**

**Canton First Aid & Safety**



## 00150-25 (W5342) 106 Pc Allen Heads Assortment

• Sizes: 8-32 x 1/2 25 pcs, 10-24 x 1/2 25 pcs, 10-24 x 1 20 pcs, 1/4-20 x 1 10 pcs, 1/4-20 x 1/2 10 pcs, 5/16-18 x 1-1/2 5 pcs, 5/16 x 1 5 pcs, 3/8-16 x 1-1/2 3 pcs 3/8-16 x 1 3 pcs



## 00191-20 (W5206) 150 pc Cotter Pin Assortment

• Sizes: 1/8 by 2-Inch 50 pcs, 5/32 by 2 1/2-Inch 30 pcs, 3/16 by 3-Inch 20 pcs, 1/4 by 2-Inch 25 pcs, 1/4 by 3-Inch 15 pcs, 5/16 by 2 1/2-Inch 10 pcs



## 00191-5 (W5204) 1000 pc Cotter Pin Assortment

• Sizes: 1/16-Inch by 1-Inch 380 pcs, 3/32-Inch by 1-Inch 240 pcs, 3/32-Inch by 1 1/2-Inch 140 pcs  
• 1/8-Inch by 1 1/4-Inch 115 pcs, 1/8-Inch by 2-Inch 75 pcs, 5/32-Inch by 2-1/2-Inch 50 pcs



## 00192-5 (W5210) 150 Pc Hair Pin Assortment

• Sizes: 3/32 x 1-3/16, 5/64 x 1-5/16, 5/64 x 1-9/16, 7/64 x 1-5/8, 9/64 x 1-3/4, 5/32 x 2-15/16



## 00193-10 (W5359) 74 Pc Clevis Pin Assortment

Hair Pins sizes: 7/64 x 1-5/8 20 each, 5/64 x 1-5/16 8 each 7/64 x 2-5/16, 7 each 9/64 x 1-3/4 Clevis Pins Sizes 18 each 5/16 x 2-1/2 5 ea 7/16 x 2-1/2, 5 ea 3/8 x 2, 3 ea 1/2 x 2



## 00194-20 (W5340) 150 pc Split Pin Assortment

(4) 5/32" x 5/8" (4) 5/32" x 1" (4) 5/32" x 1-1/2" (4) 1/4" x 5/8" (4) 1/4" x 1-1/4" (4) 1/4" x 1-3/4" (4) 5/64" x 1/4" (4) 5/64" x 1/2" (4) 5/64" x 2" (4) 1/16" x 3/16" (4) 1/16" x 5/16" (4) 1/16" x 3/4" (4) 5/16" x 3/4" (4) 5/16" x 1-1/2" (4) 5/16" x 2" (2) 3/8" x 3/4" (2) 3/8" x 1-1/2" (2) 3/8" x 2" (4) 3/32" x 5/8" (4) 3/32" x 1" (4) 3/32" x 1-1/4" (4) 7/32" x 5/8" (4) 7/32" x 1-1/4" (4) 7/32" x 1-3/4" (5) 1/8" x 5/8" (5) 1/8" x 1" (5) 1/8" x 1-1/4" (5) 3/16" x 5/8" (5) 3/16" x 1" (5) 3/16" x 1-1/4"



## 00195-35 (W5343) 1000 pc Woodruff Keys

SIZES: (10) 1/8 x 3/16 x 33/64, (10) 1/8 x 1/4 x 41/64, (10) 5/32 x 3/16 x 33/64, (10) 5/32 x 1/4 x 41/64, (10) 5/32 x 19/64 x 49/64, (10) 3/16 x 23/64 x 7/8, (10) 1.4 x 2364 x 7/8, (10) 3/16 x 19/64 x 49/64

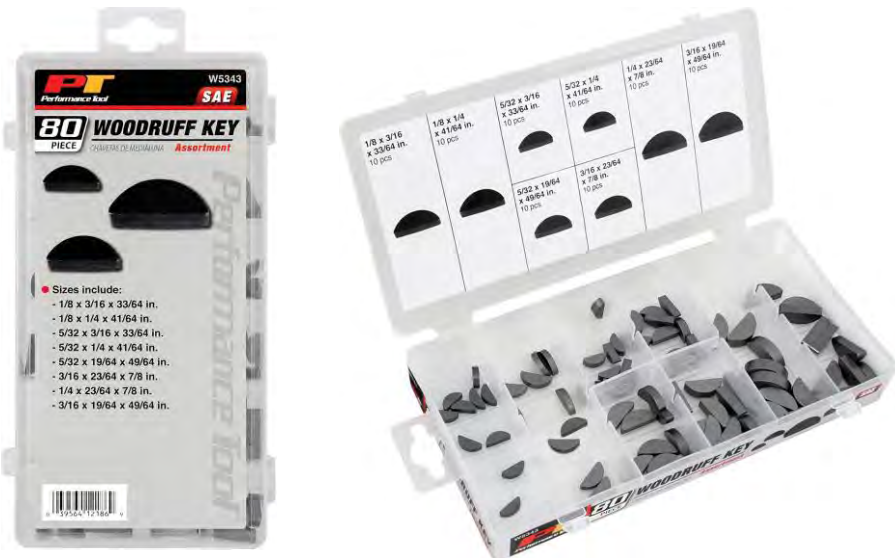

## 00195-40 (W5341) 1000 pc Metric Woodruff Keys

SIZES: (10) 3 x 5 x 13, (10) 3 x 6.5 x 16, (10) 4 x 5 x 13, (10) 4 x 6.5 x 16, (10) 4 x 7.5 x 19, (10) 5 x 9 x 22, (10) 6 x 9 x 22



### 00196-5 (W5208) 300 Pc E Ring Assortment

SIZES: (30) 1/16", (30) 1/8", (40) 3/16", (50) 1/4", (50) 3/8", (40) 1/2", (20) 5/8", (20) 3/4", (20) 7/8"



### 00197-5 (W5212) 300 pc Snap Ring Assortment

SIZES: (20) 1/8", (10) 5/32", (15) 3/16", (25) 1/4", (15) 5/16", (20) 3/8", (15) 7/16", (15) 15/32", (25) 1/2", (15) 9/16", (20) 5/8", (25) 3/4", (15) 13/16", (20) 7/8", (15) 1", (15) 1-1/16", (10) 1-1/8", (5) 1-1/4"



### 00198-20 (W5239) 180 pc Small Viton )-Ring Asst

- INCLUDES: 18 different sizes in a lightweight, convenient storage kit
- COMPATIBILITY: Works with biodiesel, and ethanol; high resistance to permeation and chemical attack by alcohol, pure ethanol, and blends of ethanol with hydrocarbon fuel

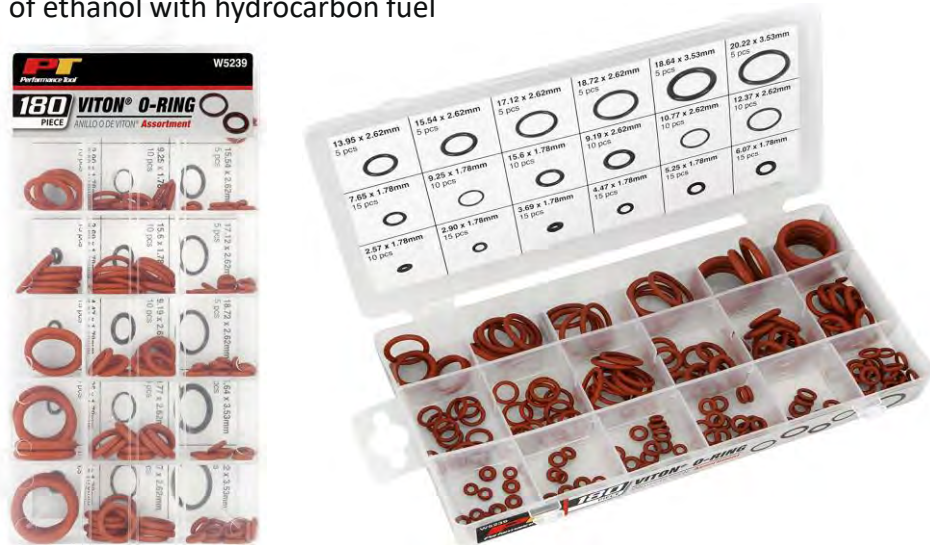

### 00198-22 (FJC 4275) 350 pc Air Condition O-Ring

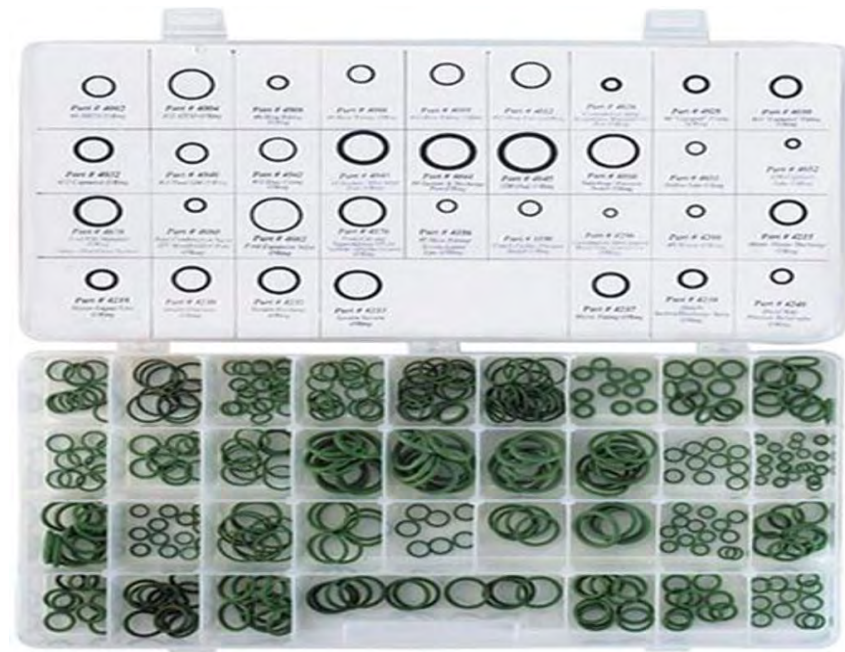

00198-22 (FJC 4278) 180 pc Air Condition O-Ring

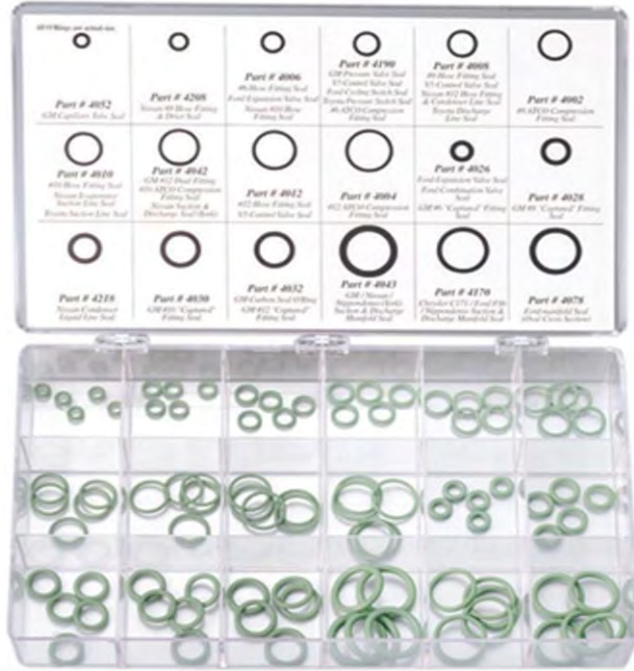

00198-22 (FJC 4299) 180 pc Air Condition O-Ring



00198-5 (W5202) 407 Pc O-Ring Assortment



00198-6 (W5203) 419 pc Metric O-Ring Assortment



## 00198-9 (W5201) 270 Pc HNBR O-Ring Assortment

This 270 piece HNBR o-ring assortment kit contains 18 popular sizes: (20) 7/32 x 1/16", (20) 1/4 x 1/16", (20) 6.8 x 1.9, (20) 5/16 x 1/16", (20) 7.8 x 1.9, (20) 8 x 2, (20) 8.8 x 1.9, (15) 7/16 x 1/16", (15) 7/16 x 3/32", (15) 11 x 2, (15) 12 x 2, (10) 13.9 x 1.8, (10) 9/16 x 3/32", (10) 14 x 2, (10) 15 x 2, (10) 17 x 2, (10) 11/16 x 1/16", and (10) 11/16 x 1/8".

Hydrogenated Nitrile Butadiene Rubber (HNBR), also known as Highly Saturated Nitrile (HSN) is special class of nitrile rubber (NBR) and is for mission critical applications. HNBR can be formulated to meet application temperatures ranging between -45 degrees C and 165 degrees C.



## 00203-20 (W5215) 160 Pc Nutsert Assortment

160Pcs Rivnuts Nutserts Kit, SAE Rivet Nuts Assortment UNC Threaded RIV Nut Sert, 1/4-20, 3/8-16, 5/16-18, 10-24, 8-32, 6-32



## 00203-50 192 pc Rivnut Tool with Mandrels

13pcs interchangeable mandrels: M3, M4, M5, M6, M8, M10, M12, 8-32, 10-24, 1/4-20, 5/16-18, 3/8-16, 1/2-13, 192pcs rivnuts. Professional rivnut tool set meet multiple riveting cases.



## 00203-75 30pc Snap Setting Tool Assortment

•YZS snap setter tool comes with extra fasteners – 10 Pcs Set button snap studs, 10 Pcs screw with Phillips head, 10 pads for snap caps



## 00396-20 (W5215) 70 Pc Grease Fitting Assortment



1/4 in. - 28 Straight 20 pcs	1/8 in. - NPT Straight 10 pcs	6 mm - 1 Straight 10 pcs	1/4 in. - 28 45° 5 pcs	1/8 in. - NPT 45° 5 pcs	8 mm - 1 Straight 5 pcs
			1/4 in. - 28 90° 5 pcs	1/8 in. - NPT 90° 5 pcs	10 mm - 1 Straight 5 pcs

## 00472-25 135 Pc Krimp / Seal Assortment



## 00476-29 329 Pc Weather Pack Assortment

23 Sets Waterproof Connector 1/2/3/4/6 Pin  
Automotive Connectors 20-14AWG Wire Harness  
Connectors with Terminals...



## 00477-19 188 Pc Deutsch DT Assortment

188PCS Deutsch Connector Kit, 8 Sets 2/3/4/6/8/12 Pin  
Automotive Waterproof Car Electrical Wire Connectors  
Plug for Motorcycle, Truck, Car, Boats,...



00512-10 340 Pc fuse Assortment



00512-15 30pc J-case Tall & Short Fuse Assortment



00512-20 (W5368) 120 ATO Fuse Assortment



00512-30 (W5369) 120 Mini Fuse Assortment



## 00512-40 (W5370) 33 Master Fuse Assortment

•Sizes: 5 - 10A Standard, 5 - 10A Mini, 3 - 30A Standard, 3 - 30A Mini, 3 - 20A Standard, 3 - 20A Mini, 4 - 5A Standard



## 00512-50 (W5374) 16pc Maxi Fuse Assortment

•Sizes: 2 - 20A, 2 - 30A, 2 - 40A, 2 - 50A, 2 - 60A, 2 - 70A, 2 - 80A



## 00512-60 (W5376) 15pc Micro Fuse Assortment

•Sizes: 2 - 20A, 2 - 30A, 2 - 40A, 2 - 50A, 2 - 60A, 2 - 70A, 2 - 80A



## 00512-70 (W5375) 70pc Glass Fuse Assortment

•Sizes: 10 - 5A Fuses, 10 - 10A Fuses, 10 - 15A Fuses, 10 - 20A Fuses, 10 - 25A Fuses, 10 - 30A Fuses,



### 00535-20 12 Sizes Vacuum Conn Assortment



### 00535-30 80 pc Vacuum Cap Assortment

Vacuum Hose Caps, Connector Assortment 6 Sizes Black Rubber Cap, Automotive Topomatic Replacement Parts for Carburetor Vacuum Plugs, Intake Manifold...



### 00549-20 (W5214) 125pc Grommet Assortment



### 00555-20 Push Pin Retainer Assortment

•UNIVERSAL FIT KIT - Great Assortment Push Retainer Kit with 12 popular size, fitting for door trim, radiator shield yoke, fender, bumper and splash shield retainers replacement for Ford, GM, Chrysler, Toyota, Honda and more.





# PHILLIP HEAD MACHINE SCREWS



**PART # 00141-16**

**WWW.CFISGROUP.COM**

CANTON FLEET – INDUSTRIAL SUPPLY/ COLUMBUS FLEET INDUSTRIAL SUPPLY  
(614-332-7464)































**CANTON FLEET - INDUSTRIAL SUPPLY  
COLUMBUS FLEET - INDUSTRIAL SUPPLY**

**www.cfisgroup.com  
(614) 332-7464**

## **PART # 0141-16 ASSORTMENT: METRIC PHIL MACHINE SCREW**

01/22

131-008 25 	141-184 10 	141-186 10 	141-188 10 	141-190 10 	141-192 10 
8-1.25 NUT 25	8-1.25 X 16 141-160 25 	8-1.25 X 20 141-162 25 	8-1.25 X 25 141-164 25 	8-1.25 X 30 141-166 15 	8-1.25 X 35 141-168 15 
6-1-00 NUT 131-005 	6-1.00 X 10 141-140 	6-1.00 X 12 141-142 	6-1.00 X 16 141-146 	6-1.00 X 20 141-148 	6-1.00 X 25 141-150 
6-1-00 NUT 131-004 	5-80 X 8 141-125 	5-80 X 10 141-127 	5-80 X 16 141-129 	5-80 X 20 141-131 	5-80 X 25 141-134 
6-1-00 NUT 	4-70 X 8 	4-70 X 10 	4-70 X 16 	4-70 X 20 	4-70 X 30 



# PHILLIP HEAD MACHINE SCREWS



**PART # 00141-20**

**WWW.CFISGROUP.COM**

























**CANTON FLEET - INDUSTRIAL SUPPLY COLUMBUS FLEET - INDUSTRIAL SUPPLY**  
**(330) 408-7374 Fax: (330) 408-7262**



**CANTON FLEET - INDUSTRIAL SUPPLY  
COLUMBUS FLEET - INDUSTRIAL SUPPLY**

**www.cfisgroup.com  
(614) 332-7464**

**PART # 0141-20 ASSORTMENT: METRIC PHIL MACHINE SCREW** <sup>01/22</sup>

131-036 25 6 MM FLATS 	131-038 25 8 MM FLATS 	131-040 25 10 MM FLATS 	131-066 10 6 MM LOCKS 	131-068 10 8 MM LOCKS 	131-070 10 10 MM LOCKS 
131-010 25 10-1.50 NUT 	141-204 25 10-1.50 X 20 	141-206 25 10-1.50 X 25 	141-208 25 10-1.50 X 30 	141-210 25 10-1.50 X 35 	141-212 25 10-1.50 X 40 
131-008 25 8-1.25 NUT 	141-184 25 8-1.25 X 16 	141-186 25 8-1.25 X 20 	141-188 25 8-1.25 X 25 	141-190 25 8-1.25 X 30 	141-192 25 8-1.25 X 35 
131-006 25 6-1.00 NUT 	141-160 25 6-1.00 X 10 	141-162 25 6-1.00 X 12 	141-164 25 6-1.00 X 16 	141-166 25 6-1.00 X 20 	141-168 25 6-1.00 X 25 



# MACHINE NUTS, FLATS, LOCKS



PART # 00121-10

[WWW.CFISGROUP.COM](http://WWW.CFISGROUP.COM)











CANTON FLEET - INDUSTRIAL SUPPLY COLUMBUS FLEET - INDUSTRIAL SUPPLY  
(614) 332-7464

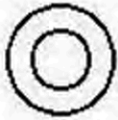
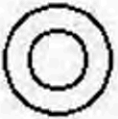

# MACHINE NUTS, FLATS, LOCKS

PART # 00121-10

06/15

121010  8-32 NUT 100	121012  10-24 NUT 100	121016  12-24 NUT 50	121018  1/4-20 NUT 50	121325  # 8 LOCK 200	121326  # 10 LOCK 200
121205  # 8 200	121206  # 10 200	121207  # 12 100	121208  # 14 100	121327  #12 LOCK 100	121328  # 14 LOCK 100



# PHILLIP HEAD MACHINE SCREWS



**PART # 00141-16**

**WWW.CFISGROUP.COM**



















**CANTON FLEET - INDUSTRIAL SUPPLY COLUMBUS FLEET - INDUSTRIAL SUPPLY**  
(614) 332-7464



# PHILLIP HEAD MACHINE SCREWS

**PART # 00165-10**

06/15

165052  8-32 X 1/2 25	165054  8-32 X 3/4 25	165055  8-32 X 1 25	165056  8-32 X 1-1/4 25	165057  8-32 X 1-1/2 25	165073  10-24 X 1/2 25
165074  10-24 X 3/4 25	165075  10-24 X 1 25	165076  10-24 X 1-1/4 25	165077  10-24 X 1-1/2 25	165122  12-24 X 1/2 25	165125  12-24 X 3/4 25
165126  12-24 X 1 25	165128  12-24 X 1/2 25	165154  1/4-20 X 3/4 15	165155  1/4-20 X 1 15	165156  1/4-20 X 1-1/4 15	165175  1/4-20 X 1-1/2 15



# PHILLIP HEAD MACHINE SCREWS



**PART # 00165-25**

**WWW.CFISGROUP.COM**



















**CANTON FLEET - INDUSTRIAL SUPPLY COLUMBUS FLEET - INDUSTRIAL SUPPLY**  
**(614) 332-7464**



# PHILLIP HEAD MACHINE SCREWS

**PART # 00165-25**

06/15

165114  10-32 X 3/4 25	165115  10-32 X 1 25	165117  10-32 X 1-1/2 25	121016  12-24 NUT 25	165125  12-24 X 3/4 25	165126  12-24 X 1 25
165054  8-32 X 3/4 25	165055  8-32 X 1 25	165057  8-32 X 1-1/2 25	165074  10-24 X 3/4 25	165075  10-24 X 1 25	165077  10-24 X 1-1/2 25
121008  6-32 NUT 25	121010  8-32 NUT 25	121012  10-24 NUT 25	121014  10-32 NUT 25	165034  6-32 X 3/4 25	165035  6-32 X 1 25



# COTTER PINS



**PART # 00191-10**

**WWW.CFISGROUP.COM**

**CANTON FLEET - INDUSTRIAL SUPPLY COLUMBUS FLEET - INDUSTRIAL SUPPLY  
(330) 408-7374**



**PART # 00191-10**

# COTTER PINS

06/15

191000		1/16 X 1/2 25	191002		1/16 X 1 25	191042		3/32 X 1 25	191044		3/32 X 1-1/2 25	191082		1/8 X 1 25	191084		1/8 X 1-1/2 25
191086		1/8 X 2 25	191095		5/32 X 1-1/2 25	191097		5/32 X 2 25	191200		3/16 X 3/4 25	191204		3/16 X 1-1/2 25	191206		3/16 X 2 25



# ASSORTMENT: KRIMP & SEAL



**PART # 00472-10**

# WWW.CFISGROUP.COM

CANTON FLEET - INDUSTRIAL SUPPLY/ COLUMBUS FLEET INDUSTRIAL SUPPLY  
(614-332-7464)



**CANTON FLEET - INDUSTRIAL SUPPLY  
COLUMBUS FLEET - INDUSTRIAL SUPPLY**

WWW.cfisgroup.com  
(614) 332-7464

**PART # 00472-10**

**ASSORTMENT: KRIMP & SEAL (PLASTIC DRAWER)**

01/22

472-034 10 	471-035 10 	471-034 10 	471-005 10 	471-003 10 	471-000 25 
16-14 MALE 472-035 10 	22-18 FEMALE 472-007 10 	22-18 MALE 472-006 10 	22-18 1/4 RING 472-005 10 	22-18 10 RING 472-003 10 	22-18 BUTT 472-000 25 
16-14 FEMALE 472-013 10 	16-14 3/8 RING 470-090 10 	16-14 5/16 RING 470-091 10 	16-14 1/4 RING 470-092 5 	16-14 10 RING 473-035 10 	16-14 BUTT 473-034 10 
16-14 10 FORK 473-008 10 	22-18 / 16-14 473-007 10 	16-14 / 12-10 473-006 10 	12-10 / 8 Ga 473-005 10 	12-10 FEMALE 473-003 10 	12-10 MALE 473-000 15 
12-10 1/2 RING 	12-10 3/8 RING 	12-10 5/16 RING 	12-10 1/4 RING 	12-10 10 RING 	12-10 BUTT 



# ASSORTMENT KRIMP & SEAL



**PART # 0472-14**

# WWW.CFISGROUP.COM

CANTON FLEET – INDUSTRIAL SUPPLY/ COLUMBUS FLEET INDUSTRIAL SUPPLY  
(614-332-7464)























CANTON FLEET - INDUSTRIAL SUPPLY  
COLUMBUS FLEET - INDUSTRIAL SUPPLY

WWW.cfisgroup.com  
(614) 332-7464

**PART # 00472-14**

**ASSORTMENT: KRIMP & SEAL (PLASTIC DRAWER)**

01/22

473-008 10 	12-10 1/2 RING	473-007 10 	12-10 3/8 RING	473-006 10 	12-10 5/16 RING	473-005 10 	12-10 1/4 RING	473-003 10 	12-10 10 RING	473-000 25 	12-10 BUTT
472-035 10 	16-14 FEMALE	472-034 10 	16-14 MALE	472-025 10 	16-14 FEMALE	472-024 10 	16-14 MALE	472-013 10 	12-10 10 FORK	472-000 25 	16-14 BUTT
472-013 10 	16-14 10 FORK	471-034 10 	22-18 MALE	471-013 10 	22-18 10 FORK	471-005 10 	22-18 1/4 RING	471-003 10 	22-18 10 RING	471-000 10 	22-18 BUTT
471-035 10 	22-18 FEMALE									470-098 15 	24 GAUGE BUTT



# ASSORTMENT KRIMP & SEAL



**PART # 0472-18**

# WWW.CFISGROUP.COM

CANTON FLEET - INDUSTRIAL SUPPLY/ COLUMBUS FLEET INDUSTRIAL SUPPLY  
(614-332-7464)



CANTON FLEET - INDUSTRIAL SUPPLY  
COLUMBUS FLEET - INDUSTRIAL SUPPLY

WWW.cfisgroup.com  
(614) 332-7464

**PART # 00472-18**

**ASSORTMENT: KRIMP & SEAL (PLASTIC DRAWER)**

01/22

471-035 10 	471-034 10 	471-005 10 	471-003 10 	471-000 10 
22-18 FEMALE 472-007 10 	22-18 MALE 472-006 10 	22-18 1/4 RING 472-005 10 	22-18 10 RING 472-003 10 	22-18 BUTT 472-000 10 
16-14 3/8 RING 472-035 10 	16-14 5/16 RING 472-034 10 	16-14 1/4 RING 472-013 10 	16-14 10 RING 473-035 10 	16-14 BUTT 473-034 10 
16-14 FEMALE 473-008 10 	16-14 MALE 473-007 10 	16-14 10 FORK 473-005 10 	12-10 FEMALE 473-003 10 	12-10 MALE 473-000 10 
12-10 1/2 RING	12-10 3/8 RING	12-10 1/4 RING	12-10 10 RING	12-10 BUTT



# AT SERIES CONNECTORS



**PART # 477-150**

**WWW.CFISGROUP.COM**

**CANTON FLEET - INDUSTRIAL SUPPLY COLUMBUS FLEET - INDUSTRIAL SUPPLY**  
**(614) 332-7464**



**PART # 477-150**

# AT SERIES CONNECTORS

03/17

<p>477-160 2-way plug</p>  <p>477-182 2-way plug wedge</p> 	<p>477-162 3-way plug</p>  <p>477-184 3-way plug wedge</p> 	<p>477-164 4-way plug</p>  <p>477-186 4-way plug wedge</p> 	<p>477-166 6-way plug</p>  <p>477-188 6-way plug wedge</p> 	<p>477-168 8-way plug</p>  <p>477-190 8-way plug wedge</p> 	<p>477-170 12-way plug</p>  <p>477-192 12-way plug wedge</p> 	<p>477-172 2-way receptacle</p>  <p>477-202 2-way recp. wedge</p> 	<p>477-174 3-way receptacle</p>  <p>477-204 3-way recp. wedge</p> 	<p>477-176 4-way receptacle</p>  <p>477-206 4-way recp. wedge</p> 	<p>477-178 6-way receptacle</p>  <p>477-208 6-way recp. wedge</p> 	<p>477-180 8-way receptacle</p>  <p>477-210 8-way recp. wedge</p> 	<p>477-192 12-way plug receptacle</p> 	<p>477-220 16-18 fem socket</p> 	<p>477-222 16-18 fem socket4</p> 	<p>477-224 16-18 Male pin</p> 	<p>477-226 16-18 male pin</p> 	<p>477-228 Sealing plug</p> 	<p>477-181 12 way recp</p> 
---	---	---	---	---	---	--	--	--	--	--	---	---	--	--	---	---	--



# AT SERIES CONNECTORS



**PART # 477-155**

**WWW.CFISGROUP.COM**

**CANTON FLEET - INDUSTRIAL SUPPLY COLUMBUS FLEET - INDUSTRIAL SUPPLY**  
**(614) 332-7464**



**PART # 477-155**

# AT SERIES CONNECTORS

06/15

Crimp Tool  
part # 990170

<b>Socket Contact</b> Stamped/Formatted 16-18 Gauge part # 14621622	<b>Pin Contact</b> Stamped/Formatted 16-18 Gauge part # 14601622	<b>4-way Plug Housing</b> part # 14064100  <b>4-way Plug Wedge</b> part # 14164100	<b>4-way Plug Housing</b> part # 14064100  <b>4-way Plug Wedge</b> part # 14164100	<b>Socket Contact</b> Stamped/Formatted 14-16 Gauge part # 14621422	<b>Pin Contact</b> Stamped/Formatted 14-16 Gauge part # 14601422
<b>3-way Plug Housing</b> part # 14063100  <b>3-way Plug Wedge</b> part # 14163100	<b>3-way Receptacle Housing</b> part # 14063200  <b>3-way Receptacle Wedge</b> part # 14163200	<b>4-way Receptacle Housing</b> part # 14064200  <b>4-way Receptacle Wedge</b> part # 14164200	<b>4-way Receptacle Housing</b> part # 14064200  <b>4-way Receptacle Wedge</b> part # 14164200	<b>2-way Plug Housing</b> part # 14062100  <b>2-way Plug Wedge</b> part # 14162100	<b>2-way Receptacle Housing</b> part # 14062200  <b>2-way Receptacle Wedge</b> part # 14162200

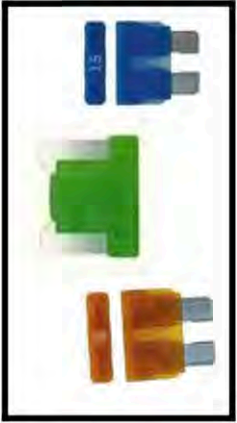

# ATO & ATC FUSES



**PART # 512-80**

**WWW.CFISGROUP.COM**

**CANTON FLEET - INDUSTRIAL SUPPLY COLUMBUS FLEET - INDUSTRIAL SUPPLY**  
**(614) 332-7464**



**CANTON FLEET - INDUSTRIAL SUPPLY**  
**COLUMBUS FLEET - INDUSTRIAL SUPPLY**

**www.cfisgroup.com**  
**(614) 332-7464**

**PART # 0512-80**

## ASSORTMENT: FUSES

01/22

512-405 10		512-407 10		512-410 10		512-415 10		512-420 10		512-425 10	
MINI-ATC-5		MINI-ATC-7-1/2		MINI-ATC-10		MINI-ATC-15		MINI-ATC-20		MINI-ATC-25	
512-330 10		512-340 10		512-440 5		512-442 5		512-444 5		512-430 10	
ATO-30		ATO-40		15 amp Low Profile		20 amp Low Profile		30 amp Low Profile		MINI-ATC-30	
512-305 10		512-307 10		512-310 10		512-315 10		512-320 10		512-325 10	
ATO-5		ATO-7-1/2		ATO-10		ATO-15		ATO-20		ATO-25	



# MICRO 2 / 3 AND J-CASE FUSES



**PART # 512-82**

**WWW.CFISGROUP.COM**

**CANTON FLEET - INDUSTRIAL SUPPLY COLUMBUS FLEET - INDUSTRIAL SUPPLY**  
**(614) 332-7464**



**CANTON FLEET - INDUSTRIAL SUPPLY**  
**COLUMBUS FLEET - INDUSTRIAL SUPPLY**

**WWW.cfisgroup.com**  
**(614) 332-7464**

**PART # 0512-82**

**ASSORTMENT: FUSES**













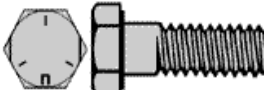





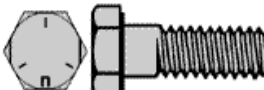

01/22

512-720	1		20 amp J-Case	512-380	5		5 amp MICRO-3	512-360	5		5 AMP MICRO-2
512-725	1		25 amp J-Case	512-381	5		7.5 amp MICRO-3	512-362	5		7.5 AMP MICRO-2
512-730	1		30 amp J-Case	512-382	5		10 amp MICRO-3	512-364	5		10 AMP MICRO-2
512-740	1		40 amp J-Case	512-383	5		15 amp MICRO-3	512-366	5		15 AMP MICRO-2
512-750	1		50 amp J-Case	512-774	1		30 amp J-Case Low	512-368	5		20 AMP MICRO-2
512-760	1		60 amp J-Case	512-372	5		30 AMP MICRO-2	512-370	5		25 AMP MICRO-2

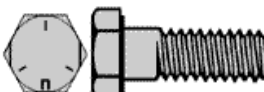
PART # 0106-25

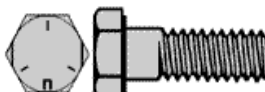
**ASSORTMENT: USS BOLTS GRADE 5**

01/22

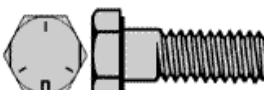
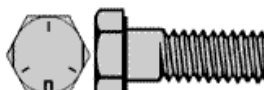
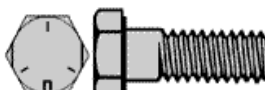
<p>118205 25</p>  <p>1/2-13 NUT</p>	<p>118408 25</p>  <p>1/2 LOCKS</p>	<p>118425 25</p>  <p>1/2 FLATS</p>	<p>106212 10</p>  <p>1/2-13 X 1</p>	<p>106216 10</p>  <p>1/2-13 X 1-1/2</p>	<p>106220 10</p>  <p>1/2-13 X 2</p>
<p>118202 25</p>  <p>3/8-16 NUT</p>	<p>118406 25</p>  <p>3/8 LOCKS</p>	<p>118423 25</p>  <p>3/8 FLATS</p>	<p>106112 15</p>  <p>3/8-16 X 1</p>	<p>106116 15</p>  <p>3/8-16 X 1-1/2</p>	<p>106120 15</p>  <p>3/8-16 X 2</p>
<p>118201 25</p>  <p>5/16-18 NUT</p>	<p>118405 25</p>  <p>5/16 LOCKS</p>	<p>118422 25</p>  <p>5/16 FLATS</p>	<p>106062 20</p>  <p>5/16-18 X 1</p>	<p>106066 20</p>  <p>5/16-18 X 1-1/2</p>	<p>106070 20</p>  <p>5/16 X 2</p>
<p>118200 25</p>  <p>1/4-20 NUT</p>	<p>118404 25</p>  <p>1/4 LOCKS</p>	<p>118421 25</p>  <p>1/4 FLATS</p>	<p>106010 20</p>  <p>1/4-20 X 3/4</p>	<p>106012 20</p>  <p>1/4-20 X 1</p>	<p>106016 20</p>  <p>1/4-20 X 1-1/2</p>

PART # 0106-30

# ASSORTMENT: USS BOLTS GRADE 5

01/22

106316

10

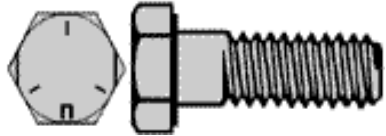

5/8-11 X 1-1/2

106324

10

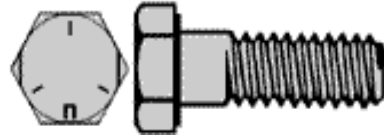

5/8-11 X 2-1/2

106368

10

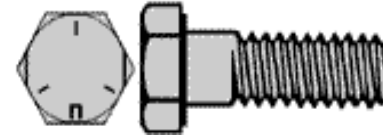

3/4-10 X 1-3/4

106314

10

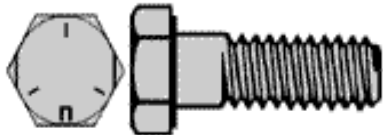

5/8-11 X 1-1/4

106320

10

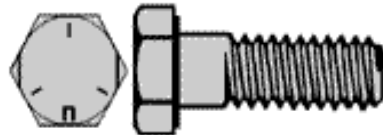

5/8-11 X 2

106366

10

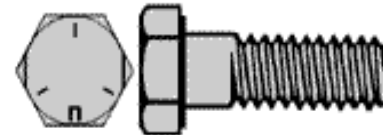

3/4-10 X 1-1/2

106374

10

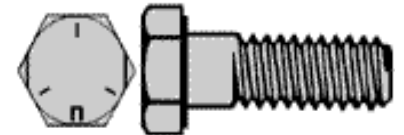

3/4-10 X 2-1/2

118207

10



5/8-11 NUTS

106318

10

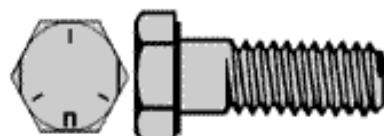

5/8-11 X 1-3/4

118208

10



3/4-10 NUTS

106370

10

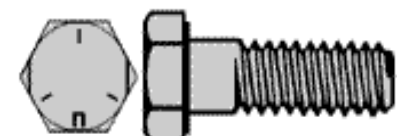







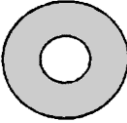
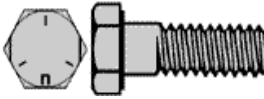
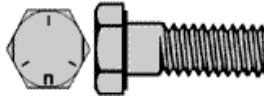
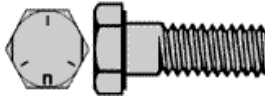

3/4-10 X 2

PART # 0106-35

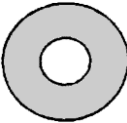
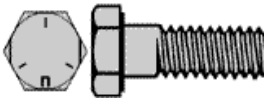
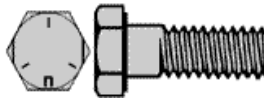
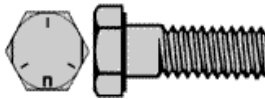
**ASSORTMENT: SAE BOLTS GRADE 5**

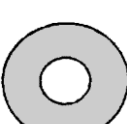
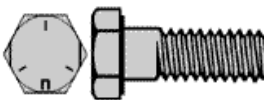
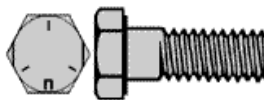
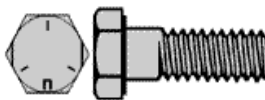

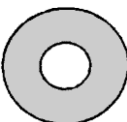
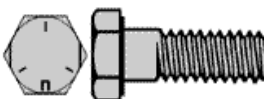
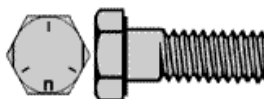
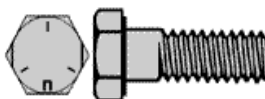



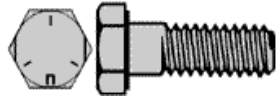
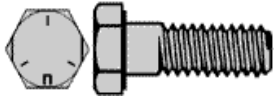
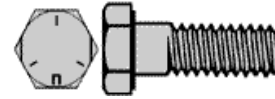
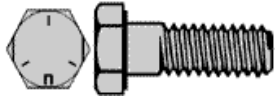
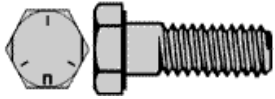

01/22

<p>118225 25</p>  <p>1/2-20 NUT</p>	<p>118408 25</p>  <p>1/2 LOCKS</p>	<p>118445 25</p>  <p>1/2 FLATS</p>	<p>106712 10</p>  <p>1/2-20 X 1</p>	<p>106716 10</p>  <p>1/2-20 X 1-1/2</p>	<p>106720 10</p>  <p>1/2-20 X 2</p>
<p>118222 25</p>  <p>3/8-24 NUT</p>	<p>118406 25</p>  <p>3/8 LOCKS</p>	<p>118443 25</p>  <p>3/8 FLATS</p>	<p>106612 15</p>  <p>3/8-24 X 1</p>	<p>106616 15</p>  <p>3/8-24 X 1-1/2</p>	<p>106620 15</p>  <p>3/8-24 X 2</p>
<p>118221 25</p>  <p>5/16-24 NUT</p>	<p>118405 25</p>  <p>5/16 LOCKS</p>	<p>118442 25</p>  <p>5/16 FLATS</p>	<p>106562 20</p>  <p>5/16-24 X 1</p>	<p>106566 20</p>  <p>5/16-24 X 1-1/2</p>	<p>106570 20</p>  <p>5/16-24 X 2</p>
<p>118220 25</p>  <p>1/4-28 NUT</p>	<p>118404 25</p>  <p>1/4 LOCKS</p>	<p>118441 25</p>  <p>1/4 FLATS</p>	<p>106510 20</p>  <p>1/4-28 X 3/4</p>	<p>106512 20</p>  <p>1/4-28 X 1</p>	<p>106516 20</p>  <p>1/4-28 X 1-1/2</p>

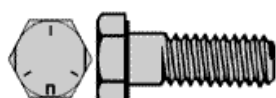
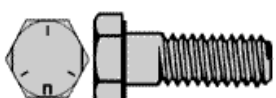
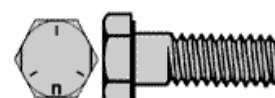
PART # 0106-36

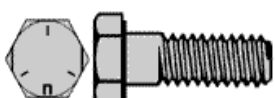
**ASSORTMENT: SAE BOLTS GRADE 5**

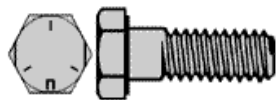
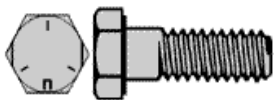
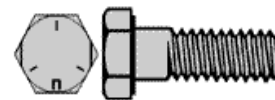
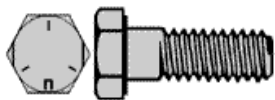
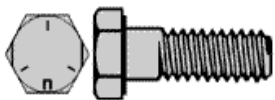
01/22

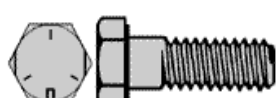
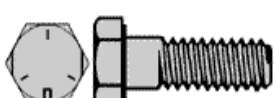
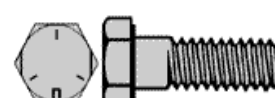
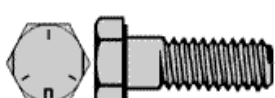
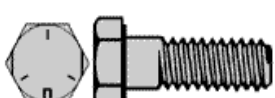
<p>118225 25</p>  <p>1/2-20 NUT</p>	<p>106-712 10</p>  <p>1/2-20 X 1</p>	<p>106-714 10</p>  <p>1/2-20 X 1-1/4</p>	<p>106-716 10</p>  <p>1/2-20 X 1-1/2</p>	<p>106-718 10</p>  <p>1/2-20 X 1-3/4</p>	<p>106-720 10</p>  <p>1/2-20 X 2</p>
<p>118222 25</p>  <p>3/8-24 NUT</p>	<p>106-612 15</p>  <p>3/8-24 X 1</p>	<p>106-614 15</p>  <p>3/8-24 X 1-1/4</p>	<p>106-616 15</p>  <p>3/8-24 X 1-1/2</p>	<p>106-618 15</p>  <p>3/8-24 X 1-3/4</p>	<p>106620 15</p>  <p>3/8-24 X 2</p>
<p>118221 25</p>  <p>5/16-24 NUT</p>	<p>106-560 20</p>  <p>5/16-24 X 3/4</p>	<p>106-562 20</p>  <p>5/16-24 X 1</p>	<p>106-564 20</p>  <p>5/16-24 X 1-1/4</p>	<p>106-566 20</p>  <p>5/16-24 X 1-1/2</p>	<p>106-570 20</p>  <p>5/16-24 X 2</p>
<p>118220 25</p>  <p>1/4-28 NUT</p>	<p>106-510 20</p>  <p>1/4-28 X 3/4</p>	<p>106-512 20</p>  <p>1/4-28 X 1</p>	<p>106-514 20</p>  <p>1/4-28 X 1-1/4</p>	<p>106-516 20</p>  <p>1/4-28 X 1-1/2</p>	<p>106-520 20</p>  <p>1/4-28 X 2</p>

PART # 0106-40

# ASSORTMENT: SAE BOLTS GRADE 5

01/22

106816

10

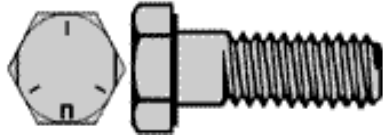

5/8-18 X 1-1/2

106824

10

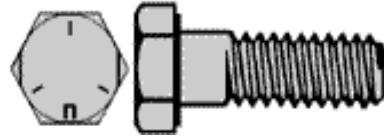

5/8-18 X 2-1/2

106868

10

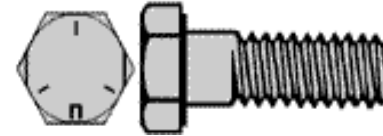

3/4-16 X 1-3/4

106814

10

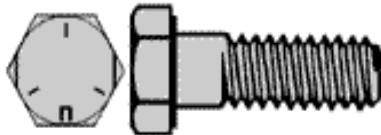

5/8-18 X 1-1/4

106820

10

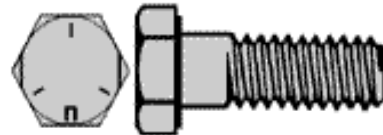

5/8-18 X 2

106866

10

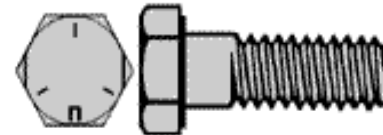

3/4-16 X 1-1/2

106874

10

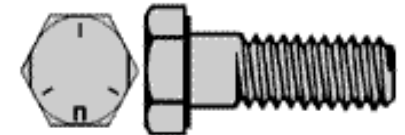

3/4-16 X 2-1/2

118227

10



5/8-18 NUTS

106818

10

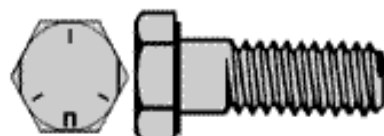

5/8-18 X 1-3/4

118228

10



3/4-16 NUTS

106870

10

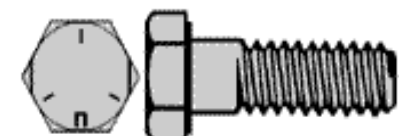











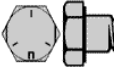
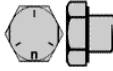
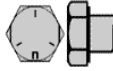
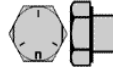
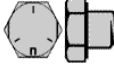



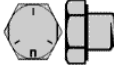
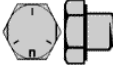
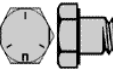
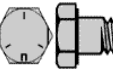
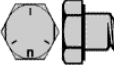

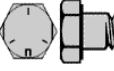
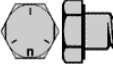
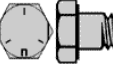
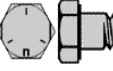
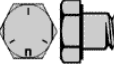

3/4-16 X 2

PART # 0106-45

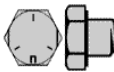
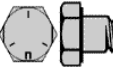
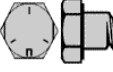
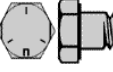
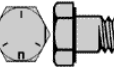
**ASSORTMENT: USS BOLTS GRADE 5**

01/22

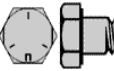
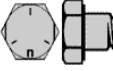
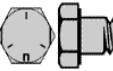
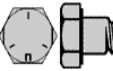
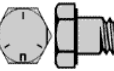









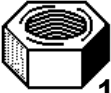

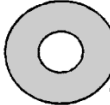
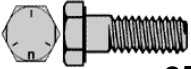
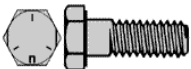
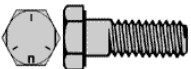
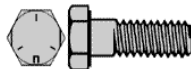
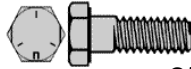
<p><b>118-200</b></p>  <p>100</p> <p>1/4-20 NUT</p>	<p><b>118-404</b></p>  <p>200</p> <p>1/4 LOCKS</p>	<p><b>118-421</b></p>  <p>100</p> <p>1/4 FLATS</p>	<p><b>106-006</b></p>  <p>25</p> <p>1/4-20 X 1/2</p>	<p><b>106-010</b></p>  <p>25</p> <p>1/4-20 X 3/4</p>	<p><b>106-012</b></p>  <p>25</p> <p>1/4-20 X 1</p>	<p><b>106-014</b></p>  <p>25</p> <p>1/4-20 X 1-1/4</p>	<p><b>106-016</b></p>  <p>25</p> <p>1/4-20 X 1-1/2</p>
<p><b>118-201</b></p>  <p>100</p> <p>5/16-18 NUT</p>	<p><b>118-405</b></p>  <p>200</p> <p>5/16 LOCKS</p>	<p><b>118-422</b></p>  <p>100</p> <p>5/16 FLATS</p>	<p><b>106-060</b></p>  <p>25</p> <p>5/16-18 X 3/4</p>	<p><b>106-062</b></p>  <p>25</p> <p>5/16-18 X 1</p>	<p><b>106-064</b></p>  <p>25</p> <p>5/16-18 X 1-1/4</p>	<p><b>106-066</b></p>  <p>25</p> <p>5/16-18 X 1-1/2</p>	<p><b>106-070</b></p>  <p>25</p> <p>5/16-18 X 2</p>
<p><b>118-202</b></p>  <p>100</p> <p>3/8-16 NUT</p>	<p><b>118-406</b></p>  <p>100</p> <p>3/8 LOCKS</p>	<p><b>118-423</b></p>  <p>100</p> <p>3/8 FLATS</p>	<p><b>106-110</b></p>  <p>25</p> <p>3/8-16 X 3/4</p>	<p><b>106-112</b></p>  <p>25</p> <p>3/8-16 X 1</p>	<p><b>106-114</b></p>  <p>25</p> <p>3/8-16 X 1-1/4</p>	<p><b>106-116</b></p>  <p>25</p> <p>3/8-16 X 1-1/2</p>	<p><b>106-120</b></p>  <p>25</p> <p>3/8-16 X 2</p>
<p><b>118-203</b></p>  <p>50</p> <p>7/16-14 NUT</p>	<p><b>118-407</b></p>  <p>50</p> <p>7/16 LOCKS</p>	<p><b>118-424</b></p>  <p>50</p> <p>7/16 FLATS</p>	<p><b>106-162</b></p>  <p>15</p> <p>7/16-14 X 1</p>	<p><b>106-166</b></p>  <p>15</p> <p>7/16-14 X 1-1/2</p>	<p><b>106-170</b></p>  <p>15</p> <p>7/16-14 X 2</p>	<p><b>106-228</b></p>  <p>10</p> <p>1/3-13 X 3</p>	<p><b>106-224</b></p>  <p>10</p> <p>1/2-13 X 2-1/2</p>
<p><b>118-205</b></p>  <p>50</p> <p>1/2-13 NUT</p>	<p><b>118-408</b></p>  <p>50</p> <p>1/2 LOCKS</p>	<p><b>118-425</b></p>  <p>50</p> <p>1/2 FLATS</p>	<p><b>106-214</b></p>  <p>15</p> <p>1/2-13 X 1-1/4</p>	<p><b>106-216</b></p>  <p>15</p> <p>1/3-13 X 1-1/2</p>	<p><b>106-218</b></p>  <p>15</p> <p>1/2-13 X 1-3/4</p>	<p><b>106-220</b></p>  <p>15</p> <p>1/2-13 X 2</p>	<p><b>106-222</b></p>  <p>10</p> <p>1/2-13 X 2-1/4</p>

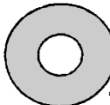
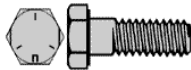
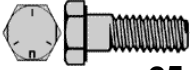

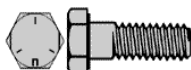
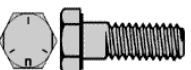
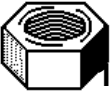
PART # 0106-50

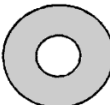
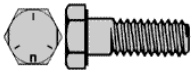
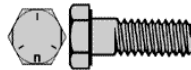
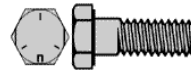
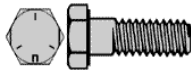
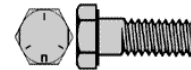

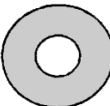
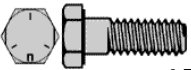
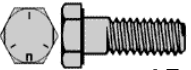
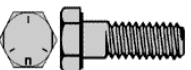
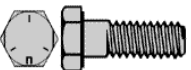
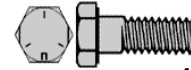
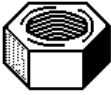

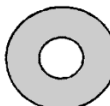
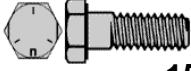
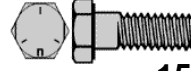
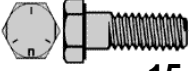
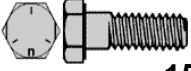
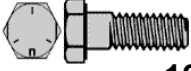









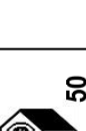



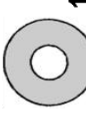

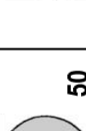

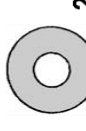



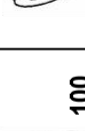



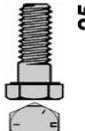
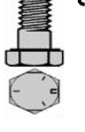
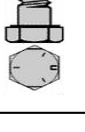



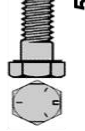
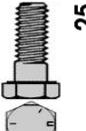
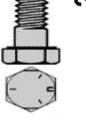
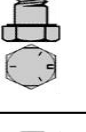

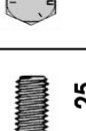

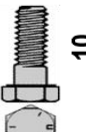
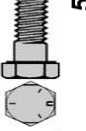
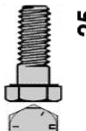

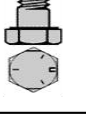

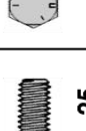

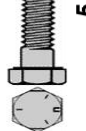
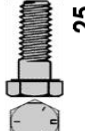
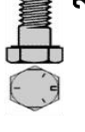
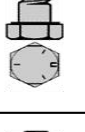

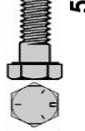

**ASSORTMENT: SAE BOLTS GRADE 5**

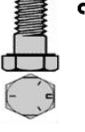
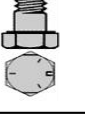
01/22

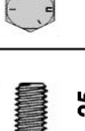
<p><b>118-220</b></p>  <p>100</p> <p>1/4-28 NUT</p>	<p><b>118-404</b></p>  <p>200</p> <p>1/4 LOCKS</p>	<p><b>118-441</b></p>  <p>100</p> <p>1/4 FLATS</p>	<p><b>106-506</b></p>  <p>25</p> <p>1/4-28 X 1/2</p>	<p><b>106-510</b></p>  <p>25</p> <p>1/4-28 X 3/4</p>	<p><b>106-512</b></p>  <p>25</p> <p>1/4-28 X 1</p>	<p><b>106-514</b></p>  <p>25</p> <p>1/4-28 X 1-1/4</p>	<p><b>106-516</b></p>  <p>25</p> <p>1/4-28 X 1-1/2</p>
<p><b>118-221</b></p>  <p>100</p> <p>5/16-24 NUT</p>	<p><b>118-405</b></p>  <p>200</p> <p>5/16 LOCKS</p>	<p><b>118-442</b></p>  <p>100</p> <p>5/16 FLATS</p>	<p><b>106-560</b></p>  <p>25</p> <p>5/16-24 X 3/4</p>	<p><b>106-562</b></p>  <p>25</p> <p>5/16-24 X 1</p>	<p><b>106-564</b></p>  <p>25</p> <p>5/16-24 X 1-1/4</p>	<p><b>106-566</b></p>  <p>25</p> <p>5/16-24 X 1-1/2</p>	<p><b>106-570</b></p>  <p>25</p> <p>5/16-24 X 2</p>
<p><b>118-222</b></p>  <p>100</p> <p>3/8-24 NUT</p>	<p><b>118-406</b></p>  <p>100</p> <p>3/8 LOCKS</p>	<p><b>118-443</b></p>  <p>100</p> <p>3/8 FLATS</p>	<p><b>106-610</b></p>  <p>25</p> <p>3/8-24 X 3/4</p>	<p><b>106-612</b></p>  <p>25</p> <p>3/8-24 X 1</p>	<p><b>106-614</b></p>  <p>25</p> <p>3/8-24 X 1-1/4</p>	<p><b>106-616</b></p>  <p>25</p> <p>3/8-24 X 1-1/2</p>	<p><b>106-620</b></p>  <p>25</p> <p>3/8-24 X 2</p>
<p><b>118-223</b></p>  <p>50</p> <p>7/16-20 NUT</p>	<p><b>118-407</b></p>  <p>50</p> <p>7/16 LOCKS</p>	<p><b>118-444</b></p>  <p>50</p> <p>7/16 FLATS</p>	<p><b>106-662</b></p>  <p>15</p> <p>7/16-20 X 1</p>	<p><b>106-666</b></p>  <p>15</p> <p>7/16-20 X 1-1/2</p>	<p><b>106-670</b></p>  <p>15</p> <p>7/16-20 X 2</p>	<p><b>106-728</b></p>  <p>10</p> <p>1/3-20 X 3</p>	<p><b>106-724</b></p>  <p>10</p> <p>1/2-20 X 2-1/2</p>
<p><b>118-225</b></p>  <p>50</p> <p>1/2-20 NUT</p>	<p><b>118-408</b></p>  <p>50</p> <p>1/2 LOCKS</p>	<p><b>118-445</b></p>  <p>50</p> <p>1/2 FLATS</p>	<p><b>106-714</b></p>  <p>15</p> <p>1/2-20 X 1-1/4</p>	<p><b>106-716</b></p>  <p>15</p> <p>1/3-20 X 1-1/2</p>	<p><b>106-718</b></p>  <p>15</p> <p>1/2-20 X 1-3/4</p>	<p><b>106-720</b></p>  <p>15</p> <p>1/2-20 X 2</p>	<p><b>106-722</b></p>  <p>10</p> <p>1/2-20 X 2-1/4</p>

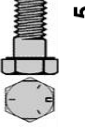
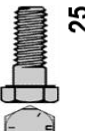
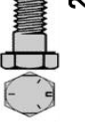
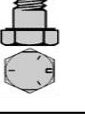

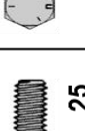









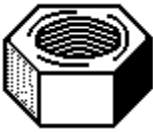

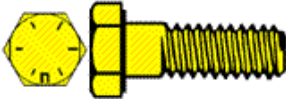
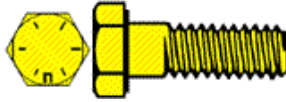
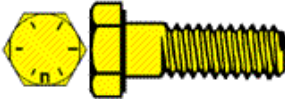
# PART # 0106-42

118-200	 100	1/4-20 NUT	118-201	 100	5/16-18 NUT	118-202	 100	3/8-16 NUT	118-203	 50	7/16-14 NUT	118-205	 50	1/2-13 NUT	118-206	 25	5/8-11 NUT	118-207	 20	3/4-10 NUT	106-124	 25	3/8-16 X 2-1/2
118-421	 100	1/4 FLATS	118-422	 100	5/16 FLATS	118-423	 100	3/8 FLATS	118-424	 50	7/16 FLATS	118-425	 50	1/2 FLATS	118-427	 25	5/8 FLATS	118-428	 20	3/4 FLATS	106-128	 25	3/8-16 X 3
118-404	 200	1/4 LOCKS	118-405	 200	5/16 LOCKS	118-406	 100	3/8 LOCKS	118-407	 100	7/16 LOCKS	118-408	 50	1/2 LOCKS	118-410	 50	5/8 LOCKS	118-411	 25	3/4 LOCKS	106-178	 10	7/16-14 X 3
106-008	 25	1/4-20 X 1/2	106-060	 25	5/16-18 X 3/4	106-110	 25	3/8-16 X 3/4	106-162	 25	7/16-14 X 1	106-212	 25	1/2-13 X 1	106-314	 10	5/8-11 X 1-1/4	106-364	 5	3/4-10 X 1-1/4	106-228	 10	1/2-13 X 3
106-010	 25	1/4-20 X 3/4	106-062	 25	5/16-18 X 1	106-112	 25	3/8-16 X 1	106-164	 25	7/16-14 X 1-1/4	106-214	 25	1/2-13 X 1-1/4	106-316	 10	5/8-11 X 1-1/2	106-366	 5	3/4-10 X 1-1/2	106-328	 5	5/8-11 X 3
106-012	 25	1/4-20 X 1	106-064	 25	5/16-18 X 1-1/4	106-114	 25	3/8-16 X 1-1/4	106-166	 25	7/16-14 X 1-1/2	106-216	 25	1/2-13 X 1-1/2	106-318	 10	5/8-11 X 1-3/4	106-370	 5	3/4-10 X 2	106-332	 5	5/8-11 X 3-1/2
106-014	 25	1/4-20 X 1-1/4	106-066	 25	5/16-18 X 1-1/2	106-116	 25	3/8-16 X 1-1/2	106-168	 25	7/16-14 X 1-3/4	106-218	 25	1/2-13 X 1-3/4	106-320	 10	5/8-11 X 2	106-374	 5	3/4-10 X 2-1/2	106-336	 5	5/8-11 X 4
106-016	 25	1/4-20 X 1-1/2	106-070	 25	5/16-18 X 2	106-120	 25	3/8-16 X 2	106-170	 25	7/16-14 X 2	106-220	 25	1/2-13 X 2	106-322	 10	5/8-11 X 2-1/4	106-378	 5	3/4-10 X 3	106-386	 5	3/4-10 X 4
106-020	 25	1/4-20 X 2	106-074	 25	5/16-18 X 2-1/2	106-122	 25	3/8-16 X 2-1/4	106-174	 25	7/16-14 X 2-1/2	106-224	 25	1/2-13 X 2-1/2	106-324	 10	5/8-11 X 2-1/2	106-382	 5	3/4-10 X 3-1/2			

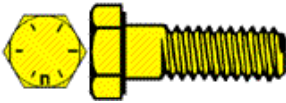
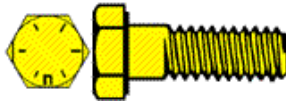
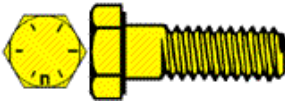
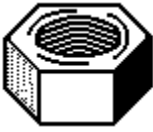
PART # 0107-25

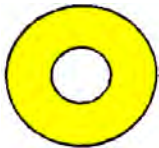
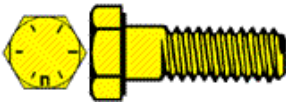
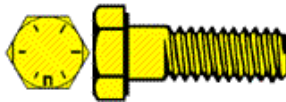
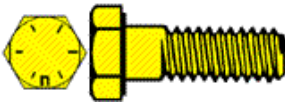
**ASSORTMENT: USS BOLTS GRADE 8**

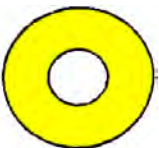
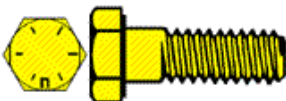
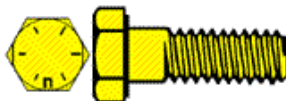







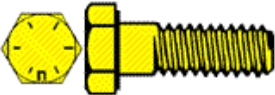
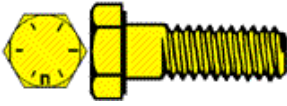
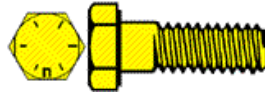
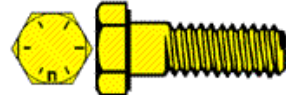

01/22

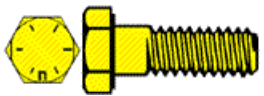
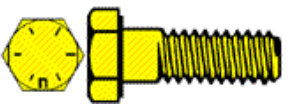
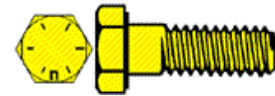
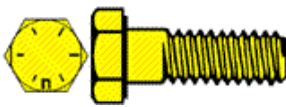
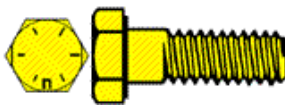
<p>118244 25</p>  <p>1/2-13 NUT</p>	<p>118508 25</p>  <p>1/2 LOCKS</p>	<p>118528 25</p>  <p>1/2 FLATS</p>	<p>107212 10</p>  <p>1/2-13 X 1</p>	<p>107216 10</p>  <p>1/2-13 X 1-1/2</p>	<p>107220 10</p>  <p>1/2-13 X 2</p>
<p>118242 25</p>  <p>3/8-16 NUT</p>	<p>118506 25</p>  <p>3/8 LOCKS</p>	<p>118526 25</p>  <p>3/8 FLATS</p>	<p>107112 15</p>  <p>3/8-16 X 1</p>	<p>107116 15</p>  <p>3/8-16 X 1-1/2</p>	<p>107120 15</p>  <p>3/8-16 X 2</p>
<p>118241 25</p>  <p>5/16-18 NUT</p>	<p>118505 25</p>  <p>5/16 LOCKS</p>	<p>118525 25</p>  <p>5/16 FLATS</p>	<p>107062 20</p>  <p>5/16-18 X 1</p>	<p>107066 20</p>  <p>5/16-18 X 1-1/2</p>	<p>107070 20</p>  <p>5/16-18 X 2</p>
<p>118240 25</p>  <p>1/4-20 NUT</p>	<p>118504 25</p>  <p>1/4 LOCKS</p>	<p>118524 25</p>  <p>1/4 FLATS</p>	<p>107010 20</p>  <p>1/4-20 X 3/4</p>	<p>107012 20</p>  <p>1/4-20 X 1</p>	<p>107016 20</p>  <p>1/4-20 X 1-1/2</p>

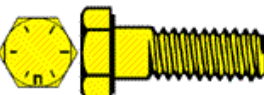
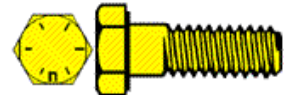
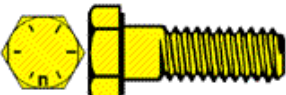
PART # 107-27

**ASSORTMENT: USS BOLTS GRADE 8**

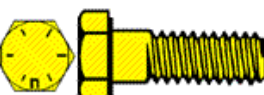
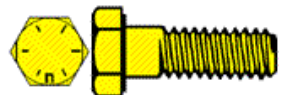
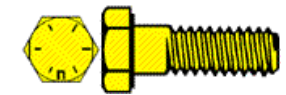







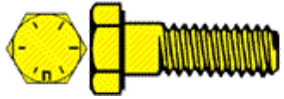
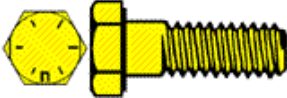
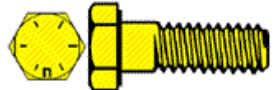
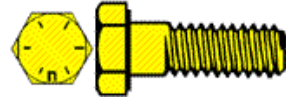
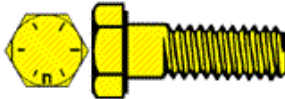

01/22

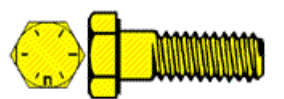
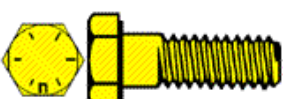
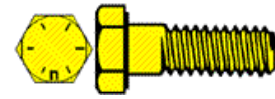
<p>118-244 25</p>  <p>1/2-13 NUT</p>	<p>107-212 25</p>  <p>1/2-13 X 1</p>	<p>107-214 25</p>  <p>1/2-13 X 1-1/4</p>	<p>107-216 10</p>  <p>1/2-13 X 1-1/2</p>	<p>107-218 10</p>  <p>1/2-13 X 1-3/4</p>	<p>107-220 10</p>  <p>1/2-13 X 2</p>
<p>118-242 25</p>  <p>3/8-16 NUT</p>	<p>107-112 25</p>  <p>3/8-16 X 1</p>	<p>107-114 25</p>  <p>3/8-16 X 1-1/4</p>	<p>107-116 15</p>  <p>3/8-16 X 1-1/2</p>	<p>107-118 15</p>  <p>3/8-16 X 1-3/4</p>	<p>107-120 15</p>  <p>3/8-16 X 2</p>
<p>118-241 25</p>  <p>5/16-18 NUT</p>	<p>107-060 25</p>  <p>5/16-18 X 3/4</p>	<p>107-062 25</p>  <p>5/16-18 X 1</p>	<p>107-064 20</p>  <p>5/16-18 X 1-1/4</p>	<p>107-066 20</p>  <p>5/16-18 X 1-1/2</p>	<p>107-070 20</p>  <p>5/16-18 X 2</p>
<p>118-240 25</p>  <p>1/4-20 NUT</p>	<p>107-010 25</p>  <p>1/4-20 X 3/4</p>	<p>107-012 25</p>  <p>1/4-20 X 1</p>	<p>107-014 20</p>  <p>1/4-20 X 1-1/4</p>	<p>107-016 20</p>  <p>1/4-20 X 1-1/2</p>	<p>107-020 20</p>  <p>1/4-20 X 2</p>

**PART # 107-28**

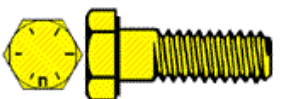
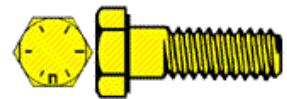
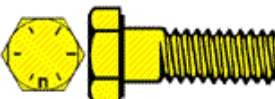
**ASSORTMENT: USS BOLTS GRADE 8**

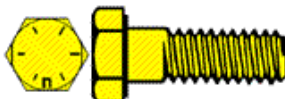
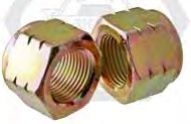
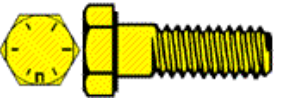
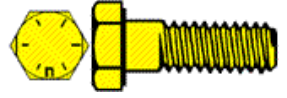
01/22

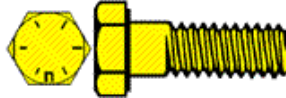
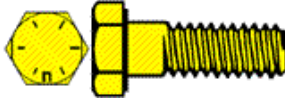
<p>118-914 25</p>  <p>1/2-13 NUT</p>	<p>107-212 25</p>  <p>1/2-13 X 1</p>	<p>107-214 25</p>  <p>1/2-13 X 1-1/4</p>	<p>107-216 10</p>  <p>1/2-13 X 1-1/2</p>	<p>107-218 10</p>  <p>1/2-13 X 1-3/4</p>	<p>107-220 10</p>  <p>1/2-13 X 2</p>
<p>118-912 25</p>  <p>3/8-16 NUT</p>	<p>107-112 25</p>  <p>3/8-16 X 1</p>	<p>107-114 25</p>  <p>3/8-16 X 1-1/4</p>	<p>107-116 15</p>  <p>3/8-16 X 1-1/2</p>	<p>107-118 15</p>  <p>3/8-16 X 1-3/4</p>	<p>107-120 15</p>  <p>3/8-16 X 2</p>
<p>118-911 25</p>  <p>5/16-18 NUT</p>	<p>107-060 25</p>  <p>5/16-18 X 3/4</p>	<p>107-062 25</p>  <p>5/16-18 X 1</p>	<p>107-064 20</p>  <p>5/16-18 X 1-1/4</p>	<p>107-066 20</p>  <p>5/16-18 X 1-1/2</p>	<p>107-070 20</p>  <p>5/16-18 X 2</p>
<p>118-910 25</p>  <p>1/4-20 NUT</p>	<p>107-010 25</p>  <p>1/4-20 X 3/4</p>	<p>107-012 25</p>  <p>1/4-20 X 1</p>	<p>107-014 20</p>  <p>1/4-20 X 1-1/4</p>	<p>107-016 20</p>  <p>1/4-20 X 1-1/2</p>	<p>107-020 20</p>  <p>1/4-20 X 2</p>

PART # 0107-30

# ASSORTMENT: USS BOLTS GRADE 8

01/22

107316

10

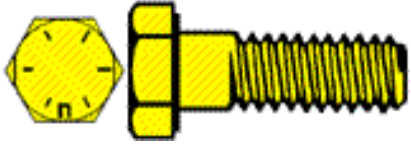

5/8-11 X 1-1/2

107324

10

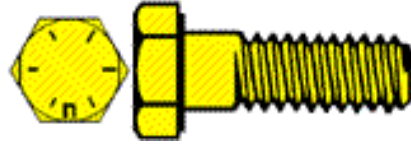

5/8-11 X 2-1/2

107368

10

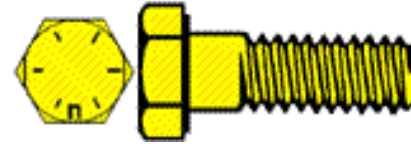

3/4-10 X 1-3/4

107314

10

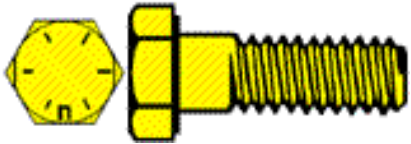

5/8-11 X 1-1/4

107320

10

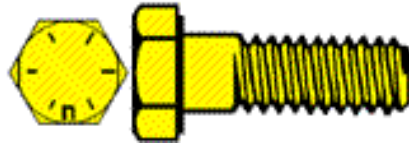

5/8-11 X 2

107366

10

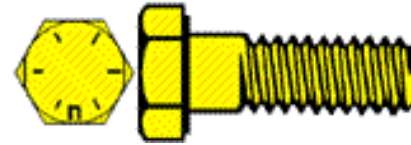

3/4-10 X 1-1/2

107374

10

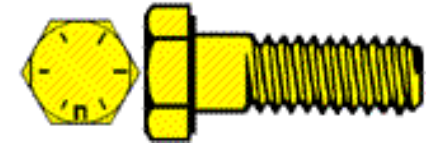

3/4-10 X 2-1/2

118246

10



5/8-11 NUTS

107318

10

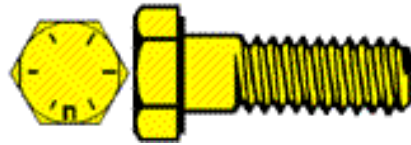

5/8-11 X 1-3/4

118247

10



3/4-10 NUTS

107370

10

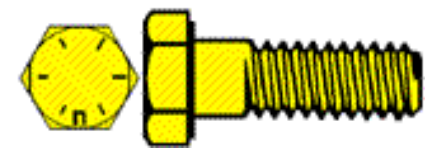

3/4-10 X 2

PART # 0107-35

**ASSORTMENT: USS BOLTS GRADE 8**

01/22

107318

10

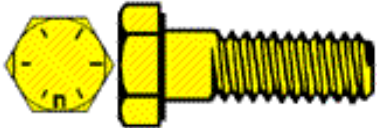

5/8-11 X 1-3/4

107328

10

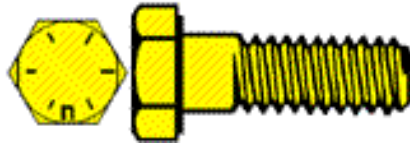

5/8-11 X 3

107368

10

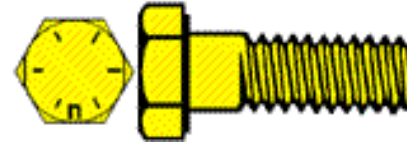

3/4-10 X 1-3/4

107378

10

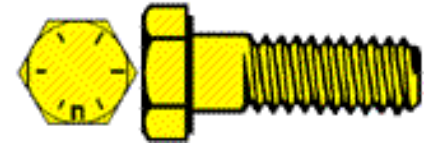

3/4-10 X 3

107316

10

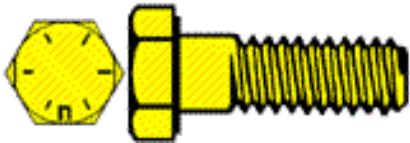

5/8-11 X 1-1/2

107324

10

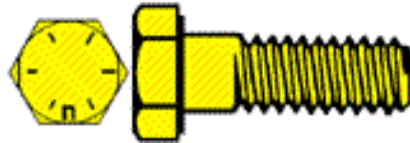

5/8-11 X 2-1/2

107366

10

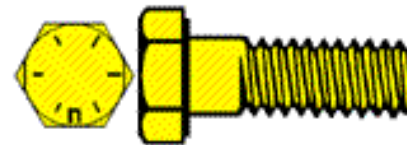

3/4-10 X 1-1/2

107374

10

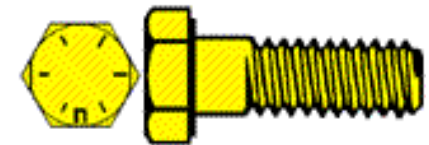

3/4-10 X 2-1/2

107314

10

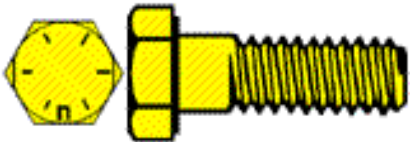

5/8-11 X 1-1/4

107320

10

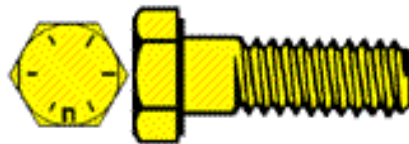

5/8-11 X 2

118247

10



3/4-10 NUTS

107370

10

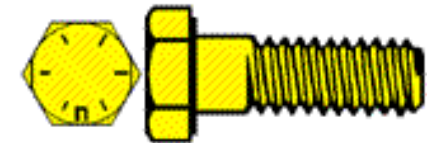

3/4-10 X 2

118246

10











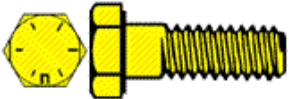
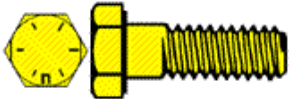
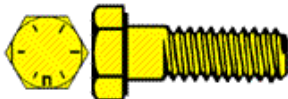
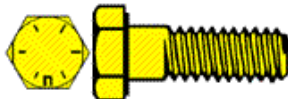
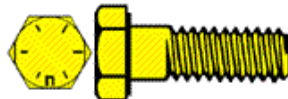

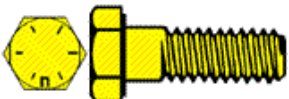
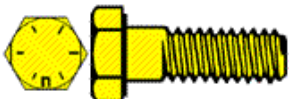

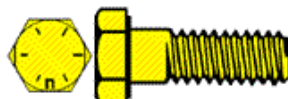

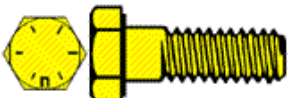
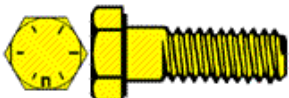
5/8-11 NUTS

PART # 0107-32

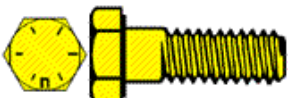
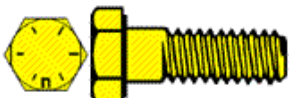
**ASSORTMENT: SAE BOLTS GRADE 8**













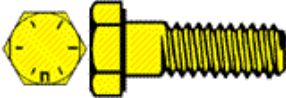

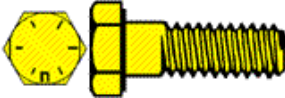

01/22

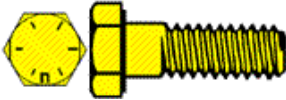
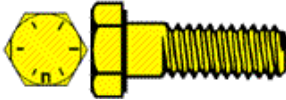
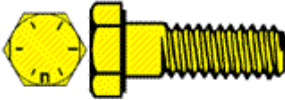
<p>118264 25</p>  <p>1/2-20 NUT</p>	<p>107712 10</p>  <p>1/2-20 X 1</p>	<p>107714 10</p>  <p>1/2-20 X 1-1/4</p>	<p>107716 10</p>  <p>1/2-20 X 1-1/2</p>	<p>107720 10</p>  <p>1/2-20 X 2</p>	<p>107724 10</p>  <p>1/2-20 X 2-1/2</p>
<p>118262 25</p>  <p>3/8-24 NUT</p>	<p>107610 15</p>  <p>3/8-24 X 3/4</p>	<p>107612 15</p>  <p>3/8-24 X 1</p>	<p>107614 15</p>  <p>3/8-24 X 1-1/4</p>	<p>107616 15</p>  <p>3/8-24 X 1-1/2</p>	<p>107620 15</p>  <p>3/8-24 X 2</p>
<p>118261 25</p>  <p>5/16-24 NUT</p>	<p>107560 20</p>  <p>5/16-24 X 3/4</p>	<p>107566 20</p>  <p>5/16-24 X 1</p>	<p>107564 20</p>  <p>5/16-24 X 1-1/4</p>	<p>107566 20</p>  <p>5/16-24 X 1-1/2</p>	<p>107570 20</p>  <p>5/16-24 X 2</p>
<p>118260 25</p>  <p>1/4-28 NUT</p>	<p>107510 20</p>  <p>1/4-28 X 3/4</p>	<p>107512 20</p>  <p>1/4-28 X 1</p>	<p>107514 20</p>  <p>1/4-28 X 1-1/4</p>	<p>107516 20</p>  <p>1/4-28 X 1-1/2</p>	<p>107520 20</p>  <p>1/4-28 X 2</p>

PART # 0107-35

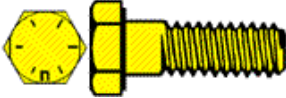
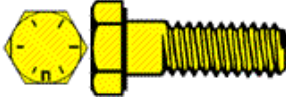
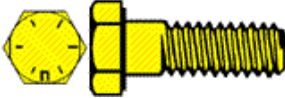
**ASSORTMENT: SAE BOLTS GRADE 8**

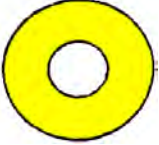
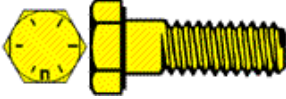





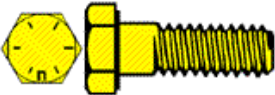
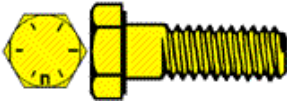
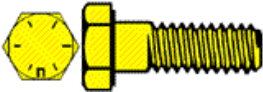
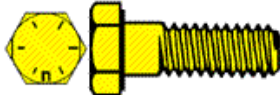

01/22

<p>118264 25</p>  <p>1/2-20 NUT</p>	<p>118508 25</p>  <p>1/2 LOCKS</p>	<p>118548 25</p>  <p>1/2 FLATS</p>	<p>107712 10</p>  <p>1/2-20 X 1</p>	<p>107716 10</p>  <p>1/2-20 X 1-1/2</p>	<p>107720 10</p>  <p>1/2-20 X 2</p>
<p>118262 25</p>  <p>3/8-24 NUT</p>	<p>118506 25</p>  <p>3/8 LOCKS</p>	<p>118546 25</p>  <p>3/8 FLATS</p>	<p>107612 15</p>  <p>3/8-24 X 1</p>	<p>107616 15</p>  <p>3/8-24 X 1-1/2</p>	<p>107620 15</p>  <p>3/8-24 X 2</p>
<p>118261 25</p>  <p>5/16-24 NUT</p>	<p>118505 25</p>  <p>5/16 LOCKS</p>	<p>118545 25</p>  <p>5/16 FLATS</p>	<p>107562 20</p>  <p>5/16-24 X 1</p>	<p>107566 20</p>  <p>5/16-24 X 1-1/2</p>	<p>107570 20</p>  <p>5/16-24 X 2</p>
<p>118260 25</p>  <p>1/4-28 NUT</p>	<p>118504 25</p>  <p>1/4 LOCKS</p>	<p>118544 25</p>  <p>1/4 FLATS</p>	<p>107510 20</p>  <p>1/4-28 X 3/4</p>	<p>107512 20</p>  <p>1/4-28 X 1</p>	<p>107516 20</p>  <p>1/4-28 X 1-1/2</p>

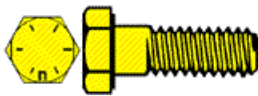
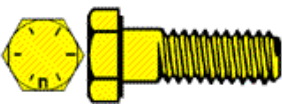
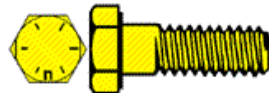
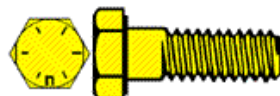
PART # 0107-36

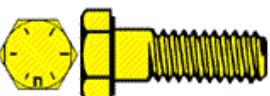
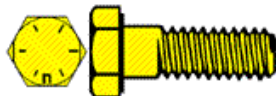
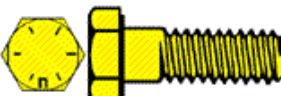
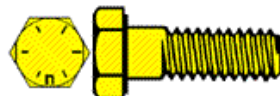
**ASSORTMENT: SAE BOLTS GRADE 8**

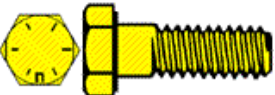
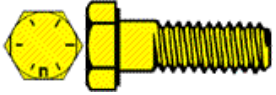
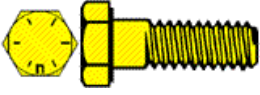

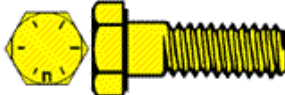



01/22

<p>118264 25</p>  <p>1/2-20 NUT</p>	<p>107-712 25</p>  <p>1/2-20 X 1</p>	<p>107-714 25</p>  <p>1/2-20 X 1-1/4</p>	<p>107-716 10</p>  <p>1/2-20 X 1-1/2</p>	<p>107-718 10</p>  <p>1/2-20 X 1-3/4</p>	<p>107-720 10</p>  <p>1/2-20 X 2</p>
<p>118262 25</p>  <p>3/8-24 NUT</p>	<p>107-612 25</p>  <p>3/8-24 X 1</p>	<p>107-614 25</p>  <p>3/8-24 X 1-1/4</p>	<p>107-616 15</p>  <p>3/8-24 X 1-1/2</p>	<p>107-618 15</p>  <p>3/8-24 X 1-3/4</p>	<p>107-620 15</p>  <p>3/8-24 X 2</p>
<p>118261 25</p>  <p>5/16-24 NUT</p>	<p>107-560 25</p>  <p>5/16-24 X 3/4</p>	<p>107-562 25</p>  <p>5/16-24 X 1</p>	<p>107-564 20</p>  <p>5/16-24 X 1-1/4</p>	<p>107-566 20</p>  <p>5/16-24 X 1-1/2</p>	<p>107-570 20</p>  <p>5/16-24 X 2</p>
<p>118260 25</p>  <p>1/4-28 NUT</p>	<p>107-510 25</p>  <p>1/4-28 X 3/4</p>	<p>107-512 25</p>  <p>1/4-28 X 1</p>	<p>107-514 20</p>  <p>1/4-28 X 1-1/4</p>	<p>107-516 20</p>  <p>1/4-28 X 1-1/2</p>	<p>107-520 20</p>  <p>1/4-28 X 2</p>

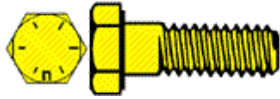
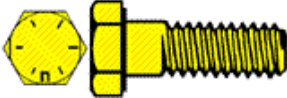
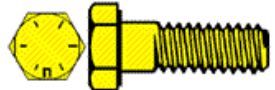
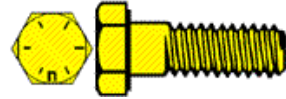
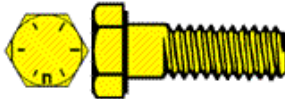
PART # CUSTOM

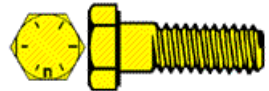
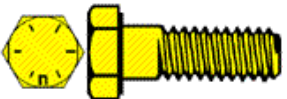
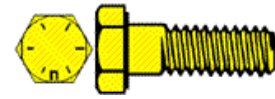
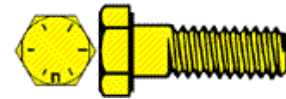
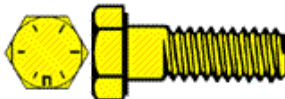
**ASSORTMENT: SAE BOLTS GRADE 8**

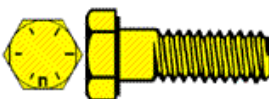
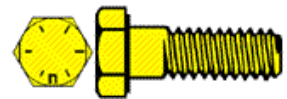
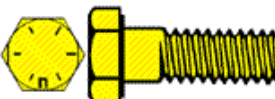
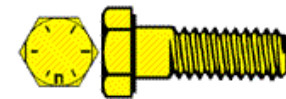
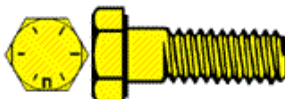
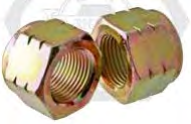
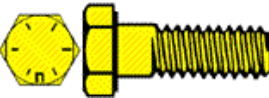
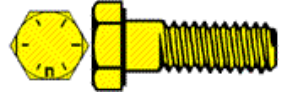
01/22

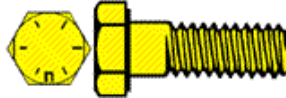
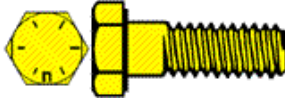
<p>118-944 25</p>  <p>1/2-20 NUT</p>	<p>107-712 25</p>  <p>1/2-20 X 1</p>	<p>107-714 25</p>  <p>1/2-20 X 1-1/4</p>	<p>107-716 10</p>  <p>1/2-20 X 1-1/2</p>	<p>107-718 10</p>  <p>1/2-20 X 1-3/4</p>	<p>107-720 10</p>  <p>1/2-20 X 2</p>
<p>118-942 25</p>  <p>3/8-24 NUT</p>	<p>107-612 25</p>  <p>3/8-24 X 1</p>	<p>107-614 25</p>  <p>3/8-24 X 1-1/4</p>	<p>107-616 15</p>  <p>3/8-24 X 1-1/2</p>	<p>107-618 15</p>  <p>3/8-24 X 1-3/4</p>	<p>107-620 15</p>  <p>3/8-24 X 2</p>
<p>118-941 25</p>  <p>5/16-24 NUT</p>	<p>107-560 25</p>  <p>5/16-24 X 3/4</p>	<p>107-562 25</p>  <p>5/16-24 X 1</p>	<p>107-564 20</p>  <p>5/16-24 X 1-1/4</p>	<p>107-566 20</p>  <p>5/16-24 X 1-1/2</p>	<p>107-570 20</p>  <p>5/16-24 X 2</p>
<p>118-940 25</p>  <p>1/4-28 NUT</p>	<p>107-510 25</p>  <p>1/4-28 X 3/4</p>	<p>107-512 25</p>  <p>1/4-28 X 1</p>	<p>107-514 20</p>  <p>1/4-28 X 1-1/4</p>	<p>107-516 20</p>  <p>1/4-28 X 1-1/2</p>	<p>107-520 20</p>  <p>1/4-28 X 2</p>

PART # 0107-40

# ASSORTMENT: SAE BOLTS GRADE 8

01/22

107816

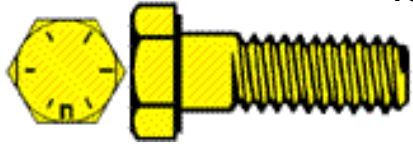

10

5/8-18 X 1-1/2

107824

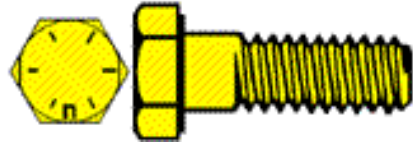

10

5/8-18 X 2-1/2

107868

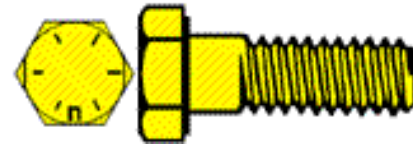

10

3/4-16 X 1-3/4

107814

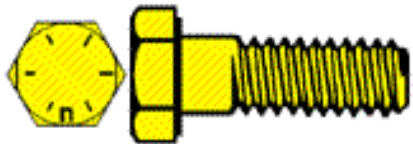

10

5/8-18 X 1-1/4

107820

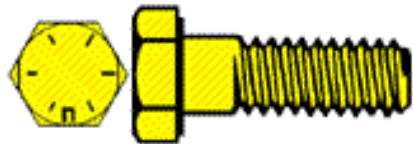

10

5/8-18 X 2

107866

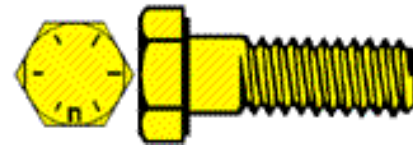

10

3/4-16 X 1-1/2

107874

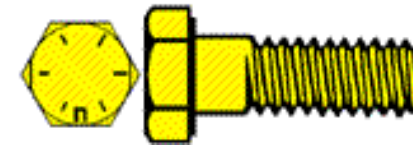

10

3/4-16 X 2-1/2

118266



10

5/8-18 NUTS

107818

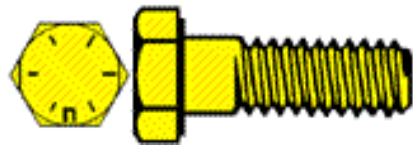

10

5/8-18 X 1-3/4

118267



10

3/4-16 NUTS



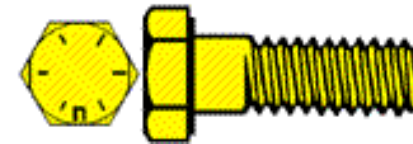































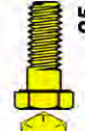

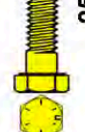











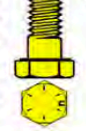







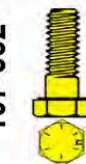













107870





































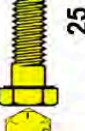







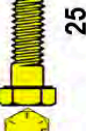





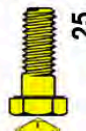
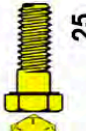

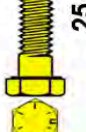



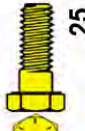
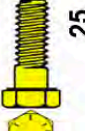

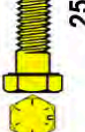



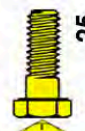
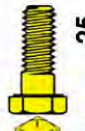

10

3/4-16 X 2

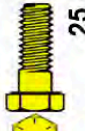
**PART # 0107-42**

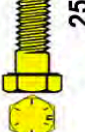
118-240	 100	1/4-20 NUT	118-241	 100	5/16-18 NUT	118-242	 100	3/8-16 NUT	118-243	 50	7/16-14 NUT	118-244	 50	1/2-13 NUT	118-246	 25	5/8-11 NUT	118-247	 20	3/4-10 NUT	107-124	 25	3/8-16 X 2-1/2
118-524	 100	1/4 FLATS	118-525	 100	5/16 FLATS	118-526	 100	3/8 FLATS	118-527	 50	7/16 FLATS	118-528	 50	1/2 FLATS	118-530	 25	5/8 FLATS	118-531	 20	3/4 FLATS	107-128	 25	3/8-16 X 3
118-504	 200	1/4 LOCKS	118-505	 200	5/16 LOCKS	118-506	 100	3/8 LOCKS	118-507	 100	7/16 LOCKS	118-508	 50	1/2 LOCKS	118-510	 50	5/8 LOCKS	118-511	 25	3/4 LOCKS	107-178	 10	7/16-14 X 3
107-008	 25	1/4-20 X 1/2	107-060	 25	5/16-18 X 3/4	107-110	 25	3/8-16 X 3/4	107-162	 25	7/16-14 X 1	107-212	 25	1/2-13 X 1	107-314	 10	5/8-11 X 1-1/4	107-364	 5	3/4-10 X 1-1/4	107-228	 10	1/2-13 X 3
107-010	 25	1/4-20 X 3/4	107-062	 25	5/16-18 X 1	107-112	 25	3/8-16 X 1	107-164	 25	7/16-14 X 1-1/4	107-214	 25	1/2-13 X 1-1/4	107-316	 10	5/8-11 X 1-1/2	107-366	 5	3/4-10 X 1-1/2	107-328	 5	5/8-11 X 3
107-012	 25	1/4-20 X 1	107-064	 25	5/16-18 X 1-1/4	107-114	 25	3/8-16 X 1-1/4	107-166	 25	7/16-14 X 1-1/2	107-216	 25	1/2-13 X 1-1/2	107-318	 10	5/8-11 X 1-3/4	107-370	 5	3/4-10 X 2	107-332	 5	5/8-11 X 3-1/2
107-014	 25	1/4-20 X 1-1/4	107-066	 25	5/16-18 X 1-1/2	107-116	 25	3/8-16 X 1-1/2	107-168	 25	7/16-14 X 1-3/4	107-218	 25	1/2-13 X 1-3/4	107-320	 10	5/8-11 X 2	107-374	 5	3/4-10 X 2-1/2	107-336	 5	5/8-11 X 4
107-016	 25	1/4-20 X 1-1/2	107-070	 25	5/16-18 X 2	107-120	 25	3/8-16 X 2	107-170	 25	7/16-14 X 2	107-220	 25	1/2-13 X 2	107-322	 10	5/8-11 X 2-1/4	107-378	 5	3/4-10 X 3	107-386	 5	3/4-10 X 4
107-020	 25	1/4-20 X 2	107-074	 25	5/16-18 X 2-1/2	107-122	 25	3/8-16 X 2-1/4	107-174	 25	7/16-14 X 2-1/2	107-224	 25	1/2-13 X 2-1/2	107-324	 10	5/8-11 X 2-1/2	107-382	 5	3/4-10 X 3-1/2			













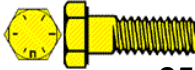
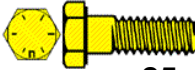

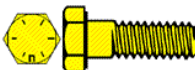
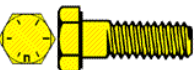



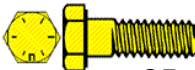
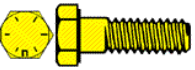
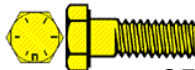
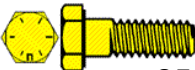





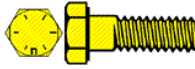



# PART # 0107-43

118-240	 100	1/4-20 NUT	118-241	 100	5/16-18 NUT	118-242	 100	3/8-16 NUT	118-243	 50	7/16-14 NUT	118-244	 50	1/2-13 NUT	118-246	 25	5/8-11 NUT	118-247	 20	3/4-10 NUT	107-124	 25	3/8-16 X 2-1/2
118-524	 100	1/4 FLATS	118-525	 100	5/16 FLATS	118-526	 100	3/8 FLATS	118-527	 50	7/16 FLATS	118-528	 50	1/2 FLATS	118-530	 25	5/8 FLATS	118-531	 20	3/4 FLATS	107-128	 25	3/8-16 X 3
118-504	 200	1/4 LOCKS	118-505	 200	5/16 LOCKS	118-506	 100	3/8 LOCKS	118-507	 100	7/16 LOCKS	118-508	 50	1/2 LOCKS	118-510	 50	5/8 LOCKS	118-511	 25	3/4 LOCKS	107-178	 10	7/16-14 X 3
107-008	 25	1/4-20 X 1/2	107-060	 25	5/16-18 X 3/4	107-110	 25	3/8-16 X 3/4	107-162	 25	7/16-14 X 1	107-212	 25	1/2-13 X 1	107-314	 10	5/8-11 X 1-1/4	107-364	 5	3/4-10 X 1-1/4	107-228	 10	1/2-13 X 3
107-010	 25	1/4-20 X 3/4	107-062	 25	5/16-18 X 1	107-112	 25	3/8-16 X 1	107-164	 25	7/16-14 X 1-1/4	107-214	 25	1/2-13 X 1-1/4	107-316	 10	5/8-11 X 1-1/2	107-366	 5	3/4-10 X 1-1/2	107-328	 5	5/8-11 X 3
107-012	 25	1/4-20 X 1	107-064	 25	5/16-18 X 1-1/4	107-114	 25	3/8-16 X 1-1/4	107-166	 25	7/16-14 X 1-1/2	107-216	 25	1/2-13 X 1-1/2	107-318	 10	5/8-11 X 1-3/4	107-370	 5	3/4-10 X 2	107-332	 5	5/8-11 X 3-1/2
107-014	 25	1/4-20 X 1-1/4	107-066	 25	5/16-18 X 1-1/2	107-116	 25	3/8-16 X 1-1/2	107-168	 25	7/16-14 X 1-3/4	107-218	 25	1/2-13 X 1-3/4	107-320	 10	5/8-11 X 2	107-374	 5	3/4-10 X 2-1/2	107-336	 5	5/8-11 X 4
107-016	 25	1/4-20 X 1-1/2	107-070	 25	5/16-18 X 2	107-120	 25	3/8-16 X 2	107-170	 25	7/16-14 X 2	107-220	 25	1/2-13 X 2	107-322	 10	5/8-11 X 2-1/4	107-378	 5	3/4-10 X 3	107-386	 5	3/4-10 X 4
107-020	 25	1/4-20 X 2	107-074	 25	5/16-18 X 2-1/2	107-122	 25	3/8-16 X 2-1/4	107-174	 25	7/16-14 X 2-1/2	107-224	 25	1/2-13 X 2-1/2	107-324	 10	5/8-11 X 2-1/2	107-382	 5	3/4-10 X 3-1/2			

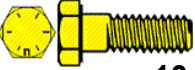
PART # 0107-45

**ASSORTMENT: USS BOLTS GRADE 8**

01/22

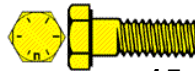
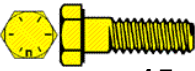
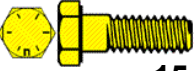
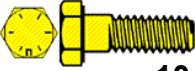











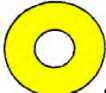









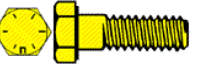





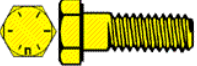

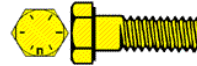



<p><b>118-240</b></p>  <p>100 1/4-20 NUT</p>	<p><b>118-504</b></p>  <p>200 1/4 LOCKS</p>	<p><b>118-524</b></p>  <p>100 1/4 FLATS</p>	<p><b>107-008</b></p>  <p>25 1/4-20 X 1/2</p>	<p><b>107-010</b></p>  <p>25 1/4-20 X 3/4</p>	<p><b>107-012</b></p>  <p>25 1/4-20 X 1</p>	<p><b>107-014</b></p>  <p>25 1/4-20 X 1-1/4</p>	<p><b>107-016</b></p>  <p>25 1/4-20 X 1-1/2</p>
<p><b>118-241</b></p>  <p>100 5/16-18 NUT</p>	<p><b>118-505</b></p>  <p>200 5/16 LOCKS</p>	<p><b>118-525</b></p>  <p>100 5/16 FLATS</p>	<p><b>107-060</b></p>  <p>25 5/16-18 X 3/4</p>	<p><b>107-062</b></p>  <p>25 5/16-18 X 1</p>	<p><b>107-064</b></p>  <p>25 5/16-18 X 1-1/4</p>	<p><b>107-066</b></p>  <p>25 5/16-18 X 1-1/2</p>	<p><b>107-070</b></p>  <p>25 5/16-18 X 2</p>
<p><b>118-242</b></p>  <p>100 3/8-16 NUT</p>	<p><b>118-506</b></p>  <p>100 3/8 LOCKS</p>	<p><b>118-526</b></p>  <p>100 3/8 FLATS</p>	<p><b>107-110</b></p>  <p>25 3/8-16 X 3/4</p>	<p><b>107-112</b></p>  <p>25 3/8-16 X 1</p>	<p><b>107-114</b></p>  <p>25 3/8-16 X 1-1/4</p>	<p><b>107-116</b></p>  <p>25 3/8-16 X 1-1/2</p>	<p><b>107-120</b></p>  <p>25 3/8-16 X 2</p>
<p><b>118-243</b></p>  <p>50 7/16-14 NUT</p>	<p><b>118-507</b></p>  <p>50 7/16 LOCKS</p>	<p><b>118-527</b></p>  <p>50 7/16 FLATS</p>	<p><b>107-162</b></p>  <p>15 7/16-14 X 1</p>	<p><b>107-166</b></p>  <p>15 7/16-14 X 1-1/2</p>	<p><b>107-170</b></p>  <p>15 7/16-14 X 2</p>	<p><b>107-228</b></p>  <p>10 1/2-13 X 3</p>	<p><b>107-224</b></p>  <p>10 1/2-13 X 2-1/2</p>
<p><b>118-244</b></p>  <p>50 1/2-13 NUT</p>	<p><b>118-508</b></p>  <p>50 1/2 LOCKS</p>	<p><b>118-528</b></p>  <p>50 1/2 FLATS</p>	<p><b>107-214</b></p>  <p>15 1/2-13 X 1-1/4</p>	<p><b>107-216</b></p>  <p>15 1/3-13 X 1-1/2</p>	<p><b>107-218</b></p>  <p>15 1/2-13 X 1-3/4</p>	<p><b>107-220</b></p>  <p>15 1/2-13 X 2</p>	<p><b>107-222</b></p>  <p>10 1/2-13 X 2-1/4</p>

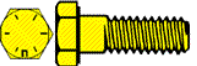
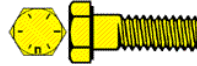
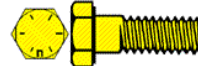

PART # 0107-50

**ASSORTMENT: SAE BOLTS GRADE 8**

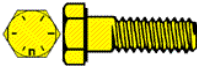
01/22













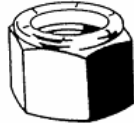

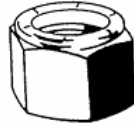
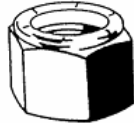
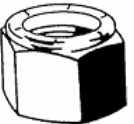
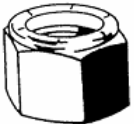
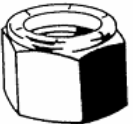
<p><b>118-260</b></p>  <p>100</p> <p>1/4-28 NUT</p>	<p><b>118-504</b></p>  <p>200</p> <p>1/4 LOCKS</p>	<p><b>118-544</b></p>  <p>100</p> <p>1/4 FLATS</p>	<p><b>107-506</b></p>  <p>25</p> <p>1/4-28 X 1/2</p>	<p><b>107-510</b></p>  <p>25</p> <p>1/4-28 X 3/4</p>	<p><b>107-512</b></p>  <p>25</p> <p>1/4-28 X 1</p>	<p><b>107-514</b></p>  <p>25</p> <p>1/4-28 X 1-1/4</p>	<p><b>107-516</b></p>  <p>25</p> <p>1/4-28 X 1-1/2</p>
<p><b>118-261</b></p>  <p>100</p> <p>5/16-24 NUT</p>	<p><b>118-505</b></p>  <p>200</p> <p>5/16 LOCKS</p>	<p><b>118-545</b></p>  <p>100</p> <p>5/16 FLATS</p>	<p><b>107-560</b></p>  <p>25</p> <p>5/16-24 X 3/4</p>	<p><b>107-562</b></p>  <p>25</p> <p>5/16-24 X 1</p>	<p><b>107-564</b></p>  <p>25</p> <p>5/16-24 X 1-1/4</p>	<p><b>107566</b></p>  <p>25</p> <p>5/16-24 X 1-1/2</p>	<p><b>107-570</b></p>  <p>25</p> <p>5/16-24 X 2</p>
<p><b>118-262</b></p>  <p>100</p> <p>3/8-24 NUT</p>	<p><b>118-506</b></p>  <p>100</p> <p>3/8 LOCKS</p>	<p><b>118-546</b></p>  <p>100</p> <p>3/8 FLATS</p>	<p><b>107-610</b></p>  <p>25</p> <p>3/8-24 X 3/4</p>	<p><b>107-612</b></p>  <p>25</p> <p>3/8-24 X 1</p>	<p><b>107-614</b></p>  <p>25</p> <p>3/8-24 X 1-1/4</p>	<p><b>107-616</b></p>  <p>25</p> <p>3/8-24 X 1-1/2</p>	<p><b>107-620</b></p>  <p>25</p> <p>3/8-24 X 2</p>
<p><b>118-263</b></p>  <p>50</p> <p>7/16-20 NUT</p>	<p><b>118-507</b></p>  <p>50</p> <p>7/16 LOCKS</p>	<p><b>118-547</b></p>  <p>50</p> <p>7/16 FLATS</p>	<p><b>107-662</b></p>  <p>15</p> <p>7/16-20 X 1</p>	<p><b>107-666</b></p>  <p>15</p> <p>7/16-20 X 1-1/2</p>	<p><b>107-670</b></p>  <p>15</p> <p>7/16-20 X 2</p>	<p><b>107-728</b></p>  <p>10</p> <p>1/3-20 X 3</p>	<p><b>107-724</b></p>  <p>10</p> <p>1/2-20 X 2-1/2</p>
<p><b>118-264</b></p>  <p>25</p> <p>1/2-20 NUT</p>	<p><b>118-508</b></p>  <p>50</p> <p>1/2 LOCKS</p>	<p><b>118-548</b></p>  <p>50</p> <p>1/2 FLATS</p>	<p><b>107-714</b></p>  <p>15</p> <p>1/2-20 X 1-1/4</p>	<p><b>107-716</b></p>  <p>15</p> <p>1/3-20 X 1-1/2</p>	<p><b>107-718</b></p>  <p>15</p> <p>1/2-20 X 1-3/4</p>	<p><b>107-720</b></p>  <p>15</p> <p>1/2-20 X 2</p>	<p><b>107-722</b></p>  <p>10</p> <p>1/2-20 X 2-1/4</p>

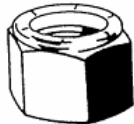

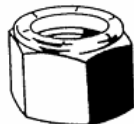
**PART # 0118-25**

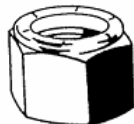
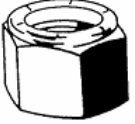
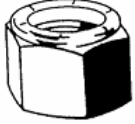





**ASSORTMENT: NYLON LOCK NUTS**

01/22

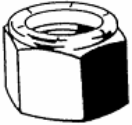
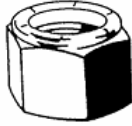
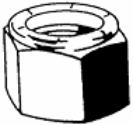
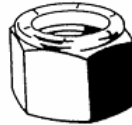
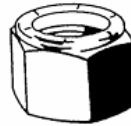
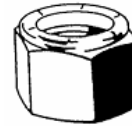
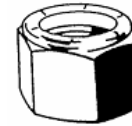
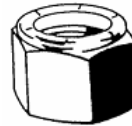
<p><b>118-322</b> 25</p>  <p><b>3/8-24 SAE</b></p>	<p><b>118-323</b> 25</p>  <p><b>7/16-20 SAE</b></p>	<p><b>118-324</b> 25</p>  <p><b>1/2-20 SAE</b></p>	<p><b>118-325</b> 10</p>  <p><b>9/16-18 SAE</b></p>	<p><b>118-326</b> 10</p>  <p><b>5/8-18 SAE</b></p>	<p><b>118-328</b> 5</p>  <p><b>7/8-14 SAE</b></p>
<p><b>121-120</b> 50</p>  <p><b>6-32</b></p>	<p><b>121-137</b> 50</p>  <p><b>12-24</b></p>	<p><b>118-320</b> 25</p>  <p><b>1/4-28 SAE</b></p>	<p><b>118-321</b> 25</p>  <p><b>5/16-24 SAE</b></p>	<p><b>10</b></p>	<p><b>118-327</b> 10</p>  <p><b>3/4-16 SAE</b></p>
<p><b>118-312</b> 25</p>  <p><b>3/8-16 USS</b></p>	<p><b>118-313</b> 25</p>  <p><b>7/16-14 USS</b></p>	<p><b>118-314</b> 25</p>  <p><b>1/2-13 USS</b></p>	<p><b>118-315</b> 10</p>  <p><b>9/16-12 USS</b></p>	<p><b>118-316</b> 10</p>  <p><b>5/8-11 USS</b></p>	<p><b>118-318</b> 5</p>  <p><b>7/8-9 USS</b></p>
<p><b>121-122</b> 50</p>  <p><b>8/32 USS</b></p>	<p><b>121-125</b> 50</p>  <p><b>10-24 USS</b></p>	<p><b>121-135</b> 25</p>  <p><b>10-32 USS</b></p>	<p><b>118-310</b> 25</p>  <p><b>1/4-20 USS</b></p>	<p><b>118-311</b> 25</p>  <p><b>5/16-18 USS</b></p>	<p><b>118-317</b> 10</p>  <p><b>3/4-10 USS</b></p>

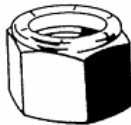
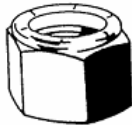
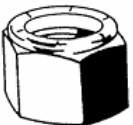
**PART # 0118-50 ASSORTMENT: GRADE 8 NYLON LOCK NUTS**



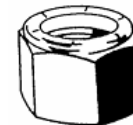
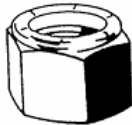



01/22

<p><b>118-945</b> 10</p>  <p><b>9/16-18 SAE</b></p>	<p><b>118-946</b> 10</p>  <p><b>5/8-18 SAE</b></p>				<p><b>118-948</b> 5</p>  <p><b>7/8-14 SAE</b></p>
<p><b>118-940</b> 25</p>  <p><b>1/4-28 SAE</b></p>	<p><b>118-941</b> 25</p>  <p><b>5/16-24 SAE</b></p>	<p><b>118-942</b> 25</p>  <p><b>3/8-24 SAE</b></p>	<p><b>118-943</b> 25</p>  <p><b>7/16-20 SAE</b></p>	<p><b>118-944</b> 25</p>  <p><b>1/2-20 SAE</b></p>	<p><b>118-947</b> 10</p>  <p><b>3/4-16 SAE</b></p>
<p><b>118-915</b> 10</p>  <p><b>9/16-12 USS</b></p>	<p><b>118-916</b> 10</p>  <p><b>5/8-11 USS</b></p>				<p><b>118-918</b> 5</p>  <p><b>7/8-9 USS</b></p>
<p><b>118-910</b> 25</p>  <p><b>1/4-20 USS</b></p>	<p><b>118-911</b> 25</p>  <p><b>5/16-18 USS</b></p>	<p><b>118-912</b> 25</p>  <p><b>3/8-16 USS</b></p>	<p><b>118-913</b> 25</p>  <p><b>7/16-14 USS</b></p>	<p><b>118-914</b> 25</p>  <p><b>1/2-13 USS</b></p>	<p><b>118-917</b> 10</p>  <p><b>3/4-10 USS</b></p>

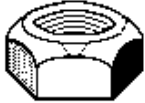
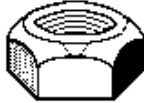
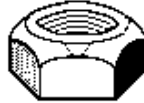
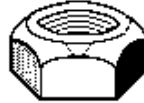
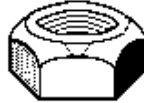
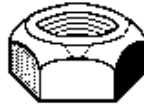
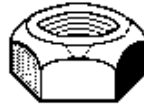
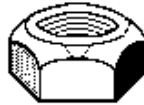
PART # 0118-35

**ASSORTMENT: STOVER LOCK NUTS**

01/22

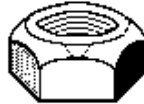
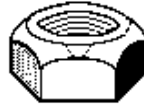
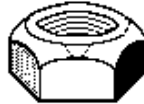
<p>118-342 25</p>  <p>3/8-24 SAE</p>	<p>118-343 25</p>  <p>7/16-20 SAE</p>	<p>118-344 25</p>  <p>1/2-20 SAE</p>	<p>118-345 10</p>  <p>9/16-18 SAE</p>	<p>118-346 10</p>  <p>5/8-18 SAE</p>	<p>118-348 5</p>  <p>7/8-14 SAE</p>
			<p>118-340 25</p>  <p>1/4-28 SAE</p>	<p>118-341 25</p>  <p>5/16-24 SAE</p>	<p>118-347 5</p>  <p>3/4-16 SAE</p>
<p>118-332 25</p>  <p>3/8-16 USS</p>	<p>118-333 25</p>  <p>7/16-14 USS</p>	<p>118-334 25</p>  <p>1/2-13 USS</p>	<p>118-335 10</p>  <p>9/16-12 USS</p>	<p>118-336 10</p>  <p>5/8-11 USS</p>	<p>118-338 5</p>  <p>7/8-9 USS</p>
			<p>118-330 25</p>  <p>1/4-20 USS</p>	<p>118-331 25</p>  <p>5/16-18 USS</p>	<p>118-337 5</p>  <p>3/4-10 USS</p>



**PART # 0118-40**

# ASSORTMENT: STOVER LOCK NUTS

01/22

**118-333**

25

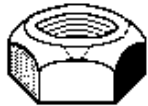

**7/16-14 USS**

**118-337**

5

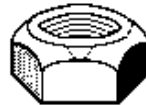

**3/4-10 USS**

**118-343**

25

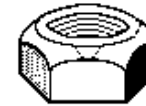

**7/16-20 SAE**

**118-347**

5



**3/4-16 SAE**

**118-332**

25



**3/8-16 USS**

**118-336**

5

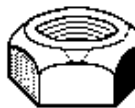

**3/8-24 SAE**

**118-346**

5

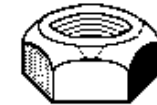

**5/8-18 SAE**

**118-331**

25



**5/16-18 USS**



**5/8-11 USS**

**118-341**

25

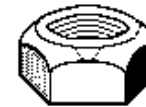

**5/16-24 SAE**

**118-344**

10

**118-330**

25



**1/4-20 USS**

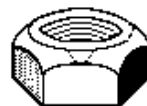

**1/2-13 USS**

**118-340**

25

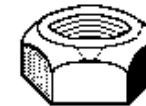

**1/4-28 SAE**

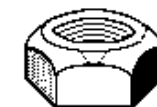

















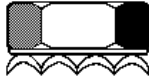
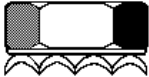
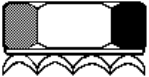
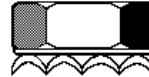

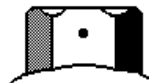
**1/2-20 SAE**



PART # 0120-25

**ASSORTMENT: KEEP / FLANGE NUTS**













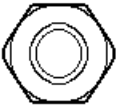
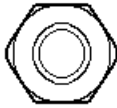



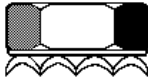

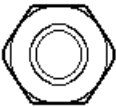

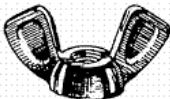

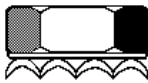



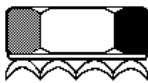

01/22

<p>120-208 25</p>  <p>6-32 SAE</p>	<p>120-210 25</p>  <p>8-32 SAE</p>	<p>120-214 25</p>  <p>10-32 SAE</p>	<p>120-260 25</p>  <p>1/4-28 SAE</p>	<p>120-261 25</p>  <p>5/16-24 SAE</p>	<p>120-262 20</p>  <p>5/16-24 SAE</p>
<p>120-212 25</p>  <p>10-24 USS</p>	<p>120-218 25</p>  <p>1/4-20 USS</p>	<p>120-220 25</p>  <p>5/16-18 USS</p>	<p>120-222 20</p>  <p>3/8-16 USS</p>		<p>122-018 5</p>  <p>3/4-10 USS</p>
<p>120-160 25</p>  <p>1/4-28 SAE</p>	<p>120-161 25</p>  <p>5/16-24 SAE</p>	<p>120-162 25</p>  <p>3/8-24 SAE</p>	<p>120-163 10</p>  <p>7/16-20 SAE</p>	<p>120-164 10</p>  <p>1/2-20 SAE</p>	<p>122-017 5</p>  <p>5/8-11 USS</p>
<p>120-116 25</p>  <p>10-24 USS</p>	<p>120-118 25</p>  <p>1/4-20 USS</p>	<p>120-120 25</p>  <p>5/16-18 USS</p>	<p>120-122 20</p>  <p>3/8-16 USS</p>	<p>120-123 20</p>  <p>7/16-14 USS</p>	<p>122-015 20</p>  <p>1/2-13 USS</p>

PART # 0121-25

**ASSORTMENT: SMALL NUTS & FLATS**



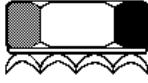





















01/22

<p>121-204 100</p>  <p>#6 FLATS</p>	<p>121-324 100</p>  <p>#6 LOCKS</p>	<p>121-004 100</p>  <p>4-40 NUTS</p>	<p>121-018 50</p>  <p>1/4-20 NUTS</p>	<p>120-118 50</p>  <p>1/4-20 FLG NUT</p>	<p>120-554 50</p>  <p>6-32 WING</p>	<p>121-120 50</p>  <p>6-32 NYLON</p>	<p>120-208 50</p>  <p>6-32 KEEP</p>
<p>121-205 100</p>  <p>#8 FLATS</p>	<p>121-325 100</p>  <p>#8 LOCKS</p>	<p>121-006 100</p>  <p>5-40 NUTS</p>	<p>121-016 50</p>  <p>12-24 NUTS</p>	<p>120-116 50</p>  <p>10-24 FLG NUT</p>	<p>120-556 50</p>  <p>8-32 WING</p>	<p>121-122 50</p>  <p>8-32 NYLON</p>	<p>120-210 50</p>  <p>8-32 KEEP</p>
<p>121-206 100</p>  <p>#10 FLATS</p>	<p>121-326 100</p>  <p>#10 LOCKS</p>	<p>121-008 100</p>  <p>6-32 NUTS</p>	<p>121-014 100</p>  <p>10-32 NUTS</p>	<p>120-158 50</p>  <p>8-32 FLG NUT</p>	<p>120-558 50</p>  <p>10-32 WING</p>	<p>121-125 50</p>  <p>10-24 NYLON</p>	<p>120-212 50</p>  <p>10-24 KEEP</p>
<p>121-207 100</p>  <p>#12 FLATS</p>	<p>121-327 100</p>  <p>#12 LOCKS</p>	<p>121-010 100</p>  <p>8-32 NUTS</p>	<p>121-012 100</p>  <p>10-24 NUTS</p>	<p>121-298 50</p>  <p>12-24 WING</p>	<p>120-560 50</p>  <p>10-24 WING</p>	<p>121-135 50</p>  <p>10-32 NYLON</p>	<p>120-214 50</p>  <p>10-32 KEEP</p>

PART # 0121-30

**ASSORTMENT: SHAKEPROOF WASHER**

01/22

<p>121-622 25</p>  <p>#10 COUNTER</p>	<p>121-576 25</p>  <p>5/16 INTERNAL</p>	<p>121-577 25</p>  <p>3/8 INTERNAL</p>	<p>121-578 20</p>  <p>7/16 INTERNAL</p>	<p>121-579 20</p>  <p>1/2 INTERNAL</p>	<p>121-582 5</p>  <p>3/4 INTERNAL</p>
<p>121-620 25</p>  <p>#8 COUNTER</p>	<p>121-572 25</p>  <p>#8 INTERNAL</p>	<p>121-573 25</p>  <p>#10 INTERNAL</p>	<p>121-574 25</p>  <p>#12 INTERNAL</p>	<p>121-575 25</p>  <p>1/4 INTERNAL</p>	<p>121-581 5</p>  <p>5/8 INTERNAL</p>
<p>121-619 25</p>  <p>#6 COUNTER</p>	<p>121-456 25</p>  <p>5/16 EXTERNAL</p>	<p>121-457 25</p>  <p>3/8 EXTERNAL</p>	<p>121-458 20</p>  <p>7/16 EXTERNAL</p>	<p>121-459 20</p>  <p>1/2 EXTERNAL</p>	<p>121-462 5</p>  <p>3/4 EXTERNAL</p>
<p>121-451 25</p>  <p>#6 EXTERNAL</p>	<p>121-452 25</p>  <p>#8 EXTERNAL</p>	<p>121-453 25</p>  <p>#10 EXTERNAL</p>	<p>121-454 25</p>  <p>#12 EXTERNAL</p>	<p>121-455 25</p>  <p>1/4 EXTERNAL</p>	<p>121-461 5</p>  <p>5/8 EXTERNAL</p>

**PART # 0121-45**

**ASSORTMENT: FENDER WASHERS**

01/22

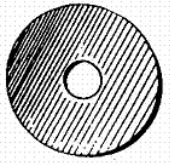
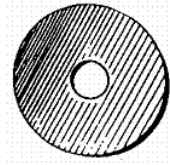
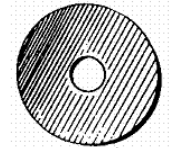
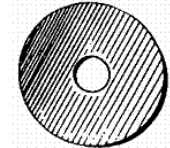
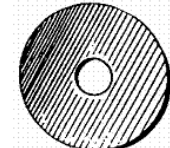
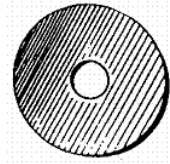
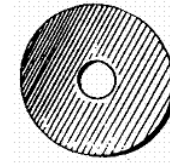
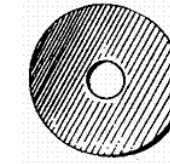
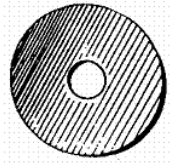
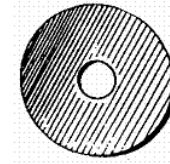
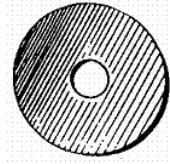
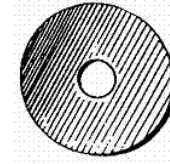
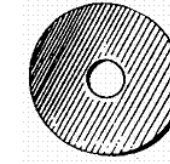
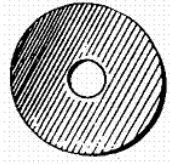
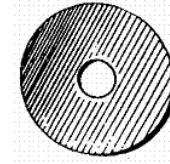
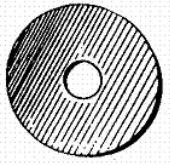
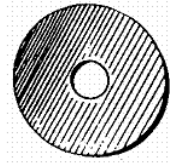
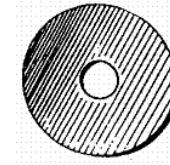
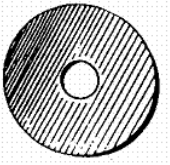
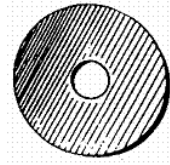
<p>121-829 25</p>  <p>1/2 X 1-3/4</p>	<p>121-830 25</p>  <p>1/2 X 2</p>	<p>121-854 25</p>  <p>HEAVY DUTY FENDER 1/4 X 1-1/4</p>	<p>121-859 25</p>  <p>HEAVY DUTY FENDER 5/16 X 1-1/2</p>	<p>121-862 25</p>  <p>HEAVY DUTY FENDER 3/8 X 1-1/2</p>
<p>121-823 25</p>  <p>3/8 X 1-1/4</p>	<p>121-824 25</p>  <p>3/8 X 1-1/2</p>	<p>121-825 25</p>  <p>3/8 X 1-3/4</p>	<p>121-826 25</p>  <p>3/8 X 2</p>	<p>121-828 25</p>  <p>1/2 X 1-1/2</p>
<p>121-812 25</p>  <p>1/4 X 1-1/2</p>	<p>121-814 25</p>  <p>1/4 X 2</p>	<p>121-818 25</p>  <p>5/16 X 1-1/4</p>	<p>121-820 25</p>  <p>5/16 X 1-1/2</p>	<p>121-822 25</p>  <p>5/16 X 2</p>
<p>121-804 25</p>  <p>3/16 X 3/4</p>	<p>121-806 25</p>  <p>3/16 X 1"</p>	<p>121-807 25</p>  <p>3/16 X 1-1/4</p>	<p>121-808 25</p>  <p>1/4 X 1</p>	<p>121-810 25</p>  <p>1/4 X 1-1/4</p>

PART # 0122-25

**ASSORTMENT: USS FLANGE BOLTS**

01/22



PART # 0122-35

# ASSORTMENT: SAE FLANGE BOLTS

01/22

**122-484**

10



5/8-18 X 2

**122-485**

10



5/8-18 X 2-1/4

**122-486**

10



5/8-18 X 2-1/2

**122-157**

10



5/8-18 NUT

**122-482**

10



5/8-18 X 1-1/2

**122-483**

10



5/8-18 X 1-3/4

**122-474**

10



1/2-20 X 2

**122-476**

10



1/2-20 X 2-1/2

**122-155**

10



1/2-20 NUT

**122-472**

10



1/2-20 X 1-1/2

**122-473**

10



1/2-20 X 1-3/4



PART # 0124-25 - 0124-37

**ASSORTMENT: 3' ALLTHREAD**

01/22

**GRADE 2 ALL THREAD  
ASSORTMENT**

**PART # 0124-25**

**USS GRADE-2 3' ALLTHREAD**



Part #	SIZE	QTY
124-160	10-24 G-2	1
124-161	10-32 G-2	1
124-166	1/4-20	2
124-167	5/16-18	2
124-168	3/8-16	2
124-169	7/16-14	2
124-170	1/2-13	2
124-171	9/16-12	1
124-172	5/8-11	1
124-173	3/4-10	1
124-174	7/8-9	1
124-175	1-8	1

**PART # 0124-27**

**USS GRADE-2 3' ALLTHREAD**

Part #	SIZE	QTY
124-182	1/4-28	2
124-183	5/16-24	2
124-184	3/8-24	2
124-185	7/16-20	2
124-186	1/2-20	2
124-187	9/16-18	1
124-188	5/8-18	1
124-189	3/4-16	1
124-190	7/8-14	1
124-191	1-14	1

**GRADE 8 ALL THREAD  
ASSORTMENT**

**PART # 0124-35**

**USS GRADE-8 3' ALLTHREAD**

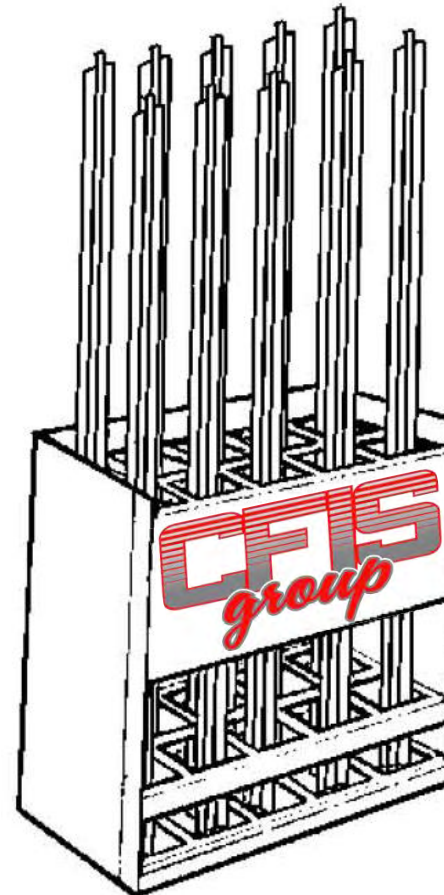

Part #	SIZE	QTY
124-160	10-24 G-2	1
124-161	10-32 G-2	1
124-847	1/4-20	2
124-848	5/16-18	2
124-849	3/8-16	2
124-850	7/16-14	2
124-851	1/2-13	2
124-852	9/16-12	1
124-853	5/8-11	1
124-854	3/4-10	1
124-855	7/8-9	1
124-856	1-8	1

**PART # 0124-37**









**SAE GRADE-8 3' ALLTHREAD**

Part #	SIZE	QTY
124-872	1/4-28	2
124-873	5/16-24	2
124-874	3/8-24	2
124-875	7/16-20	2
124-876	1/2-20	2
124-878	5/8-18	1
124-879	3/4-16	1
124-880	7/8-14	1
124-881	1-14	1

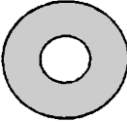
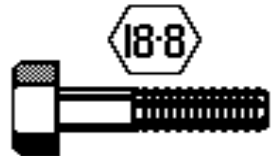
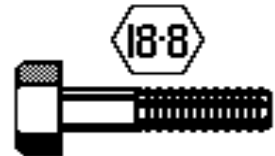
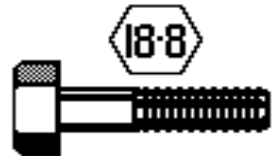
PART # 0125-25

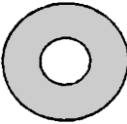
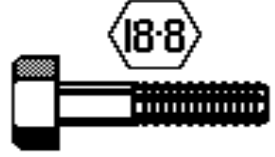
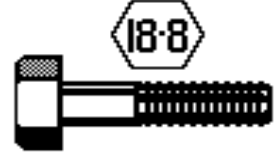
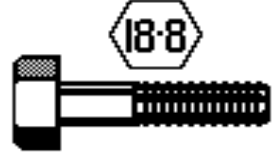
**ASSORTMENT: STAINLESS FASTENERS**

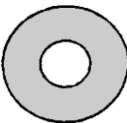
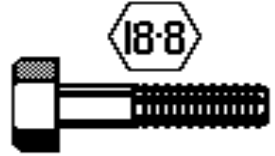
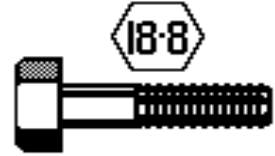
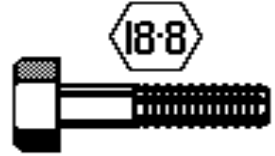

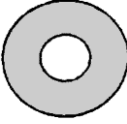
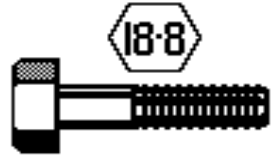
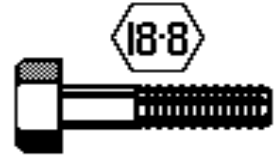
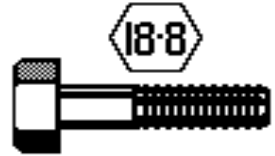



01/22

<p>125-010 10</p>  <p>1/2-13 NUT</p>	<p>125-064 25</p>  <p>1/2 LOCKS</p>	<p>125-050 25</p>  <p>1/2 FLATS</p>	<p>125-144 10</p>  <p>1/2-13 X 1</p>	<p>125-146 10</p>  <p>1/2-13 X 1-1/2</p>	<p>125-148 10</p>  <p>1/2-13 X 2</p>
<p>125-008 25</p>  <p>3/8-16 NUT</p>	<p>125-062 50</p>  <p>3/8 LOCKS</p>	<p>125-046 50</p>  <p>3/8 FLATS</p>	<p>125-116 10</p>  <p>3/8-16 X 1</p>	<p>125-117 10</p>  <p>3/8-16 X 1-1/4</p>	<p>125-118 10</p>  <p>3/8-16 X 1-1/2</p>
<p>125-007 25</p>  <p>5/16-18 NUT</p>	<p>125-061 50</p>  <p>5/16 LOCKS</p>	<p>125-042 50</p>  <p>5/16 FLATS</p>	<p>125-097 20</p>  <p>5/16-18 X 1</p>	<p>125-098 20</p>  <p>5/16-18 X 1-1/4</p>	<p>125-099 20</p>  <p>5/16 X 1-1/2</p>
<p>125-006 25</p>  <p>1/4-20 NUT</p>	<p>125-060 50</p>  <p>1/4 LOCKS</p>	<p>125-040 50</p>  <p>1/4 FLATS</p>	<p>125-073 20</p>  <p>1/4-20 X 3/4</p>	<p>125-074 20</p>  <p>1/4-20 X 1</p>	<p>125-075 20</p>  <p>1/4-20 X 1-1/4</p>

PART # 0125-30

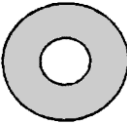
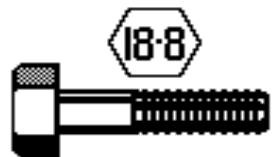
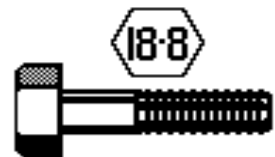
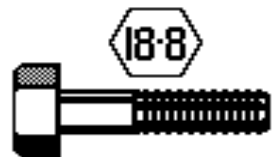
**ASSORTMENT: STAINLESS FASTENERS**

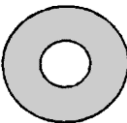
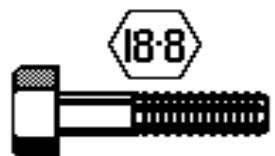
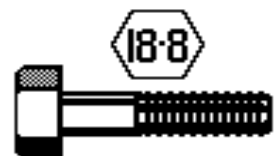
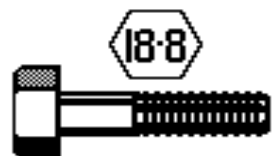

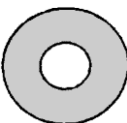
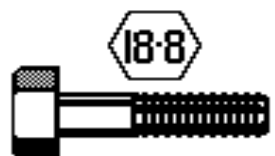
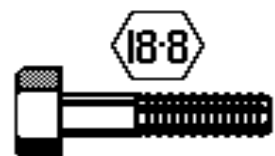
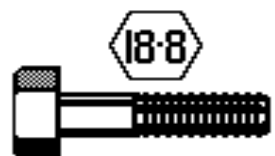























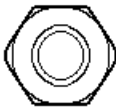
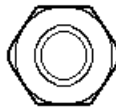
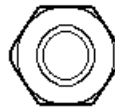

01/22

<p>125-008 25</p>  <p>3/8-16 NUT</p>	<p>125-062 50</p>  <p>3/8 LOCKS</p>	<p>125-045 50</p>  <p>3/8 FLATS</p>	<p>125-116 10</p>  <p>3/8-16 X 1</p>	<p>125-118 10</p>  <p>3/8-16 X 1-1/2</p>	<p>125-120 10</p>  <p>3/8-16 X 2</p>
<p>125-007 25</p>  <p>5/16-18 NUT</p>	<p>125-061 50</p>  <p>5/16 LOCKS</p>	<p>125-042 50</p>  <p>5/16 FLATS</p>	<p>125-097 20</p>  <p>5/16-18 X 1</p>	<p>125-099 20</p>  <p>5/16-18 X 1-1/2</p>	<p>125-101 20</p>  <p>5/16 X 2</p>
<p>125-006 25</p>  <p>1/4-20 NUT</p>	<p>125-060 50</p>  <p>1/4 LOCKS</p>	<p>125-040 50</p>  <p>1/4 FLATS</p>	<p>125-074 20</p>  <p>1/4-20 X 1</p>	<p>125-076 20</p>  <p>1/4-20 X 1-1/2</p>	<p>125-078 20</p>  <p>1/4-20 X 2</p>













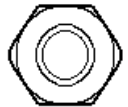
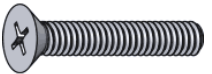
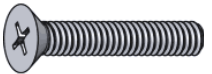

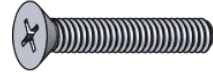





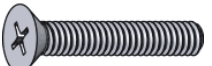
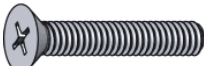

**PART # 0127-25 ASSORTMENT: STAINLESS MACHINE SCREW**

























01/22

<p>127-101 25</p>  <p>10-32 X 1/2</p>	<p>127-103 25</p>  <p>10-32 X 3/4</p>	<p>127-105 25</p>  <p>10-32 X 1</p>	<p>127-107 25</p>  <p>10-32 X 1-1/2</p>	<p>127-118 25</p>  <p>12-24 X 3/4</p>	<p>127-150 25</p>  <p>1/4-20 X 3/4</p>	<p>127-152 25</p>  <p>1/4-20 X 1</p>	<p>127-153 25</p>  <p>1/4-20 X 1-1/4</p>
<p>126-960 25</p>  <p>8-32 X 1/2</p>	<p>126-962 25</p>  <p>8-32 X 3/4</p>	<p>126-964 25</p>  <p>8-32 X 1</p>	<p>126-976 25</p>  <p>10-24 X 1/2</p>	<p>126-978 25</p>  <p>10-24 X 3/4</p>	<p>126-980 25</p>  <p>10-24 X 1</p>	<p>126-981 25</p>  <p>10-24 X 1-1/4</p>	<p>126-982 25</p>  <p>10-24 X 1-1/2</p>
<p>125-002 100</p>  <p>6-32</p>	<p>125-003 100</p>  <p>8-32</p>	<p>125-004 100</p>  <p>10-24</p>	<p>125-005 100</p>  <p>10-32</p>	<p>125-006 25</p>  <p>1/4-20</p>	<p>126-945 25</p>  <p>6-32 X 1/2</p>	<p>126-947 25</p>  <p>6-32 X 3/4</p>	<p>126-949 25</p>  <p>6-32 X 1</p>
<p>125-056 100</p>  <p>#6 LOCKS</p>	<p>125-057 100</p>  <p>#8 LOCKS</p>	<p>125-058 100</p>  <p>#10 LOCKS</p>		<p>125-034 100</p>  <p>#6 FLATS</p>	<p>125-035 100</p>  <p>#8 FLATS</p>	<p>125-036 100</p>  <p>#10 FLATS</p>	

**PART # 0127-35 ASSORTMENT: STAINLESS MACHINE SCREW**

01/22

<p>125-001 25</p>  <p>12-24</p>	<p>127-250 25</p>  <p>12-24 X 1/2</p>	<p>127-252 25</p>  <p>12-24 X 3/4</p>	<p>127-254 25</p>  <p>12-24 X 1</p>	<p>127-258 25</p>  <p>12-24 X 1-1/2</p>	<p>127-262 25</p>  <p>12-24 X 2</p>
<p>125-004 25</p>  <p>10-24</p>	<p>127-234 25</p>  <p>10-24 X 1/2</p>	<p>127-236 25</p>  <p>10-24 X 3/4</p>	<p>127-238 25</p>  <p>10-24 X 1</p>	<p>127-242 25</p>  <p>10-24 X 1-1/2</p>	<p>127-244 25</p>  <p>10-24 X 2</p>
<p>125-003 25</p>  <p>8-32</p>	<p>127-222 25</p>  <p>8-32 X 1/2</p>	<p>127-224 25</p>  <p>8-32 X 3/4</p>	<p>127-226 25</p>  <p>8-32 X 1</p>	<p>127-228 25</p>  <p>8-32 X 1-1/2</p>	<p>127-230 25</p>  <p>8-32 X 2</p>
<p>125-002 25</p>  <p>6-32</p>	<p>127-210 25</p>  <p>6-32 X 1/2</p>	<p>127-212 25</p>  <p>6-32 X 3/4</p>	<p>127-214 25</p>  <p>6-32 X 1</p>	<p>127-216 25</p>  <p>6-32 X 1-1/2</p>	<p>127-218 25</p>  <p>6-32 X 2</p>

<p>127-872 25</p>  <p>12 X 1/2</p>	<p>127-874 25</p>  <p>12 X 3/4</p>	<p>127-876 25</p>  <p>12 X 1</p>	<p>127-877 25</p>  <p>12 X 1-1/4</p>	<p>127-878 25</p>  <p>12 X 1-1/2</p>	<p>127-880 25</p>  <p>12 X 2</p>
<p>127-860 25</p>  <p>10 X 1/2</p>	<p>127-862 25</p>  <p>10 X 3/4</p>	<p>127-864 25</p>  <p>10 X 1</p>	<p>127-865 25</p>  <p>10 X 1-1/4</p>	<p>127-866 25</p>  <p>10 X 1-1/2</p>	<p>127-868 25</p>  <p>10 X 2</p>
<p>127-850 25</p>  <p>8 X 1/2</p>	<p>127-852 25</p>  <p>8 X 3/4</p>	<p>127-854 25</p>  <p>8 X 1</p>	<p>127-855 25</p>  <p>8 X 1-1/4</p>	<p>127-856 25</p>  <p>8 X 1-1/2</p>	<p>127-858 25</p>  <p>8 X 2</p>
<p>127-840 25</p>  <p>6 X 1/2</p>	<p>127-842 25</p>  <p>6 X 3/4</p>	<p>127-844 25</p>  <p>6 X 1</p>	<p>127-845 25</p>  <p>6 X 1-1/4</p>	<p>127-846 25</p>  <p>6 X 1-1/2</p>	<p>127-848 25</p>  <p>6 X 2</p>

















**CANTON FLEET - INDUSTRIAL SUPPLY**  
**COLUMBUS FLEET - INDUSTRIAL SUPPLY**

WWW.cfisgroup.com

(614) 332-7464

**PART # 0127-50 ASSORTMENT: STAINLESS HEX HEAD SCREWS**

























01/22

<p>127-762 25</p>  <p>14 X 3/4</p>	<p>127-763 25</p>  <p>14 X 1</p>	<p>127-765 25</p>  <p>14 X 1-1/2</p>	<p>127-767 25</p>  <p>14 X 2</p>		
<p>127-748 25</p>  <p>12 X 3/4</p>	<p>127-749 25</p>  <p>12 X 1</p>	<p>127-751 25</p>  <p>12 X 1-1/2</p>	<p>127-754 25</p>  <p>12 X 2</p>		
<p>127-739 25</p>  <p>10 X 1/2</p>	<p>127-740 25</p>  <p>10 X 3/4</p>	<p>127-742 25</p>  <p>10 X 1</p>	<p>127-744 25</p>  <p>10 X 1-1/2</p>		
<p>127-733 25</p>  <p>8 X 1/2</p>	<p>127-734 25</p>  <p>8 X 3/4</p>	<p>127-735 25</p>  <p>8 X 1</p>			

PART # 0127-70

**ASSORTMENT: PHIL STAINLESS BIND HEAD**

01/22

<p>127-688 25</p>  <p>12 X 3/4</p>	<p>127-689 25</p>  <p>12 X 1</p>	<p>127-690 25</p>  <p>12 X 1-1/4</p>	<p>127-691 25</p>  <p>12 X 1-1/2</p>	<p>127-714 25</p>  <p>14 X 1/2</p>	<p>127-718 25</p>  <p>14 X 3/4</p>
<p>127-668 25</p>  <p>10 X 3/4</p>	<p>127-669 25</p>  <p>10 X 1</p>	<p>127-670 25</p>  <p>10 X 1-1/4</p>	<p>127-671 25</p>  <p>10 X 1-1/2</p>	<p>127-685 25</p>  <p>12 X 1/2</p>	<p>127-719 25</p>  <p>14 X 1</p>
<p>127-647 25</p>  <p>8 X 1/2</p>	<p>127-648 25</p>  <p>8 X 3/4</p>	<p>127-649 25</p>  <p>8 X 1</p>	<p>127-650 25</p>  <p>8 X 1-1/4</p>	<p>127-667 25</p>  <p>10 X 1/2</p>	<p>127-720 25</p>  <p>14 X 1-1/4</p>
<p>127-632 25</p>  <p>6 X 3/8</p>	<p>127-633 25</p>  <p>6 X 1/2</p>	<p>127-635 25</p>  <p>6 X 3/4</p>	<p>127-637 25</p>  <p>6 X 1</p>	<p>127-645 25</p>  <p>8 X 3/8</p>	<p>127-721 25</p>  <p>14 X 1-1/2</p>



**CANTON FLEET - INDUSTRIAL SUPPLY**  
**COLUMBUS FLEET - INDUSTRIAL SUPPLY**















WWW.cfisgroup.com

(614) 332-7464

PART # 0127-60

**ASSORTMENT: STAINLESS PHIL FLAT HEAD TEK SCREWS**

01/22

25	25	25	127-982 25  14 X 1	127-984 25  14 X 1-1/4	127-986 25  14 X 1-1/2
		127-964 25  12 X 3/4	127-966 25  12 X 1	127-968 25  12 X 1-1/4	127-970 25  12 X 1-1/2
		127-938 25  10 X 3/4	127-940 25  10 X 1	127-942 25  10 X 1-1/4	127-944 25  10 X 1-1/2
		127-926 25  8 X 3/4	127-928 25  8 X 1	127-930 25  8 X 1-1/4	127-932 25  8 X 1-1/2



**CANTON FLEET - INDUSTRIAL SUPPLY**  
**COLUMBUS FLEET - INDUSTRIAL SUPPLY**

















WWW.cfisgroup.com

(614) 332-7464

PART # 0128-25

**ASSORTMENT: STAINLESS HEX HEAD TEKS**

01/22

128-918 25  14 X 3/4	128-919 25  14 X 1	128-921 25  14 X 1-1/2	128-923 25  14 X 2		
128-888 25  12 X 3/4	128-889 25  12 X 1	128-891 25  12 X 1-1/2	128-893 25  12 X 2		
128-867 25  10 X 1/2	128-868 25  10 X 3/4	128-869 25  10 X 1	128-870 25  10 X 1-1/4	128-871 25  10 X 1-1/2	
128-847 25  8 X 1/2	128-848 25  68X 3/4	128-849 25  8 X 1	128-851 25  8 X 1-1/2		



**CANTON FLEET - INDUSTRIAL SUPPLY**  
**COLUMBUS FLEET - INDUSTRIAL SUPPLY**

WWW.cfisgroup.com

(614) 332-7464

PART # 0128-75

# ASSORTMENT: STAINLESS PHIL TEKS

01/22

128-960 25

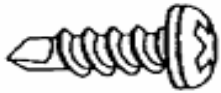

12 X 3/4

128-962 25

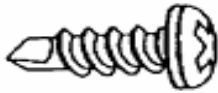

12 X 1

128-940 25

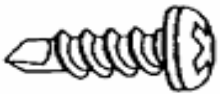

10 X 1/2

128-942 25

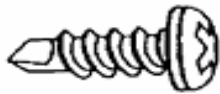

10 X 3/4

128-944 25

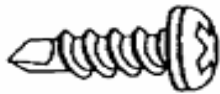

10 X 1

128-948 25

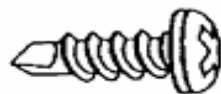

10 X 1-1/2

128-930 25

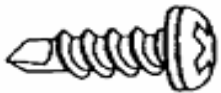

8 X 1/2

128-932 25

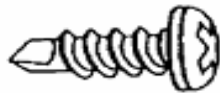

8 X 3/4

128-934 25

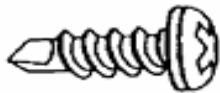

























8 X 1

PART # 0131-25

**ASSORTMENT: METRIC COARSE 8.8**













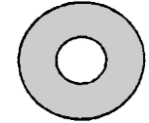





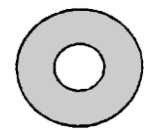



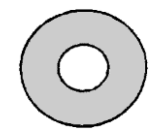

01/22

<p>131-010 10</p>  <p>10 X 1.50 NUT</p>	<p>131-070 25</p>  <p>10 LOCKS</p>	<p>132-020 10</p>  <p>10 X 1.50 X 20</p>	<p>132-030 10</p>  <p>10 X 1.50 X 30</p>	<p>132-040 10</p>  <p>10 X 1.50 X 40</p>	<p>132-050 10</p>  <p>10 X 1/50 X 50</p>
<p>131-008 20</p>  <p>8 X 1.25 NUT</p>	<p>131-068 50</p>  <p>8 LOCKS</p>	<p>131-812 15</p>  <p>8 X 1.25 X 12</p>	<p>131-820 15</p>  <p>8 X 1.25 X 20</p>	<p>131-830 15</p>  <p>8 X 1.25 X 30</p>	<p>131-840 15</p>  <p>8 X 1.25 X 40</p>
<p>131-006 25</p>  <p>6 X 1.00 NUT</p>	<p>131-066 50</p>  <p>6 LOCKS</p>	<p>131-610 25</p>  <p>6 X 1.00 X 10</p>	<p>131-616 25</p>  <p>6 X 1.00 X 16</p>	<p>131-620 25</p>  <p>6 X 1.00 X 20</p>	<p>131-630 25</p>  <p>6 X 1.00 X 30</p>
<p>131-005 25</p>  <p>5 X .80 NUT</p>	<p>131-065 50</p>  <p>5 LOCKS</p>	<p>131-510 25</p>  <p>5 X .80 X 10</p>	<p>131-516 25</p>  <p>5 X .80 X 16</p>	<p>131-520 25</p>  <p>5 X .80 X 20</p>	<p>131-530 25</p>  <p>5 X .80 X 30</p>

PART # 0131-27

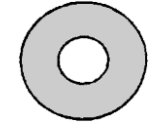
**ASSORTMENT: METRIC COARSE 8.8**























01/22

<p>131-012 10</p>  <p>12 X 1.75 NUT</p>	<p>131-072 25</p>  <p>12 LOCKS</p>	<p>131-042 25</p>  <p>12 FLATS</p>	<p>132-230 10</p>  <p>12 X 1.75 X 30</p>	<p>132-240 10</p>  <p>12 X 1.75 X 40</p>	<p>132-250 10</p>  <p>12 X 1.75 X 50</p>
<p>131-010 20</p>  <p>10 X 1.50 NUT</p>	<p>131-070 25</p>  <p>10 LOCKS</p>	<p>131-040 25</p>  <p>10 FLATS</p>	<p>132-020 10</p>  <p>10 X 1.50 X 20</p>	<p>132-030 10</p>  <p>10 X 1.50 X 30</p>	<p>132-040 10</p>  <p>10 X 1.50 X 40</p>
<p>131-008 25</p>  <p>8 X 1.25 NUT</p>	<p>131-068 25</p>  <p>8 LOCKS</p>	<p>131-038 25</p>  <p>8 FLATS</p>	<p>131-820 10</p>  <p>8 X 1.25 X 20</p>	<p>131-830 10</p>  <p>8 X 1.25 X 30</p>	<p>131-840 10</p>  <p>8 X 1.25 X 40</p>
<p>131-006 25</p>  <p>6 X 1.00 NUT</p>	<p>131-066 25</p>  <p>6 LOCKS</p>	<p>131-036 25</p>  <p>6 FLATS</p>	<p>131-616 25</p>  <p>6 X 1.00 X 16</p>	<p>131-620 25</p>  <p>6 X 1.00 X 20</p>	<p>131-630 25</p>  <p>6 X 1.00 X 30</p>

PART # 0131-30

**ASSORTMENT: METRIC COARSE 8.8**













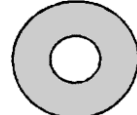









01/22

<p>131-012 10</p>  <p>12 X 1.75 NUT</p>	<p>132-228 10</p>  <p>12 X 1.75 X 25</p>	<p>132-230 10</p>  <p>12 X 1.75 X 30</p>	<p>132-240 10</p>  <p>12 X 1.75 X 40</p>	<p>132-250 10</p>  <p>12 X 1.75 X 50</p>	<p>132-260 10</p>  <p>12 X 1.75 X 60</p>
<p>131-010 20</p>  <p>10 X 1.50 NUT</p>	<p>132-020 10</p>  <p>10 X 1.50 X 20</p>	<p>132-030 10</p>  <p>10 X 1.50 X 30</p>	<p>132-040 10</p>  <p>10 X 1.50 X 40</p>	<p>132-050 10</p>  <p>10 X 1.50 X 50</p>	<p>132-060 10</p>  <p>10 X 1.50 X 60</p>
<p>131-008 25</p>  <p>8 X 1.25 NUT</p>	<p>131-812 15</p>  <p>8 X 1.25 X 12</p>	<p>131-820 15</p>  <p>8 X 1.25 X 20</p>	<p>131-830 15</p>  <p>8 X 1.25 X 30</p>	<p>131-840 10</p>  <p>8 X 1.25 X 40</p>	<p>131-850 10</p>  <p>8 X 1.25 X 50</p>
<p>131-006 25</p>  <p>6 X 1.00 NUT</p>	<p>131-610 25</p>  <p>6 X 1.00 X 10</p>	<p>131-616 25</p>  <p>6 X 1.00 X 16</p>	<p>131-620 25</p>  <p>6 X 1.00 X 20</p>	<p>131-630 25</p>  <p>6 X 1.00 X 30</p>	<p>131-640 25</p>  <p>6 X 1.00 X 40</p>

PART # 0131-35

**ASSORTMENT: METRIC FINE 8.8**











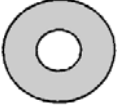
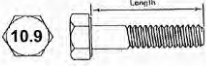
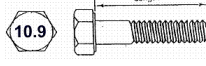
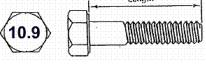
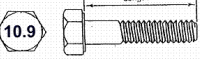
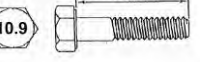

01/22

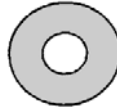
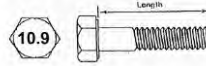
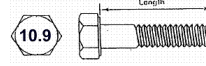
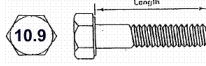
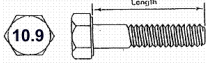
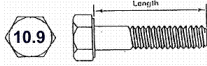
<p>131-028 10</p>  <p>12 X 1.50 NUT</p>	<p>131-072 20</p>  <p>12 LOCKS</p>	<p>131-042 10</p>  <p>12 FLATS</p>	<p>132-820 10</p>  <p>12 X 1.50 X 30</p>	<p>132-823 10</p>  <p>12 X 1.50 X 40</p>	<p>132-830 5</p>  <p>12 X 1.50 X 50</p>
<p>131-024 10</p>  <p>10 X 1.25 NUT</p>	<p>132-638 10</p>  <p>10 X 1.25 X 25</p>	<p>132-640 10</p>  <p>10 X 1.25 X 30</p>	<p>132-644 10</p>  <p>10 X 1.25 X 40</p>	<p>132-649 5</p>  <p>10 X 1.25 X 60</p>	
<p>131-020 10</p>  <p>10 X 1.00 NUT</p>	<p>131-070 20</p>  <p>10 LOCKS</p>	<p>131-040 10</p>  <p>10 FLATS</p>	<p>132-630 10</p>  <p>10 X 1.00 X 20</p>	<p>132-632 10</p>  <p>10 X 1.00 X 30</p>	<p>132-634 5</p>  <p>10 X 1.00 X 40</p>
<p>131-018 10</p>  <p>8 X 1.00 NUT</p>	<p>131-068 20</p>  <p>8 LOCKS</p>	<p>131-038 10</p>  <p>8 FLATS</p>	<p>132-322 10</p>  <p>8 X 1.00 X 20</p>	<p>132-326 10</p>  <p>8 X 1.00 X 30</p>	<p>132-328 10</p>  <p>8 X 1.00 X 40</p>

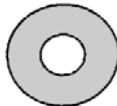
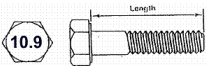
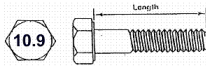
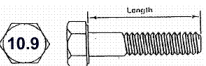
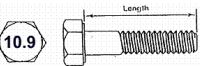
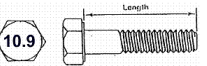
PART # 0135-10

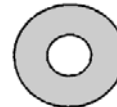
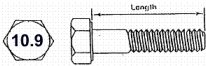
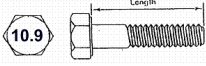
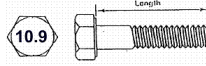
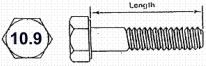
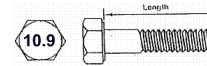
**ASSORTMENT: METRIC 10.9**

01/22

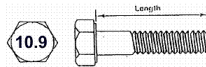
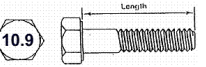
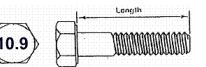
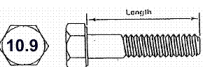
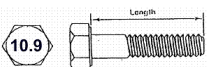
<p><b>135-014</b> 12  14 X 2.00 NUT</p>	<p><b>131-074</b> 25  14 LOCKS</p>	<p><b>135-044</b> 25  14 FLATS</p>	<p><b>135-816</b> 10  14 X 2.00 X 30</p>	<p><b>135-818</b> 10  14 X 2.00 X 40</p>	<p><b>135-822</b> 10  14 X 2.00 X 50</p>	<p><b>135-826</b> 10  14 X 2.00 X 60</p>	<p><b>135-830</b> 10  14 X 2.00 X 70</p>
<p><b>135-012</b> 25  12 X 1.75 NUT</p>	<p><b>131-072</b> 50  12 LOCKS</p>	<p><b>135-042</b> 25  12 FLATS</p>	<p><b>135-776</b> 25  12 X 1.75 X 25</p>	<p><b>135-777</b> 25  12 X 1.75 X 30</p>	<p><b>135-780</b> 12  12 X 1.75 X 40</p>	<p><b>135-784</b> 12  12 X 1.75 X 50</p>	<p><b>135-786</b> 12  12 X 1.75 X 60</p>
<p><b>135-010</b> 50  10 X 1.50 NUT</p>	<p><b>131-070</b> 50  10 LOCKS</p>	<p><b>135-040</b> 50  10 FLATS</p>	<p><b>135-746</b> 25  10 X 1.50 X 20</p>	<p><b>135-748</b> 25  10 X 1.50 X 25</p>	<p><b>135-750</b> 25  10 X 1.50 X 30</p>	<p><b>135-754</b> 12  10 X 1.50 X 40</p>	<p><b>135-758</b> 12  10 X 1.50 X 50</p>
<p><b>135-008</b> 50  8 X 1.25 NUT</p>	<p><b>131-068</b> 100  8 LOCKS</p>	<p><b>135-038</b> 100  8 FLATS</p>	<p><b>135-716</b> 25  8 X 1.25 X 20</p>	<p><b>135-718</b> 25  8 X 1.25 X 25</p>	<p><b>135-720</b> 25  8 X 1.25 X 30</p>	<p><b>135-722</b> 25  8 X 1.25 X 35</p>	<p><b>135-724</b> 25  8 X 1.25 X 40</p>
<p><b>135-006</b> 50  6-1.00 NUT</p>	<p><b>131-066</b> 100  6 LOCKS</p>	<p><b>135-036</b> 100  6 FLATS</p>	<p><b>135-646</b> 25  6 X 1.00 X 16</p>	<p><b>135-648</b> 25  6 X 1.00 X 20</p>	<p><b>135-650</b> 25  6 X 1.00 X 25</p>	<p><b>135-652</b> 25  6 X 1.00 X 30</p>	<p><b>135-656</b> 25  6 X 1.00 X 40</p>

PART # 0135-25

**ASSORTMENT: METRIC COARSE 10.9**



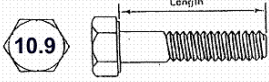
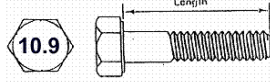
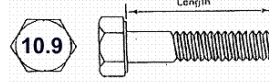
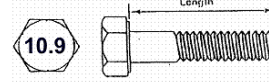
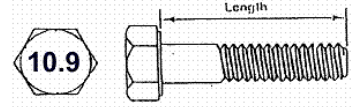
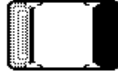
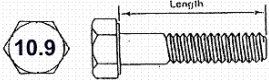
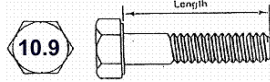
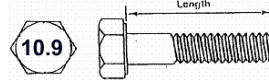
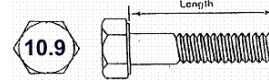
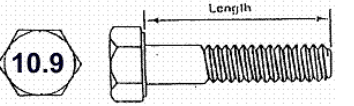
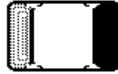
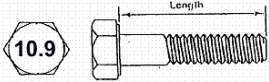
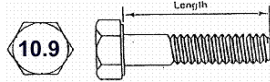
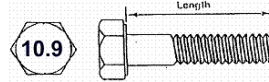
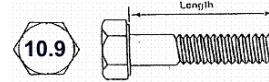
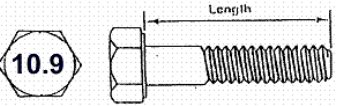
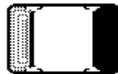
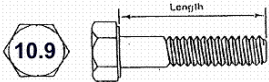
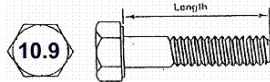
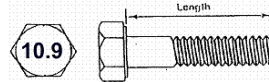
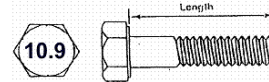





01/22

<p>135-012 10</p>  <p>12 X 1.75</p>	<p>135-776 10</p>  <p>12 X 1.75 X 25</p>	<p>135-777 10</p>  <p>12 X 1.75 X 30</p>	<p>135-778 10</p>  <p>12 X 1.75 X 35</p>	<p>135-780 10</p>  <p>12 X 1.75 X 40</p>	<p>135-784 10</p>  <p>12 X 1.75 X 50</p>
<p>135-010 20</p>  <p>10 X 1.50</p>	<p>135-744 10</p>  <p>10 X 1.50 X 16</p>	<p>135-746 10</p>  <p>10 X 1.50 X 20</p>	<p>135-748 10</p>  <p>10 X 1.50 X 25</p>	<p>135-750 10</p>  <p>10 X 1.50 X 30</p>	<p>135-752 10</p>  <p>10 X 1.50 X 35</p>
<p>135-008 25</p>  <p>8 X 1.25</p>	<p>135-714 15</p>  <p>8 X 1.25 X 16</p>	<p>135-716 15</p>  <p>8 X 1.25 X 20</p>	<p>135-718 15</p>  <p>8 X 1.25 X 25</p>	<p>135-720 10</p>  <p>8 X 1.25 X 30</p>	<p>135-722 10</p>  <p>8 X 1.25 X 35</p>
<p>135-006 25</p>  <p>6 X 1.00</p>	<p>135-646 25</p>  <p>6 X 1.00 X 16</p>	<p>135-648 25</p>  <p>6 X 1.00 X 20</p>	<p>135-650 25</p>  <p>6 X 1.00 X 25</p>	<p>135-652 25</p>  <p>6 X 1.00 X 30</p>	

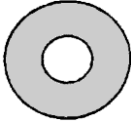
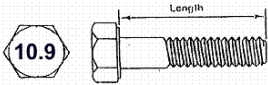
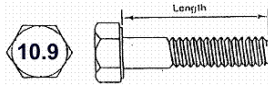
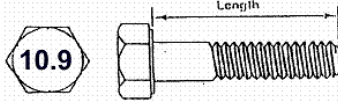
PART # 0135-40

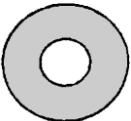
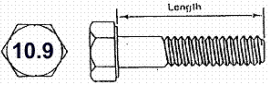
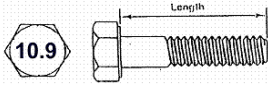
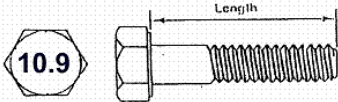
**ASSORTMENT: METRIC COARSE 10.9**

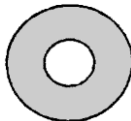
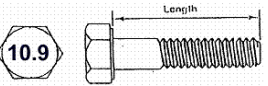
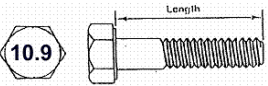
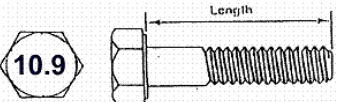

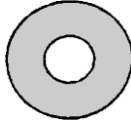
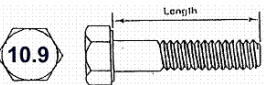
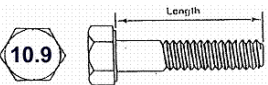
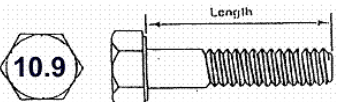



01/22

<p>135-012 10</p>  <p>12 X 1.75 NUT</p>	<p>131-072 25</p>  <p>12 LOCKS</p>	<p>135-042 25</p>  <p>12 FLATS</p>	<p>135-777 10</p>  <p>12 X 1.75 X 30</p>	<p>135-780 10</p>  <p>12 X 1.75 X 40</p>	<p>135-784 10</p>  <p>12 X 1.75 X 50</p>
<p>135-010 20</p>  <p>10 X 1.50 NUT</p>	<p>131-070 25</p>  <p>10 LOCKS</p>	<p>135-040 25</p>  <p>10 FLATS</p>	<p>135-746 10</p>  <p>10 X 1.50 X 20</p>	<p>135-750 10</p>  <p>10 X 1.50 X 30</p>	<p>135-754 10</p>  <p>10 X 1/50 X 40</p>
<p>135-008 25</p>  <p>8 X 1.25 NUT</p>	<p>131-068 25</p>  <p>8 LOCKS</p>	<p>135-038 25</p>  <p>8 FLATS</p>	<p>135-716 10</p>  <p>8 X 1.25 X 20</p>	<p>135-720 10</p>  <p>8 X 1.25 X 30</p>	<p>135-724 10</p>  <p>8 X 1.25 X 40</p>
<p>135-006 25</p>  <p>6 X 1.00 NUT</p>	<p>131-066 25</p>  <p>6 LOCKS</p>	<p>135-036 25</p>  <p>6 FLATS</p>	<p>135-646 25</p>  <p>6 X 1.00 X 16</p>	<p>135-648 25</p>  <p>6 X 1.00 X 20</p>	<p>135-652 25</p>  <p>6 X 1.00 X 30</p>

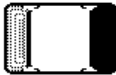
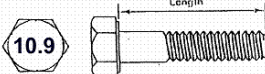
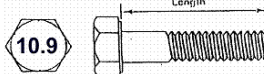
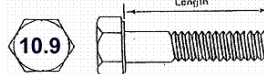
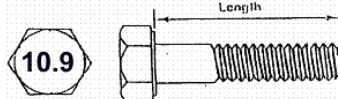
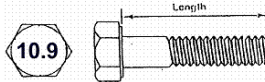
**PART # 0135-50**

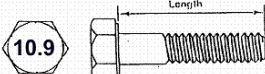
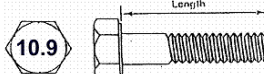
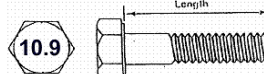
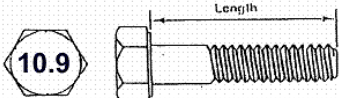
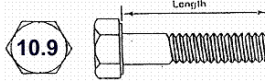
**ASSORTMENT: METRIC COARSE 10.9**

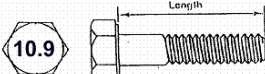
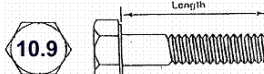
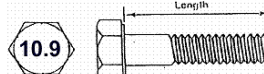
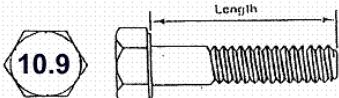
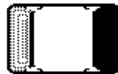

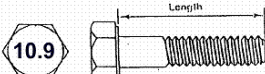
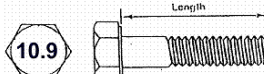
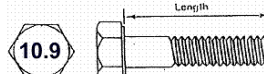
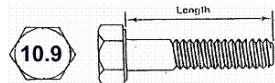
01/22

	<p><b>135-014</b> 10</p>  <p><b>14 X 2.00</b></p>	<p><b>135-814</b> 5</p>  <p><b>14 X 2.00 X 30</b></p>	<p><b>135-818</b> 5</p>  <p><b>14 X 2.00 X 40</b></p>	<p><b>135-822</b> 5</p>  <p><b>14 X 2.00 X 50</b></p>	<p><b>135-826</b> 5</p>  <p><b>14 X 2.00 X 60</b></p>
<p><b>135-652</b> 20</p>  <p><b>6 X 1.00 X 30</b></p>	<p><b>135-012</b> 10</p>  <p><b>12 X 1.75</b></p>	<p><b>135-776</b> 10</p>  <p><b>12 X 1.75 X 25</b></p>	<p><b>135-777</b> 10</p>  <p><b>12 X 1.75 X 30</b></p>	<p><b>135-780</b> 10</p>  <p><b>12 X 1.75 X 40</b></p>	<p><b>135-784</b> 5</p>  <p><b>12 X 1.75 X 50</b></p>
<p><b>135-648</b> 20</p>  <p><b>6 X 1.00 X 20</b></p>	<p><b>135-010</b> 20</p>  <p><b>10 X 1.50</b></p>	<p><b>135-746</b> 10</p>  <p><b>10 X 1.50 X 20</b></p>	<p><b>135-750</b> 10</p>  <p><b>10 X 1.50 X 30</b></p>	<p><b>135-754</b> 10</p>  <p><b>10 X 1.50 X 40</b></p>	<p><b>135-758</b> 5</p>  <p><b>10 X 1.50 X 50</b></p>
<p><b>135-006</b> 20</p>  <p><b>6 X 1.00</b></p>	<p><b>135-008</b> 20</p>  <p><b>8 X 1.25</b></p>	<p><b>135-716</b> 10</p>  <p><b>8 X 1.25 X 20</b></p>	<p><b>135-718</b> 10</p>  <p><b>8 X 1.25 X 25</b></p>	<p><b>135-720</b> 10</p>  <p><b>8 X 1.25 X 30</b></p>	<p><b>135-724</b> 10</p>  <p><b>8 X 1.25 X 40</b></p>

**PART # 0135-75**

**ASSORTMENT: METRIC FINE 10.9**

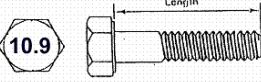
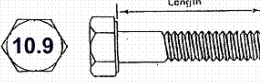
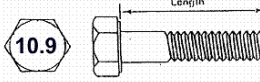
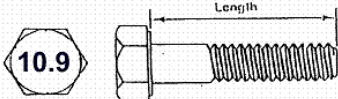
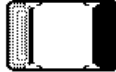
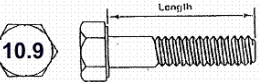
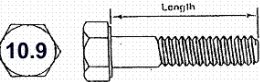
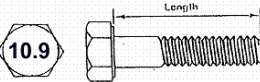
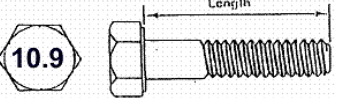
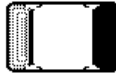
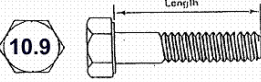
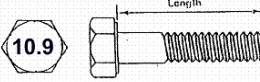
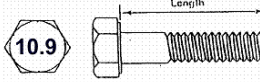
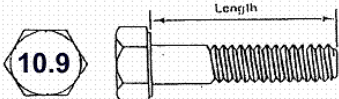

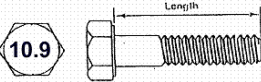
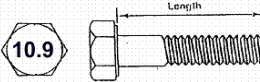
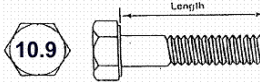
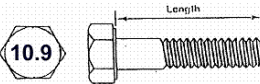





















01/22

<p><b>135-032</b> 5</p>  <p><b>14 X 1.50 NUTS</b></p>		<p><b>136-320</b> 5</p>  <p><b>14 X 1.50 X 30</b></p>	<p><b>136-322</b> 5</p>  <p><b>14 X 1.50 X 35</b></p>	<p><b>136-324</b> 5</p>  <p><b>14 X 1.50 X 40</b></p>	<p><b>136-328</b> 5</p>  <p><b>14 X 1.50 X 50</b></p>
<p><b>135-030</b> 10</p>  <p><b>12 X 1.50 NUTS</b></p>		<p><b>136-242</b> 5</p>  <p><b>12 X 1.50 X 20</b></p>	<p><b>136-244</b> 5</p>  <p><b>12 X 1.50 X 25</b></p>	<p><b>136-246</b> 5</p>  <p><b>12 X 1.50 X 30</b></p>	<p><b>136-250</b> 5</p>  <p><b>12 X 1.50 X 40</b></p>
<p><b>135-029</b> 10</p>  <p><b>10 X 1.25 NUTS</b></p>		<p><b>136-208</b> 10</p>  <p><b>10 X 1.25 X 20</b></p>	<p><b>136-210</b> 10</p>  <p><b>10 X 1.25 X 25</b></p>	<p><b>136-212</b> 10</p>  <p><b>10 X 1.25 X 30</b></p>	<p><b>136-216</b> 10</p>  <p><b>10 X 1.25 X 40</b></p>
<p><b>135-028</b> 10</p>  <p><b>10 X 1.00 NUTS</b></p>	<p><b>135-027</b> 10</p>  <p><b>8 X 1.00 NUTS</b></p>	<p><b>136-180</b> 10</p>  <p><b>8 X 1.00 X 20</b></p>	<p><b>136-182</b> 10</p>  <p><b>8 X 1.00 X 25</b></p>	<p><b>136-184</b> 10</p>  <p><b>8 X 1.00 X 30</b></p>	<p><b>136-188</b> 10</p>  <p><b>8 X 1.00 X 40</b></p>

PART # 0137-25

**ASSORTMENT: METRIC SOCKET HEADS**



















01/22

<p><b>137-430</b> 10</p>  <p>10 X 1.50 X 30</p>	<p><b>137-440</b> 10</p>  <p>10 X 1.50 X 40</p>	<p><b>137-450</b> 10</p>  <p>10 X 1.50 X 50</p>	<p><b>137-520</b> 10</p>  <p>12 X 1.75 X 20</p>	<p><b>137-525</b> 10</p>  <p>12 X 1.75 X 25</p>	<p><b>137-550</b> 10</p>  <p>12 X 1.75 X 50</p>
<p><b>137-315</b> 15</p>  <p>8 X 1.25 X 15</p>	<p><b>137-320</b> 15</p>  <p>8 X 1.25 X 20</p>	<p><b>137-330</b> 15</p>  <p>8 X 1.25 X 30</p>	<p><b>137-340</b> 15</p>  <p>8 X 1.25 X 40</p>	<p><b>137-350</b> 15</p>  <p>8 X 1.25 X 50</p>	<p><b>137-420</b> 15</p>  <p>10 X 1.50 X 20</p>
<p><b>137-134</b> 20</p>  <p>5 X 80 X 40</p>	<p><b>137-212</b> 20</p>  <p>6 X 1.00 X 12</p>	<p><b>137-220</b> 20</p>  <p>6 X 1.00 X 20</p>	<p><b>137-230</b> 20</p>  <p>6 X 1.00 X 30</p>	<p><b>137-234</b> 15</p>  <p>6 X 1.00 X 40</p>	<p><b>137-238</b> 15</p>  <p>6 X 1.00 X 50</p>
<p><b>137-076</b> 25</p>  <p>4 X 70 X 10</p>	<p><b>137-078</b> 25</p>  <p>4 X 70 X 16</p>	<p><b>137-080</b> 25</p>  <p>4 X 70 X 25</p>	<p><b>137-110</b> 25</p>  <p>5 X 80 X 10</p>	<p><b>137-120</b> 25</p>  <p>5 X 80 X 20</p>	<p><b>137-130</b> 25</p>  <p>5 X 80 X 30</p>

PART # 0137-28

**ASSORTMENT: METRIC SOCKET HEADS**

01/22

<p>137-420 10</p>  <p>10 X 1.50 X 20</p>	<p>137-430 10</p>  <p>10 X 1.50 X 30</p>	<p>137-440 10</p>  <p>10 X 1.50 X 40</p>	<p>137-450 10</p>  <p>10 X 1.50 X 50</p>		<p>137-520 10</p>  <p>12 X 1.75 X 20</p>
<p>137-315 15</p>  <p>8 X 1.25 X 15</p>	<p>137-320 15</p>  <p>8 X 1.25 X 20</p>	<p>137-330 15</p>  <p>8 X 1.25 X 30</p>	<p>137-350 15</p>  <p>8 X 1.25 X 50</p>		<p>137-525 10</p>  <p>12 X 1.75 X 25</p>
<p>137-212 20</p>  <p>6 X 1.00 X 12</p>	<p>137-220 20</p>  <p>6 X 1.00 X 20</p>	<p>137-230 20</p>  <p>6 X 1.00 X 30</p>			<p>137-550 10</p>  <p>12 X 1.75 X 50</p>
<p>137-110 20</p>  <p>5 X 80 X 10</p>	<p>137-120 20</p>  <p>5 X 80 X 20</p>	<p>137-130 20</p>  <p>5 X 80 X 30</p>	<p>137-134 20</p>  <p>5 X 80 X 40</p>		



**CANTON FLEET - INDUSTRIAL SUPPLY**  
**COLUMBUS FLEET - INDUSTRIAL SUPPLY**

















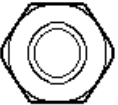







WWW.cfisgroup.com

(614) 332-7464

PART # 0141-16

**ASSORTMENT: METRIC PHIL MACHINE SCREW**

01/22

<p>131-008 25</p>  <p>8-1.25 NUT</p>	<p>141-184 10</p>  <p>8-1.25 X 16</p>	<p>141-186 10</p>  <p>8-1.25 X 20</p>	<p>141-188 10</p>  <p>8-1.25 X 25</p>	<p>141-190 10</p>  <p>8-1.25 X 30</p>	<p>141-192 10</p>  <p>8-1.25 X 35</p>
<p>131-006 25</p>  <p>6-1.00 NUT</p>	<p>141-160 25</p>  <p>6-1.00 X 10</p>	<p>141-162 25</p>  <p>6-1.00 X 12</p>	<p>141-164 25</p>  <p>6-1.00 X 16</p>	<p>141-166 15</p>  <p>6-1.00 X 20</p>	<p>141-168 15</p>  <p>6-1.00 X 25</p>
<p>131-005</p>  <p>6-1.00 NUT</p>	<p>141-140</p>  <p>5-.80 X 8</p>	<p>141-142</p>  <p>5-.80 X 10</p>	<p>141-146</p>  <p>5-.80 X 16</p>	<p>141-148</p>  <p>5-.80 X 20</p>	<p>141-150</p>  <p>5-.80 X 25</p>
<p>131-004</p>  <p>6-1.00 NUT</p>	<p>141-125</p>  <p>4-.70 X 8</p>	<p>141-127</p>  <p>4-.70 X 10</p>	<p>141-129</p>  <p>4-.70 X 16</p>	<p>141-131</p>  <p>4-.70 X 20</p>	<p>141-134</p>  <p>4-.70 X 30</p>



**CANTON FLEET - INDUSTRIAL SUPPLY**  
**COLUMBUS FLEET - INDUSTRIAL SUPPLY**

















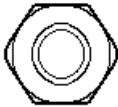







WWW.cfisgroup.com

(614) 332-7464

PART # 0141-20











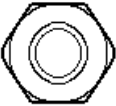



















**ASSORTMENT: METRIC PHIL MACHINE SCREW**

01/22

<p>131-036 25</p>  <p>6 MM FLATS</p>	<p>131-038 25</p>  <p>8 MM FLATS</p>	<p>131-040 25</p>  <p>10 MM FLATS</p>	<p>131-066 10</p>  <p>6 MM LOCKS</p>	<p>131-068 10</p>  <p>8 MM LOCKS</p>	<p>131-070 10</p>  <p>10 MM LOCKS</p>
<p>131-010 25</p>  <p>10-1-50 NUT</p>	<p>141-204 25</p>  <p>10-1.50 X 20</p>	<p>141-206 25</p>  <p>10-1.50 X 25</p>	<p>141-208 25</p>  <p>10-1.50 X 30</p>	<p>141-210 25</p>  <p>10-1.50 X 35</p>	<p>141-212 25</p>  <p>10-1.50 X 40</p>
<p>131-008 25</p>  <p>8-1.25 NUT</p>	<p>141-184 25</p>  <p>8-1.25 X 16</p>	<p>141-186 25</p>  <p>8-1.25 X 20</p>	<p>141-188 25</p>  <p>8-1.25 X 25</p>	<p>141-190 25</p>  <p>8-1.25 X 30</p>	<p>141-192 25</p>  <p>8-1.25 X 35</p>
<p>131-006 25</p>  <p>6-1-00 NUT</p>	<p>141-160 25</p>  <p>6-1.00 X 10</p>	<p>141-162 25</p>  <p>6-1.00 X 12</p>	<p>141-164 25</p>  <p>6-1.00 X 16</p>	<p>141-166 25</p>  <p>6-1.00 X 20</p>	<p>141-168 25</p>  <p>6-1.00 X 25</p>

**PART # 0141-25 ASSORTMENT: METRIC PHIL MACHINE SCREW**



















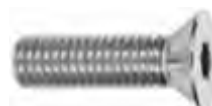

01/22

<p>131-428 25</p>  <p>10-1-50 NUT</p>	<p>131-040 25</p>  <p>10 MM FLATS</p>	<p>131-070 25</p>  <p>10 MM LOCKS</p>	<p>141-204 10</p>  <p>10-1.50 X 20</p>	<p>141-206 10</p>  <p>10-1.50 X 25</p>	<p>141-208 10</p>  <p>10-1.50 X 30</p>	<p>141-210 10</p>  <p>10-1.50 X 35</p>	<p>141-212 10</p>  <p>10-1.50 X 40</p>
<p>141-184 25</p>  <p>8 X 1.25 X 16</p>	<p>141-186 25</p>  <p>8-1.25 X 20</p>	<p>141-188 25</p>  <p>8-1.25 X 25</p>	<p>141-190 25</p>  <p>8-1.25 X 30</p>	<p>141-192 25</p>  <p>8-1.25 X 35</p>	<p>141-194 25</p>  <p>8-1.25 X 40</p>	<p>141-198 25</p>  <p>8-1.25 X 50</p>	
<p>141-170 25</p>  <p>6-1.00 X 30</p>	<p>141-172 25</p>  <p>6-1.00 X 35</p>	<p>141-174 25</p>  <p>6-1.00 X 40</p>	<p>141-176 25</p>  <p>6-1.00 X 45</p>	<p>141-178 25</p>  <p>6-1.00 X 50</p>	<p>131-424 25</p>  <p>8-1.25 NUT</p>	<p>131-038 25</p>  <p>8 MM FLATS</p>	<p>131-068 25</p>  <p>8 MM LOCKS</p>
<p>131-420 25</p>  <p>6-1-00 NUT</p>	<p>131-036 25</p>  <p>6 MM FLATS</p>	<p>131-066 25</p>  <p>6 MM LOCKS</p>	<p>141-160 25</p>  <p>6-1.00 X 10</p>	<p>141-162 25</p>  <p>6-1.00 X 12</p>	<p>141-164 25</p>  <p>6-1.00 X 16</p>	<p>141-166 25</p>  <p>6-1.00 X 20</p>	<p>141-168 25</p>  <p>6-1.00 X 25</p>

PART # 0149-25

**ASSORTMENT: FLAT SOCKET HEADS**























01/22

<p><b>149-832</b> 25</p>  <p>1/4-20 X 3/4</p>	<p><b>149-859</b> 25</p>  <p>5/16-18 X 1</p>	<p><b>149-901</b> 25</p>  <p>3/8-16 X 1</p>	<p><b>149-910</b> 25</p>  <p>3/8-16 X 2</p>	<p><b>149-976</b> 25</p>  <p>1/2-13 X 1-1/2</p>	<p><b>149-986</b> 25</p>  <p>1/2-13 X 3</p>
<p><b>149-830</b> 25</p>  <p>1/4-20 X 1/2</p>	<p><b>149-857</b> 25</p>  <p>5/16-18 X 3/4</p>	<p><b>149-899</b> 25</p>  <p>3/8-16 X 3/4</p>	<p><b>149-909</b> 25</p>  <p>3/8-16 X 1-3/4</p>	<p><b>149-974</b> 25</p>  <p>1/2-13 X 1 1/4</p>	<p><b>149-984</b> 25</p>  <p>1/2-13 X 2-1/2</p>
	<p><b>149-836</b> 25</p>  <p>1/4-20 X 1-1/2</p>	<p><b>149-861</b> 25</p>  <p>5/16-18 X 1-1/2</p>	<p><b>149-908</b> 25</p>  <p>3/8-16 X 1 1/2</p>	<p><b>149-972</b> 25</p>  <p>1/2-13 X 1</p>	<p><b>149-982</b> 25</p>  <p>1/2-13 X 2</p>
	<p><b>149-834</b> 25</p>  <p>1/4-20 X 1</p>	<p><b>149-860</b> 25</p>  <p>5/16-18 X 1-1/4</p>	<p><b>149-902</b> 25</p>  <p>3/8-16 X 1-1/4</p>	<p><b>149-970</b> 25</p>  <p>1/2-13 X 3/4</p>	<p><b>149-980</b> 25</p>  <p>1/2-13 X 1-3/4</p>

**PART # 0150-25**

**ASSORTMENT: SOCKET HEADS**











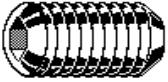



01/22

<p><b>150-456</b> 10</p>  <p>3/8-16 X 1-1/2</p>	<p><b>150-589</b> 10</p>  <p>1/2-13 X 1</p>	<p><b>150-590</b> 10</p>  <p>1/2-13 X 1-1/4</p>	<p><b>150-591</b> 10</p>  <p>1/2-13 X 1-1/2</p>	<p><b>150-592</b> 10</p>  <p>1/2-13 X 1-3/4</p>	<p><b>150-597</b> 10</p>  <p>1/2-13 X 2</p>
<p><b>150-351</b> 15</p>  <p>5/16-18 X 3/4</p>	<p><b>150-357</b> 15</p>  <p>5/16-18 X 1</p>	<p><b>150-371</b> 15</p>  <p>5/16-18 X 1-1/4</p>	<p><b>150-440</b> 15</p>  <p>3/8-16 X 3/4</p>	<p><b>150-447</b> 15</p>  <p>3/8-16 X 1</p>	<p><b>150-450</b> 15</p>  <p>3/8-16 X 1-1/4</p>
<p><b>150-270</b> 20</p>  <p>1/4-20 X 1/2</p>	<p><b>150-273</b> 20</p>  <p>1/4-20 X 5/8</p>	<p><b>150-276</b> 20</p>  <p>1/4-20 X 3/4</p>	<p><b>150-282</b> 20</p>  <p>1/4-20 X 1</p>	<p><b>150-294</b> 15</p>  <p>1/4-20 X 1-1/4</p>	<p><b>150-349</b> 15</p>  <p>5/16-18 X 1/2</p>
<p><b>150-168</b> 25</p>  <p>8-32 X 1/2</p>	<p><b>150-177</b> 25</p>  <p>8-32 X 3/4</p>	<p><b>150-186</b> 25</p>  <p>8-32 X 1</p>	<p><b>150-226</b> 25</p>  <p>10-24 X 1/2</p>	<p><b>150-228</b> 25</p>  <p>10-24 X 3/4</p>	<p><b>150-230</b> 25</p>  <p>10-24 X 1</p>

PART # 0153-25

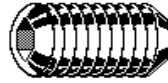
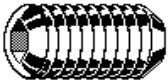
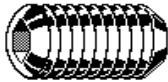
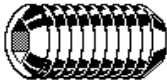
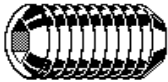
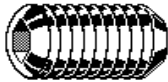
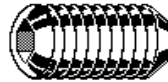
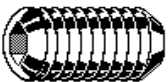
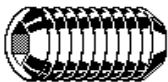
**ASSORTMENT: SET SCREWS**

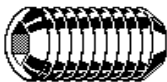
01/22

































<p>153-654 10</p>  <p>1/4-20 X 5/8</p>	<p>153-672 10</p>  <p>5/16-18 X 1/4</p>	<p>153-676 10</p>  <p>5/16-18 X 3/8</p>	<p>153-680 10</p>  <p>5/16-18 X 1/2</p>	<p>153-682 10</p>  <p>5/16-18 X 5/8</p>	<p>153-704 10</p>  <p>3/8-16 X 1/2</p>
<p>153-620 20</p>  <p>10-32 X 3/8</p>	<p>153-624 20</p>  <p>10-32 X 1/2</p>	<p>153-644 10</p>  <p>1/4-20 X 1/4</p>	<p>153-648 10</p>  <p>1/4-20 X 3/8</p>	<p>153-652 10</p>  <p>1/4-20 X 1/2</p>	<p>153-706 10</p>  <p>3/8-16 X 5/8</p>
<p>153-575 20</p>  <p>8-32 X 1/2</p>	<p>153-592 20</p>  <p>10-24 X 1/4</p>	<p>153-596 20</p>  <p>10-24 X 3/8</p>	<p>153-600 20</p>  <p>10-24 X 1/2</p>	<p>153-616 20</p>  <p>10-32 X 1/4</p>	<p>153-708 10</p>  <p>3/8-16 X 3/4</p>
<p>153-476 20</p>  <p>4-40 X 3/16</p>	<p>153-530 20</p>  <p>6-32 X 1/4</p>	<p>153-540 20</p>  <p>6-32 X 5/8</p>	<p>153-563 20</p>  <p>8-32 X 1/4</p>	<p>153-569 20</p>  <p>8-32 X 3/8</p>	<p>153-710 10</p>  <p>3/8-16 X 1</p>



**PART # 0165-25**

**ASSORTMENT: PHIL MACHINE SCREW**

01/22























<p><b>165-112</b> 25</p>  <p>10-32 X 1/2</p>	<p><b>165-114</b> 25</p>  <p>10-32 X 3/4</p>	<p><b>165-115</b> 25</p>  <p>10-32 X 1</p>	<p><b>165-125</b> 25</p>  <p>12-24 X 3/4</p>	<p><b>165-126</b> 25</p>  <p>12-24 X 1</p>	<p><b>165-154</b> 25</p>  <p>1/4-20 X 3/4</p>	<p><b>165-155</b> 25</p>  <p>1/4-20 X 1</p>	<p><b>165-156</b> 25</p>  <p>1/4-20 X 1-1/4</p>
<p><b>165-052</b> 25</p>  <p>8-32 X 1/2</p>	<p><b>165-054</b> 25</p>  <p>8-32 X 3/4</p>	<p><b>165-055</b> 25</p>  <p>8-32 X 1</p>	<p><b>165-073</b> 25</p>  <p>10-24 X 1/2</p>	<p><b>165-074</b> 25</p>  <p>10-24 X 3/4</p>	<p><b>165-075</b> 25</p>  <p>10-24 X 1</p>	<p><b>165-076</b> 25</p>  <p>10-24 X 1-1/4</p>	<p><b>165-077</b> 25</p>  <p>10-24 X 1-1/2</p>
<p><b>121-008</b> 100</p>  <p>6-32</p>	<p><b>121-010</b> 100</p>  <p>8-32</p>	<p><b>121-012</b> 100</p>  <p>10-24</p>	<p><b>121-014</b> 100</p>  <p>10-32</p>	<p><b>121-016</b> 25</p>  <p>12-24</p>	<p><b>121-018</b> 25</p>  <p>1/4-20</p>	<p><b>165-032</b> 25</p>  <p>6-32 X 1/2</p>	<p><b>165-034</b> 25</p>  <p>6-32 X 3/4</p>
<p><b>121-324</b> 200</p>  <p>#6 LOCKS</p>	<p><b>121-325</b> 200</p>  <p>#8 LOCKS</p>	<p><b>121-326</b> 200</p>  <p>#10 LOCKS</p>	<p><b>121-327</b> 100</p>  <p>#12 LOCKS</p>	<p><b>121-204</b> 200</p>  <p>#6 FLATS</p>	<p><b>121-205</b> 200</p>  <p>#8 FLATS</p>	<p><b>121-206</b> 200</p>  <p>#10 FLATS</p>	<p><b>121-208</b> 100</p>  <p>#14 FLATS</p>



**PART # 0165-35**

**ASSORTMENT: PHIL MACHINE SCREW**



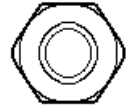







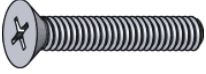
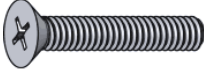
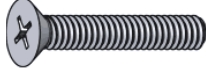



01/22

<p><b>165-115</b> 25</p>  <p>10-32 X 1</p>	<p><b>165-117</b> 25</p>  <p>10-32 X 1-1/2</p>		<p><b>165-154</b> 25</p>  <p>1/4-20 X 3/4</p>	<p><b>165-155</b> 25</p>  <p>1/4-20 X 1</p>	<p><b>165-157</b> 25</p>  <p>1/4-20 X 1-1/2</p>
<p><b>165-073</b> 25</p>  <p>10-24 X 1/2</p>	<p><b>165-074</b> 25</p>  <p>10-24 X 3/4</p>	<p><b>165-075</b> 25</p>  <p>10-24 X 1</p>	<p><b>165-077</b> 25</p>  <p>10-24 X 1-1/2</p>	<p><b>165-112</b> 25</p>  <p>10-32 X 1/2</p>	<p><b>165-114</b> 25</p>  <p>10-32 X 3/4</p>
<p><b>165-008</b> 25</p>  <p>6-32 X 3/4</p>	<p><b>165-051</b> 25</p>  <p>8-32 X 3/8</p>	<p><b>165-052</b> 25</p>  <p>8-32 X 1/2</p>	<p><b>165-054</b> 25</p>  <p>8-32 X 3/4</p>	<p><b>165-055</b> 25</p>  <p>8-32 X 1</p>	<p><b>165-057</b> 25</p>  <p>8-32 X 1-1/2</p>
<p><b>165-032</b> 25</p>  <p>6-32 X 1/2</p>	<p><b>121-008</b> 25</p>  <p>6-32</p>	<p><b>121-010</b> 25</p>  <p>8-32</p>	<p><b>121-012</b> 25</p>  <p>10-24</p>	<p><b>121-014</b> 25</p>  <p>10-32</p>	<p><b>121-018</b> 25</p>  <p>1/4-20</p>

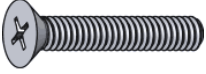
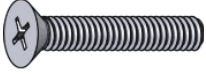
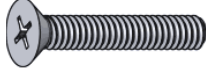
**PART # 0165-45**

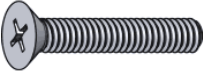
**ASSORTMENT: PHIL MACHINE SCREW**

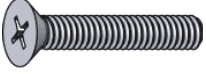
01/22

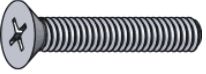

























<p><b>121-016</b> 25</p>  <p><b>12-24</b></p>	<p><b>165-344</b> 25</p>  <p><b>12-24 X 1/2</b></p>	<p><b>165-348</b> 25</p>  <p><b>12-24 X 3/4</b></p>	<p><b>165-352</b> 25</p>  <p><b>12-24 X 1</b></p>	<p><b>165-356</b> 25</p>  <p><b>12-24 X 1-1/2</b></p>	
<p><b>121-012</b> 25</p>  <p><b>10-24</b></p>	<p><b>165-288</b> 25</p>  <p><b>10-24 X 1/2</b></p>	<p><b>165-294</b> 25</p>  <p><b>10-24 X 3/4</b></p>	<p><b>165-298</b> 25</p>  <p><b>10-24 X 1</b></p>	<p><b>165-302</b> 25</p>  <p><b>10-24 X 1-1/2</b></p>	<p><b>165-306</b> 25</p>  <p><b>10-24 X 2</b></p>
<p><b>121-010</b> 25</p>  <p><b>8-32</b></p>	<p><b>165-262</b> 25</p>  <p><b>8-32 X 1/2</b></p>	<p><b>165-266</b> 25</p>  <p><b>8-32 X 3/4</b></p>	<p><b>165-270</b> 25</p>  <p><b>8-32 X 1</b></p>	<p><b>165-274</b> 25</p>  <p><b>8-32 X 1-1/2</b></p>	<p><b>165-276</b> 25</p>  <p><b>8-32 X 2</b></p>
<p><b>121-008</b> 25</p>  <p><b>6-32</b></p>	<p><b>165-232</b> 25</p>  <p><b>6-32 X 1/2</b></p>	<p><b>165-238</b> 25</p>  <p><b>6-32 X 3/4</b></p>	<p><b>165-242</b> 25</p>  <p><b>6-32 X 1</b></p>	<p><b>165-246</b> 25</p>  <p><b>6-32 X 1-1/2</b></p>	<p><b>165-248</b> 25</p>  <p><b>6-32 X 2</b></p>



PART # 0166-25

**ASSORTMENT: PHIL BIND HD SCREWS**

























01/22

	<p><b>166-082</b> 25  14 X 1/2</p>	<p><b>166-084</b> 25  14 X 3/4</p>	<p><b>166-085</b> 25  14 X 1</p>	<p><b>166-086</b> 25  14 X 1-1/4</p>	<p><b>166-087</b> 25  14 X 1-1/2</p>		
<p><b>166-047</b> 25  10 X 1-1/2</p>		<p><b>166-062</b> 25  12 X 1/2</p>	<p><b>166-064</b> 25  12 X 3/4</p>	<p><b>166-065</b> 25  12 X 1</p>	<p><b>166-066</b> 25  12 X 1-1/4</p>	<p><b>166-067</b> 25  12 X 1-1/2</p>	
<p><b>166-027</b> 25  8 X 1-1/2</p>		<p><b>166-041</b> 25  10 X 3/8</p>	<p><b>166-042</b> 25  10 X 1/2</p>	<p><b>166-043</b> 25  10 X 5/8</p>	<p><b>166-044</b> 25  10 X 3/4</p>	<p><b>166-045</b> 25  10 X 1</p>	<p><b>166-046</b> 25  10 X 1-1/4</p>
<p><b>166-001</b> 25  6 X 3/8</p>	<p><b>166-002</b> 25  6 X 1/2</p>	<p><b>166-004</b> 25  6 X 3/4</p>	<p><b>166-021</b> 25  8 X 3/8</p>	<p><b>166-022</b> 25  8 X 1/2</p>	<p><b>166-024</b> 25  8 X 3/4</p>	<p><b>166-025</b> 25  8 X 1</p>	<p><b>166-026</b> 25  8 X 1-1/4</p>

PART # 0166-50

**ASSORTMENT: PHIL FLAT HEAD SCREWS**

























01/22

<p>166-260 25</p>  <p>12 X 1/2</p>	<p>166-264 25</p>  <p>12 X 3/4</p>	<p>166-265 25</p>  <p>12 X 1</p>	<p>166-266 25</p>  <p>12 X 1-1/4</p>	<p>166-267 25</p>  <p>12 X 1-1/2</p>	<p>166-269 25</p>  <p>12 X 2</p>
<p>166-240 25</p>  <p>10 X 1/2</p>	<p>166-244 25</p>  <p>10 X 3/4</p>	<p>166-245 25</p>  <p>10 X 1</p>	<p>166-246 25</p>  <p>10 X 1-1/4</p>	<p>166-247 25</p>  <p>10 X 1-1/2</p>	<p>166-249 25</p>  <p>10 X 2</p>
<p>166-222 25</p>  <p>8 X 1/2</p>	<p>166-224 25</p>  <p>8 X 3/4</p>	<p>166-225 25</p>  <p>8 X 1</p>	<p>166-226 25</p>  <p>8 X 1-1/4</p>	<p>166-227 25</p>  <p>8 X 1-1/2</p>	<p>166-229 25</p>  <p>8 X 2</p>
<p>166-202 25</p>  <p>6 X 1/2</p>	<p>166-204 25</p>  <p>6 X 3/4</p>	<p>166-205 25</p>  <p>6 X 1</p>	<p>166-206 25</p>  <p>6 X 1-1/4</p>	<p>166-207 25</p>  <p>6 X 1-1/2</p>	<p>166-209 25</p>  <p>6 X 2</p>

**PART # 0167-25**

**ASSORTMENT: HEX HEAD SCREWS**

























01/22

<p><b>167-067</b> 25</p>  <p><b>12 X 1-1/2</b></p>	<p><b>167-104</b> 25</p>  <p><b>5/16 X 3/4</b></p>	<p><b>167-106</b> 25</p>  <p><b>5/16 X 1</b></p>	<p><b>167-108</b> 25</p>  <p><b>5/16 X 1-1/4</b></p>	<p><b>167-083</b> 25</p>  <p><b>14 X 3/4</b></p>	<p><b>167-089</b> 25</p>  <p><b>14 X 2</b></p>
<p><b>167-046</b> 25</p>  <p><b>10 X 1-1/4</b></p>	<p><b>167-047</b> 25</p>  <p><b>10 X 1-1/2</b></p>	<p><b>167-064</b> 25</p>  <p><b>12 X 3/4</b></p>	<p><b>167-065</b> 25</p>  <p><b>12 X 1</b></p>	<p><b>167-066</b> 25</p>  <p><b>12 X 1-1/4</b></p>	<p><b>167-087</b> 25</p>  <p><b>14 X 1-1/2</b></p>
<p><b>167-026</b> 25</p>  <p><b>8 X 1-1/4</b></p>	<p><b>167-027</b> 25</p>  <p><b>8 X 1-1/2</b></p>	<p><b>167-042</b> 25</p>  <p><b>10 X 1/2</b></p>	<p><b>167-044</b> 25</p>  <p><b>10 X 3/4</b></p>	<p><b>167-045</b> 25</p>  <p><b>10 X 1</b></p>	<p><b>167-086</b> 25</p>  <p><b>14 X 1-1/4</b></p>
<p><b>167-010</b> 25</p>  <p><b>6 X 1/2</b></p>	<p><b>167-012</b> 25</p>  <p><b>6 X 3/4</b></p>	<p><b>167-022</b> 25</p>  <p><b>8 X 1/2</b></p>	<p><b>167-024</b> 25</p>  <p><b>8 X 3/4</b></p>	<p><b>167-025</b> 25</p>  <p><b>8 X 1</b></p>	<p><b>167-085</b> 25</p>  <p><b>14 X 1</b></p>

PART # 0168-35

**ASSORTMENT: PHIL / HEX HEAD TEKS**

















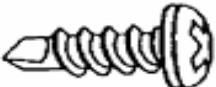
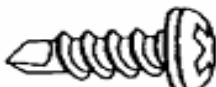

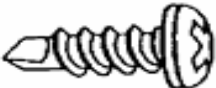

01/22

<p>166-084 25</p>  <p>14 X 3/4</p>	<p>166-085 25</p>  <p>14 X 1</p>	<p>166-087 25</p>  <p>14 X 1-1/2</p>	<p>168-062 25</p>  <p>14 X 3/4</p>	<p>168-063 25</p>  <p>14 X 1</p>	<p>168-065 25</p>  <p>14 X 1-1/2</p>
<p>166-064 25</p>  <p>12 X 3/4</p>	<p>166-065 25</p>  <p>12 X 1</p>	<p>166-066 25</p>  <p>12 X 1-1/4</p>	<p>168-042 25</p>  <p>12 X 3/4</p>	<p>168-043 25</p>  <p>12 X 1</p>	<p>168-044 25</p>  <p>12 X 1-1/4</p>
<p>166-044 25</p>  <p>10 X 3/4</p>	<p>166-045 25</p>  <p>10 X 1</p>	<p>166-046 25</p>  <p>10 X 1-1/4</p>	<p>168-022 25</p>  <p>10 X 3/4</p>	<p>168-023 25</p>  <p>10 X 1</p>	<p>168-024 25</p>  <p>10 X 1-1/4</p>
<p>166-022 25</p>  <p>8 X 1/2</p>	<p>166-024 25</p>  <p>8 X 3/4</p>	<p>166-025 25</p>  <p>8 X 1</p>	<p>168-010 25</p>  <p>8 X 1/2</p>	<p>168-012 25</p>  <p>8 X 3/4</p>	<p>168-013 25</p>  <p>8 X 1</p>

**PART # 0168-45**

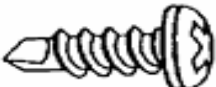
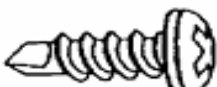
**ASSORTMENT: HEX HEAD TEKS**

01/22

<p>168-046 25</p>  <p>12 X 1-1/2</p>	<p>168-062 25</p>  <p>14 X 3/4</p>	<p>168-063 25</p>  <p>14 X 1</p>	<p>168-064 25</p>  <p>14 X 1-1/4</p>	<p>168-065</p>  <p>14 X 1-1/2</p>	<p>168-069 25</p>  <p>1/4 X 2-1/2</p>
<p>168-524 25</p>  <p>10 X 1</p>	<p>168-534 25</p>  <p>12 X 1</p>	<p>168-042 25</p>  <p>12 X 3/4</p>	<p>168-043 25</p>  <p>12 X 1</p>	<p>168-044</p>  <p>12 X 1-1/4</p>	<p>168-067 25</p>  <p>14 X 2</p>
<p>168-522 25</p>  <p>10 X 3/4</p>	<p>168-020 25</p>  <p>10 X 1/2</p>	<p>168-022 25</p>  <p>10 X 3/4</p>	<p>168-023 25</p>  <p>10 X 1</p>	<p>168-024 25</p>  <p>10 X 1-1/4</p>	<p>168-026 25</p>  <p>10 X 1-1/2</p>
<p>168-510 25</p>  <p>8 - 18 X 1/2</p>	<p>168-512 25</p>  <p>8 - 18 X 3/4</p>	<p>168-010 25</p>  <p>8 X 1/2</p>	<p>168-012 25</p>  <p>8 X 3/4</p>	<p>168-013 25</p>  <p>8 X 1</p>	<p>168-015 25</p>  <p>8 X 1-1/2</p>



**CANTON FLEET - INDUSTRIAL SUPPLY**  
**COLUMBUS FLEET - INDUSTRIAL SUPPLY**























WWW.cfisgroup.com

(614) 332-7464

PART # 0168-50

**ASSORTMENT: HEX HEAD TEKS**

01/22

168-046 25  12 X 1-1/2	168-062 25  14 X 3/4	168-063 25  14 X 1	168-064 25  14 X 1-1/4	168-065 25  14 X 1-1/2	168-067 25  1/4 X 2
168-023 25  10 X 1	168-024 25  10 X 1-1/4	168-026 25  10 X 1-1/2	168-042 25  12 X 3/4	168-043 25  12 X 1	168-044 25  12 X 1-1/4
168-013 25  8 X 1	168-014 25  8 X 1-1/4	168-015 25  8 X 1-1/2	168-020 25  10 X 1/2	168-022 25  10 X 3/4	
168-001 25  6 X 1/2	168-003 25  6 X 3/4	168-004 25  6 X 1	168-010 25  8 X 1/2	168-012 25  8 X 3/4	

**PART # 0168-85**

**ASSORTMENT: PHIL TEKS**

01/22

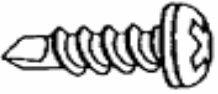
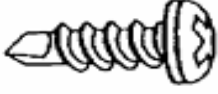
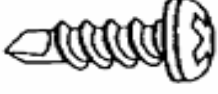
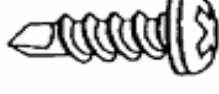
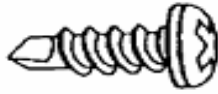
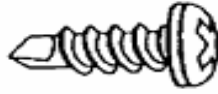
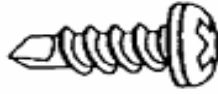
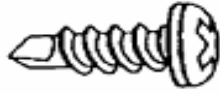
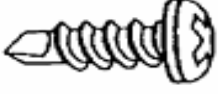
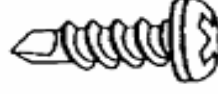
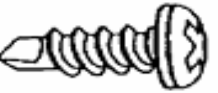
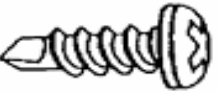
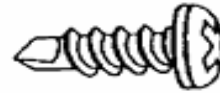
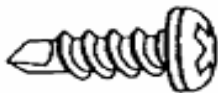
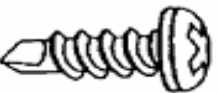
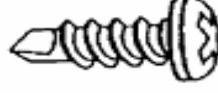
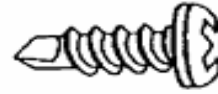
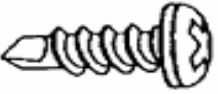
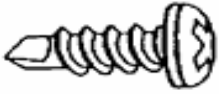
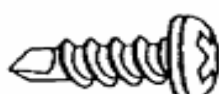
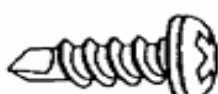
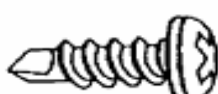































<p>168-533 25</p>  <p>12 X 3/4</p>	<p>168-534 25</p>  <p>12 X 1</p>	<p>168-535 25</p>  <p>12 X 1-1/4</p>	<p>168-536 25</p>  <p>12 X 1-1/2</p>		<p>168-542 25</p>  <p>14 X 3/4</p>
<p>168-524 25</p>  <p>10 X 1</p>	<p>168-525 25</p>  <p>10 X 1-1/4</p>	<p>168-526 25</p>  <p>10 X 1-1/2</p>	<p>168-528 25</p>  <p>10 X 2</p>		<p>168-544 25</p>  <p>14 X 1</p>
<p>168-514 25</p>  <p>8 X 1</p>	<p>168-515 25</p>  <p>8 X 1-1/4</p>	<p>168-516 25</p>  <p>8 X 1-1/2</p>	<p>168-520 25</p>  <p>10 X 1/2</p>	<p>168-522 25</p>  <p>10 X 3/4</p>	<p>169-545 25</p>  <p>14 X 1-1/4</p>
<p>168-502 25</p>  <p>6 X 1/2</p>	<p>168-505 25</p>  <p>6 X 3/4</p>	<p>168-506 25</p>  <p>6 X 1</p>	<p>168-510 25</p>  <p>8 X 1/2</p>	<p>168-512 25</p>  <p>8 X 3/4</p>	<p>168-547 25</p>  <p>14 X 1-1/2</p>



PART # 0168-90

**ASSORTMENT: BLACK TRIM SCREWS**

01/22

















<p>168-885 25</p>  <p>8 X 3/4</p>	<p>168-889 25</p>  <p>8 X 1</p>	<p>168-893 25</p>  <p>8 X 1-1/4</p>	<p>168-960 25</p>  <p>8 X 1/2</p>	<p>168-964 25</p>  <p>8 X 3/4</p>	<p>168-968 25</p>  <p>8 X 1</p>	<p>168-986 25</p>  <p>10 X 3/4</p>	<p>168-990 25</p>  <p>10 X 1</p>
<p>166380 25</p>  <p>10 X 1-1/4 10HD</p>	<p>168-562 25</p>  <p>8 X 1/2</p>	<p>168-564 25</p>  <p>8 X 3/4</p>	<p>168-566 25</p>  <p>8 X 1</p>	<p>168-570 25</p>  <p>10 X 1/2</p>	<p>168-572 25</p>  <p>10 X 3/4</p>	<p>168-574 25</p>  <p>10 X 1</p>	<p>168-881 25</p>  <p>8 X 1/2</p>
<p>166352 25</p>  <p>8 X 1 8HD</p>	<p>166-365 25</p>  <p>10 X 1/2 8HD</p>	<p>166-367 25</p>  <p>10 X 1/2 10HD</p>	<p>166-370 25</p>  <p>10 X 3/4 10HD</p>	<p>166-372 25</p>  <p>10 X 3/4 10HD</p>	<p>166-374 25</p>  <p>10 X 1 8HD</p>	<p>166-376 25</p>  <p>10 X 1 10HD</p>	<p>166-378 25</p>  <p>10 X 1-1/4 8HD</p>
<p>166-322 25</p>  <p>6 X 1/2 6HD</p>	<p>166-324 25</p>  <p>6 X 3/4 6HD</p>	<p>166-326 25</p>  <p>6 X 1 6HD</p>	<p>166-338 25</p>  <p>8 X 1/2 6HD</p>	<p>166-340 25</p>  <p>8 X 1/2 8HD</p>	<p>166-344 25</p>  <p>8 X 3/4 6HD</p>	<p>166-346 25</p>  <p>8 X 3/4 8HD</p>	<p>166-350 25</p>  <p>8 X 1 6HD</p>



PART # 0169-85

**ASSORTMENT: HEX TYPE F THREAD CUTTER**

01/22

			169-342 25  3/8-16 X 3/4	169-343 25  3/8-16 X 1	169-345 25  3/8-16 X 1-1/2
169-290 25  1/4-20 X 1/2	169-294 25  1/4-20 X 3/4	169-295 25  1/4-20 X 1		169-314 25  5/16-18 X 3/4	169-316 25  5/16-18 X 1
169-254 25  10-24 X 1/2	169-258 25  10-24 X 3/4	169-260 25  10-24 X 1	AV-8437 25  12-24 X 1/2	169-270 25  12-24 X 3/4	AV-8439 25  12-24 X 1
AV-5766 25  8-32 X 3/8	169-224 25  8-32 X 1/2	AV-5769 25  8-32 X 3/4			



**CANTON FLEET - INDUSTRIAL SUPPLY**  
**COLUMBUS FLEET - INDUSTRIAL SUPPLY**

























WWW.cfisgroup.com

(614) 332-7464

**PART # 0191-25**

**ASSORTMENT: COTTER PINS**











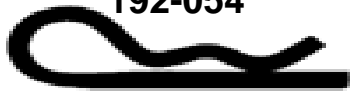

01/22

<p>191-006 25</p>  <p>1/16 X 2</p>	<p>191-046 25</p>  <p>3/32 X 2</p>	<p>191-086 25</p>  <p>1/8 X 2</p>	<p>191-099 25</p>  <p>5/32 X 2-1/2</p>	<p>191-242 10</p>  <p>1/4 X 1</p>	<p>191-266 10</p>  <p>5/16 X 2</p>
<p>191-004 25</p>  <p>1/16 X 1-1/2</p>	<p>191-044 25</p>  <p>3/32 X 1-1/2</p>	<p>191-084 25</p>  <p>1/8 X 1-1/2</p>	<p>191-097 25</p>  <p>5/32 X 2</p>	<p>191-208 10</p>  <p>3/16 X 2-1/2</p>	<p>191-264 10</p>  <p>5/16 X 1-1/2</p>
<p>191-002 25</p>  <p>1/16 X 1</p>	<p>191-042 25</p>  <p>3/32 X 1</p>	<p>191-082 25</p>  <p>1/8 X 1</p>	<p>191-095 25</p>  <p>5/32 X 1-1/2</p>	<p>191-204 10</p>  <p>3/16 X 1-1/2</p>	<p>191-248 10</p>  <p>1/4 X 2-1/2</p>
<p>191-000 25</p>  <p>1/16 X 1/2</p>	<p>191-040 25</p>  <p>3/32 X 1/2</p>	<p>191-081 25</p>  <p>1/8 X 3/4</p>	<p>191-092 25</p>  <p>5/32 X 3/4</p>	<p>191-201 10</p>  <p>3/16 X 1</p>	<p>191-244 10</p>  <p>1/4 X 1-1/2</p>

PART # 0192-25

**ASSORTMENT: HAIR PINS**

01/22

	<p>192-085 5</p>  <p>1/4 X 4-3/16</p>		<p>193-164 2</p>  <p>3/8 X 2-1/2 SQUARE</p>
<p>192-054 20</p>  <p>9/64 X 2</p>	<p>192-070 10</p>  <p>3/16 X 3-3/4</p>		<p>193-144 2</p>  <p>5/16 X 2-1/2 SQUARE</p>
<p>192-052 20</p>  <p>1/8 X 1-1/4</p>	<p>192-066 10</p>  <p>5/32 X 3</p>		<p>193-140 2</p>  <p>1/4 X 1-3/4 SQUARE</p>
<p>192-028 20</p>  <p>7/64 X 1-5/8</p>	<p>192-058 10</p>  <p>1/8 X 2</p>		<p>193-104 2</p>  <p>1/4 X 2-1/2 ROUND</p>
<p>192-024 20</p>  <p>3/32 X 1-9/16</p>			
<p>192-016 20</p>  <p>5/64 X 1-7/8</p>			



**CANTON FLEET - INDUSTRIAL SUPPLY**  
**COLUMBUS FLEET - INDUSTRIAL SUPPLY**





















WWW.cfisgroup.com

(614) 332-7464

PART # 0192-35

**ASSORTMENT: CLEVIS PINS**

01/22













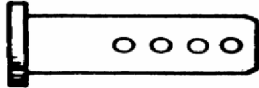
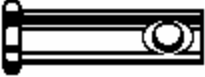
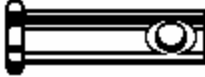
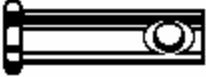
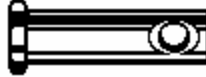
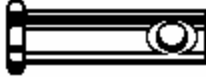
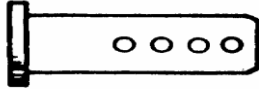

<p>192-060 5</p>  <p>.1250 X 2-7/8</p>		<p>192-066 5</p>  <p>5/32 X 2-15/16</p>			<p>192-088 5</p>  <p>5/16 X 4</p>
<p>192-028 25</p>  <p>7/64 X 1-5/8</p>	<p>192-030 25</p>  <p>3/32 X 2-5/16</p>	<p>192-052 25</p>  <p>1/8 X 1-1/4</p>	<p>192-054 10</p>  <p>9/64 X 1-15/16</p>	<p>192-058 10</p>  <p>9/64 X 2-1/2</p>	<p>192-085 5</p>  <p>1/4 X 4-3/16</p>
<p>192-015 25</p>  <p>.54 X 31/32</p>	<p>192-016 25</p>  <p>1/16 X 1-9/16</p>	<p>192-017 25</p>  <p>.720 X 1-3/32</p>	<p>192-018 25</p>  <p>5/64 X 1-7/8</p>	<p>192-024 25</p>  <p>3/32 X 1-9/16</p>	<p>192-070 5</p>  <p>3/16 X 3-3/4</p>
<p>192-004 25</p>  <p>.082 X .600</p>	<p>192-006 25</p>  <p>.032 X 7/16</p>	<p>192-008 25</p>  <p>.042 X 15/16</p>	<p>192-010 25</p>  <p>0.42 X 1</p>	<p>192-014 25</p>  <p>.0470 X 1</p>	<p>192-068 5</p>  <p>3/16 X 3-1/4</p>

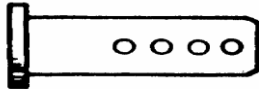

**PART # 0193-25**

**ASSORTMENT: CLEVIS PINS**

01/22

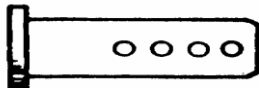







193-078 5  7/16 X 1-1/2	193-082 5  7/16 X 2	193-080 5  1/2 X 1-1/2	193-088 5  1/2 X 1-3/4	193-006 5  5/16 X 2	193-015 2  5/8 X 3
193-064 5  3/8 X 1	193-066 5  3/8 X 1-1/4	193-068 5  3/8 X 1-1/2	193-072 5  3/8 X 2	193-090 5  1/2 X 2	193-012 5  1/2 X 2
193-050 5  5/16 X 1	193-052 5  5/16 X 1-1/4	193-054 5  5/16 X 1-1/2	193-060 5  5/16 X 2	193-004 5  1/4 X 2	193-010 5  7/16 X 2
	193-038 5  1/4 X 1	193-040 5  1/4 X 1-1/4	193-042 5  1/4 X 1-1/2	193-046 5  1/4 X 2	193-008 5  3/8 X 2

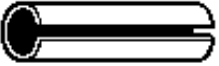
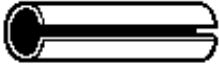
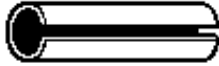
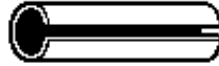
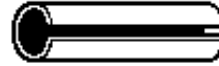
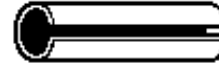
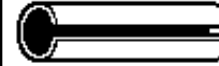
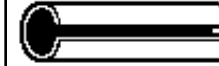
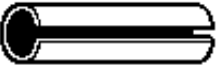
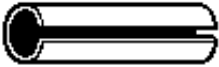
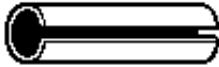
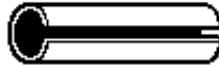
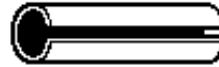
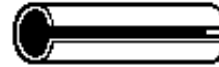
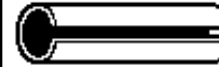
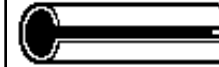
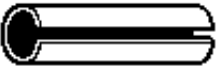
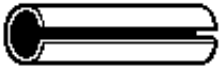
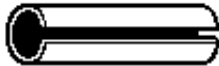
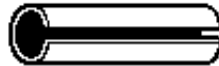
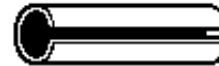
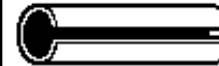
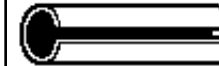

PART # 0194-70

# ASSORTMENT: SPRING PINS

01/22











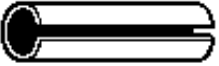
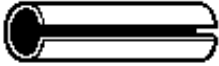
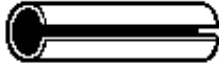

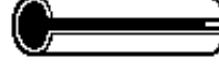
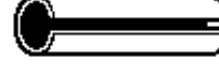
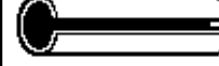
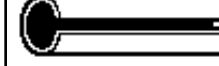
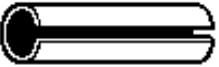
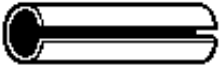
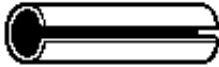

194-412 10  5/16 X 1	194-414 10  5/16 X 1-1/2	194-418 10  5/16 X 2	194-420 10  5/16 X 2-1/2	194-432 5  3/8 X 1	194-436 5  3/8 X 1-1/2	194-440 5  3/8 X 2	194-442 5  3/8 X 2-1/2
194-344 15  3/16 X 2	194-350 15  7/32 X 3/4	194-352 15  7/32 X 1	194-356 15  7/32 X 1-1/2	194-374 10  1/4 X 1	194-378 10  1/4 X 1-1/2	194-382 10  1/4 X 2	194-386 10  1/4 X 2-1/2
194-298 20  1/8 X 2	194-318 20  5/32 X 3/4	194-320 20  5/32 X 1	194-324 20  5/32 X 1-1/2		194-334 20  3/16 X 3/4	194-336 20  3/16 X 1	194-340 20  3/16 X 1-1/2
194-228 25  1/16 X 3/4	194-248 25  5/64 X 3/4	194-264 25  3/32 X 1/2	194-268 25  3/32 X 3/4	194-270 25  3/32 X 1	194-288 25  1/8 X 3/4	194-290 25  1/8 X 1	194-294 25  1/8 X 1-1/2

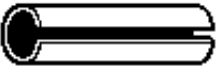
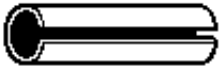
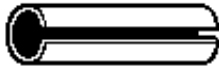

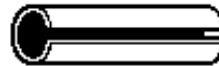
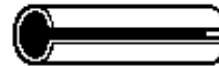
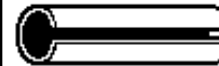
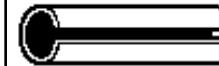
PART # 0194-75

**ASSORTMENT: SPRING PINS**



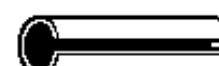
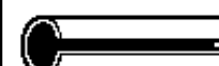
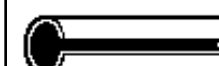

















01/22

<p><b>194-944</b> 30</p>  <p>4mm X 14</p>	<p><b>194-946</b> 30</p>  <p>4mm X 20</p>	<p><b>194-950</b> 30</p>  <p>5mm X 30</p>	<p><b>194-958</b> 30</p>  <p>6mm X 30</p>	<p><b>194-432</b> 5</p>  <p>3/8 X 1</p>	<p><b>194-436</b> 5</p>  <p>3/8 X 1-1/2</p>	<p><b>194-440</b> 5</p>  <p>3/8 X 2</p>	<p><b>194-442</b> 5</p>  <p>3/8 X 2-1/2</p>
<p><b>194-932</b> 30</p>  <p>3mm X 18</p>	<p><b>194-940</b> 30</p>  <p>4mm X 8</p>	<p><b>194-942</b> 30</p>  <p>4mm X 10</p>		<p><b>194-412</b> 10</p>  <p>5/16 X 1</p>	<p><b>194-414</b> 10</p>  <p>5/16 X 1-1/2</p>	<p><b>194-418</b> 10</p>  <p>5/16 X 2</p>	<p><b>194-420</b> 10</p>  <p>5/16 X 2-1/2</p>
<p><b>194-920</b> 30</p>  <p>2.5mm X 18</p>	<p><b>194-926</b> 30</p>  <p>3mm X 6</p>	<p><b>194-930</b> 30</p>  <p>3mm X 12</p>	<p><b>194-288</b> 25</p>  <p>1/8 X 3/4</p>	<p><b>194-374</b> 10</p>  <p>1/4 X 1</p>	<p><b>194-378</b> 10</p>  <p>1/4 X 1-1/2</p>	<p><b>194-382</b> 10</p>  <p>1/4 X 2</p>	<p><b>194-386</b> 10</p>  <p>1/4 X 2-1/2</p>
<p><b>194-910</b> 40</p>  <p>1.5mm X 6</p>	<p><b>194-914</b> 30</p>  <p>2mm X 18</p>	<p><b>194-916</b> 30</p>  <p>2.5mm X 10</p>	<p><b>194-290</b> 25</p>  <p>1/8 X 1</p>	<p><b>194-294</b> 25</p>  <p>1/8 X 1-1/2</p>	<p><b>194-334</b> 20</p>  <p>3/16 X 3/4</p>	<p><b>194-336</b> 20</p>  <p>3/16 X 1</p>	<p><b>194-340</b> 20</p>  <p>3/16 X 1-1/2</p>

**PART # 0195-25**

**ASSORTMENT: WOODRUFF KEYS**

01/22

<p>195-072 5</p>  <p>5/16 X 1</p>	<p>195-074 5</p>  <p>5/16 X 1-1/8</p>	<p>195-076 5</p>  <p>5/16 X 1-1/4</p>	<p>195-080 5</p>  <p>3/8 X 1</p>	<p>195-082 5</p>  <p>3/8 X 1-1/4</p>	
<p>195-038 10</p>  <p>1/4 X 3/4</p>	<p>195-040 10</p>  <p>1/4 X 7/8</p>	<p>195-046 10</p>  <p>1/4 X 1</p>	<p>195-048 10</p>  <p>1/4 X 1-1/8</p>	<p>195-050 10</p>  <p>1/4 X 1-1/4</p>	
<p>195-026 15</p>  <p>5/32 X 3/4</p>	<p>195-028 15</p>  <p>5/32 X 7/8</p>	<p>195-030 15</p>  <p>3/16 X 3/4</p>	<p>195-032 15</p>  <p>3/16 X 7/8</p>	<p>195-034 15</p>  <p>3/16 X 1</p>	
<p>195-010 15</p>  <p>3/32 X 1/2</p>	<p>195-012 15</p>  <p>3/32 X 5/8</p>	<p>195-016 15</p>  <p>1/8 X 1/2</p>	<p>195-018 15</p>  <p>1/8 X 5/8</p>	<p>195-024 15</p>  <p>5/32 X 5/8</p>	



**CANTON FLEET - INDUSTRIAL SUPPLY**  
**COLUMBUS FLEET - INDUSTRIAL SUPPLY**















WWW.cfisgroup.com

(614) 332-7464

PART # 0196-25

**ASSORTMENT: E-RINGS**

01/22

























<p>196-122 10</p>  <p>9/16</p>	<p>196-124 10</p>  <p>5/8</p>	<p>196-126 10</p>  <p>3/4</p>	<p>196-128 10</p>  <p>7/8</p>	<p>196-130 10</p>  <p>1"</p>	
<p>196-112 25</p>  <p>1/4</p>	<p>196-114 25</p>  <p>5/16</p>	<p>196-116 25</p>  <p>3/8</p>	<p>196-118 25</p>  <p>7/16</p>	<p>196-120 25</p>  <p>1/2</p>	
<p>196-102 25</p>  <p>3/32</p>	<p>196-104 25</p>  <p>1/8</p>	<p>196-106 25</p>  <p>5/32</p>	<p>196-108 25</p>  <p>3/16</p>	<p>196-110 25</p>  <p>7/32</p>	



**PART # 0197-25**

# **ASSORTMENT: INT / EXT SNAP RINGS**

























01/22

197-422 15  5/8 EXT	197-424 10  3/4 EXT	197-416 10  7/8 EXT	197-428 10  1' EXT	197-432 5  1-1/8 EXT	197-436 5  1-1/4 EXT
197-406 25  1/4 EXT	197-408 25  5/16 EXT	197-412 25  3/8 EXT	197-414 25  7/16 EXT	197-416 25  1/2 EXT	197-420 20  9/16 EXT
197-322 15  5/8 INT	197-324 10  3/4 INT	197-326 10  7/8 INT	197-328 10  1 INT	197-332 5  1-1/8 INT	197-336 5  1-1/4 INT
197-306 25  1/4 INT	197-308 25  5/16 INT	197-312 25  3/8 INT	197-314 25  7/16 INT	197-316 25  1/2 INT	197-320 20  9/16 INT

PART # 0197-35

**ASSORTMENT: EXTERNAL SNAP RINGS**

01/22























<p>197-408 20</p>  <p>5/16 EXT</p>	<p>197-416 15</p>  <p>1/2 EXT</p>	<p>197-424 10</p>  <p>3/4 EXT</p>	<p>197-432 5</p>  <p>1-1/8 EXT</p>	<p>197-440 5</p>  <p>1-3/8 EXT</p>	<p>197-448 5</p>  <p>1-3/4 EXT</p>
<p>197-407 20</p>  <p>9/32 EXT</p>	<p>197-414 15</p>  <p>7/16 EXT</p>	<p>197-423 10</p>  <p>11/16 EXT</p>	<p>197-430 5</p>  <p>1-1/16 EXT</p>	<p>197-438 5</p>  <p>1-5/16 EXT</p>	<p>197-446 5</p>  <p>1-5/8 EXT</p>
<p>197-406 20</p>  <p>1/4 EXT</p>	<p>197-412 15</p>  <p>3/8 EXT</p>	<p>197-422 10</p>  <p>5/8 EXT</p>	<p>197-428 5</p>  <p>1 EXT</p>	<p>197-436 5</p>  <p>1-1/4 EXT</p>	<p>197-444 5</p>  <p>1-1/2 EXT</p>
<p>197-404 20</p>  <p>3/16 EXT</p>	<p>197-410 15</p>  <p>11/32 EXT</p>	<p>197-420 10</p>  <p>9/16 EXT</p>	<p>197-426 5</p>  <p>7/8 EXT</p>	<p>197-434 5</p>  <p>1-3/16 EXT</p>	<p>197-442 5</p>  <p>1-7/16 EXT</p>



**PART # 0197-45**

**ASSORTMENT: INTERNAL SNAP RINGS**

01/22































<p><b>197-314</b> 20  <b>7/16 EXT</b></p>	<p><b>197-323</b> 15  <b>11/16 EXT</b></p>	<p><b>197-328</b> 10  <b>1" EXT</b></p>	<p><b>197-336</b> 5  <b>1-1/4 EXT</b></p>	<p><b>197-340</b> 5  <b>1-3/8 EXT</b></p>	<p><b>197-348</b> 5  <b>1-3/4 EXT</b></p>
<p><b>197-312</b> 20  <b>3/8 EXT</b></p>	<p><b>197-322</b> 15  <b>5/8 EXT</b></p>	<p><b>197-326</b> 10  <b>7/8 EXT</b></p>	<p><b>197-334</b> 5  <b>1-3/16 EXT</b></p>	<p><b>197-338</b> 5  <b>1-5/16 EXT</b></p>	<p><b>197-346</b> 5  <b>1-5/8 EXT</b></p>
<p><b>197-308</b> 20  <b>5/16 EXT</b></p>	<p><b>197-320</b> 15  <b>9/16 EXT</b></p>	<p><b>197-325</b> 10  <b>13/16 EXT</b></p>	<p><b>197-332</b> 5  <b>1-1/8 EXT</b></p>		<p><b>197-344</b> 5  <b>1-1/2 EXT</b></p>
<p><b>197-306</b> 20  <b>1/4 EXT</b></p>	<p><b>197-316</b> 15  <b>1/2 EXT</b></p>	<p><b>197-324</b> 10  <b>3/4 EXT</b></p>	<p><b>197-330</b> 5  <b>1-1/16 EXT</b></p>		<p><b>197-342</b> 5  <b>1-7/16 EXT</b></p>



**PART # 0198-25**

**ASSORTMENT: O-RINGS**

01/22

































<p>198-114 <sup>10</sup></p>  <p>114</p> <p>5/8 X 13/16</p>	<p>198-115 <sup>10</sup></p>  <p>115</p> <p>11/16 X 7/8</p>	<p>198-116 <sup>10</sup></p>  <p>116</p> <p>3/4 X 15/16</p>	<p>198-117 <sup>10</sup></p>  <p>117</p> <p>13/16 X 1"</p>	<p>198-118 <sup>10</sup></p>  <p>118</p> <p>7/8 X 1-1/16</p>	<p>198-119 <sup>10</sup></p>  <p>119</p> <p>15/16 X 1-1/8</p>	<p>198-120 <sup>10</sup></p>  <p>120</p> <p>1" X 1-3/16</p>	<p>198-121 <sup>10</sup></p>  <p>121</p> <p>1-1/16 X 1-1/4</p>
<p>198-030 <sup>5</sup></p>  <p>030</p> <p>1-5/8 X 1-3/4</p>	<p>198-031 <sup>5</sup></p>  <p>031</p> <p>1-3/4 X 1-7/8</p>	<p>198-032 <sup>5</sup></p>  <p>032</p> <p>1-7/8 X 2"</p>		<p>198-110 <sup>10</sup></p>  <p>110</p> <p>3/8 X 9/16</p>	<p>198-111 <sup>10</sup></p>  <p>111</p> <p>7/16 X 5/8</p>	<p>198-112 <sup>10</sup></p>  <p>112</p> <p>1/2 X 11/16</p>	<p>198-113 <sup>10</sup></p>  <p>113</p> <p>9/16 X 3/4</p>
<p>198-019 <sup>10</sup></p>  <p>019</p> <p>13/16 X 15/16</p>	<p>198-020 <sup>10</sup></p>  <p>020</p> <p>7/8 X 1"</p>	<p>198-021 <sup>10</sup></p>  <p>021</p> <p>15/16 X 1-1/16</p>	<p>198-022 <sup>10</sup></p>  <p>022</p> <p>1" X 1-1/8</p>	<p>198-024 <sup>10</sup></p>  <p>024</p> <p>1-1/8 X 1-1/4</p>	<p>198-026 <sup>10</sup></p>  <p>026</p> <p>1-1/4 X 1-3/8</p>	<p>198-028 <sup>10</sup></p>  <p>028</p> <p>1-3/8 X 1-1/2</p>	<p>198-029 <sup>10</sup></p>  <p>029</p> <p>1-1/2 X 1-5/8</p>
<p>198-006 <sup>10</sup></p>  <p>006</p> <p>1/8 X 1/4</p>	<p>198-007 <sup>10</sup></p>  <p>007</p> <p>5/32 X 9/32</p>	<p>198-008 <sup>10</sup></p>  <p>008</p> <p>3/16 X 5/16</p>	<p>198-009 <sup>10</sup></p>  <p>009</p> <p>7/32 X 11/32</p>	<p>198-010 <sup>10</sup></p>  <p>010</p> <p>1/4 X 3/8</p>	<p>198-011 <sup>10</sup></p>  <p>011</p> <p>5/16 X 7/16</p>	<p>198-012 <sup>10</sup></p>  <p>012</p> <p>3/8 X 1/2</p>	<p>198-013 <sup>10</sup></p>  <p>013</p> <p>7/16 X 9/16</p>



**PART # 0198-35**

**ASSORTMENT: O-RINGS #1**

01/22

198-110 <sup>10</sup>  110 3/8 X 9/16	198-111 <sup>10</sup>  111 7/16 X 5/8	198-112 <sup>10</sup>  112 1/2 X 11/16	198-113 <sup>10</sup>  113 9/16 X 3/4	198-114 <sup>10</sup>  114 5/8 X 13/16	198-115 <sup>10</sup>  115 11/16 X 7/8	198-116 <sup>10</sup>  116 3/4 X 15/16	198-117 <sup>10</sup>  117 13/16 X 1
198-022 <sup>10</sup>  022 1 X 1-1/8	198-024 <sup>10</sup>  024 1-1/8 X 1-1/4	198-026 <sup>10</sup>  026 1-1/4 X 1-3/8	198-028 <sup>10</sup>  028 1-3/8 X 1-1/2	198-029 <sup>10</sup>  029 1-1/2 X 1-5/8	198-030 <sup>5</sup>  030 1-5/8 X 1-3/4	198-031 <sup>5</sup>  031 1-3/4 X 1-7/8	198-032 <sup>5</sup>  032 1-7/8 X 2
198-014 <sup>10</sup>  014 1/2 X 5/8	198-015 <sup>10</sup>  015 9/16 X 11/16	198-016 <sup>10</sup>  016 5/8 X 3/4	198-017 <sup>10</sup>  017 11/16 X 13/16	198-018 <sup>10</sup>  018 3/4 X 7/8	198-019 <sup>10</sup>  019 13/16 X 15/16	198-020 <sup>10</sup>  020 7/8 X 1	198-021 <sup>10</sup>  021 15/16 X 1-1/16
198-006 <sup>10</sup>  006 1/8 X 1/4	198-007 <sup>10</sup>  007 5/32 X 9/32	198-008 <sup>10</sup>  008 3/16 X 5/16	198-009 <sup>10</sup>  009 7/32 X 11/32	198-010 <sup>10</sup>  010 1/4 X 3/8	198-011 <sup>10</sup>  011 5/16 X 7/16	198-012 <sup>10</sup>  012 3/8 X 1/2	198-013 <sup>10</sup>  013 7/16 X 9/16



**CANTON FLEET - INDUSTRIAL SUPPLY**  
**COLUMBUS FLEET - INDUSTRIAL SUPPLY**

































WWW.cfisgroup.com

(614) 332-7464

PART # 0198-45

**ASSORTMENT: O-RINGS #2**

01/22

198-220 <sup>5</sup>  220 1-3/8 X 1-5/8	198-221 <sup>5</sup>  221 1-7/16 X 1-11/16	198-222 <sup>5</sup>  222 1-1/2 X 1-3/4	198-223 <sup>5</sup>  223 1-5/8 X 1-7/8	198-224 <sup>5</sup>  224 1-3/4 X 2	198-225 <sup>5</sup>  225 1-7/8 X 2-1/8	198-226 <sup>5</sup>  226 2 X 2-1/4	198-227 <sup>5</sup>  227 2-1/8 X 2-3/8
198-212 <sup>10</sup>  212 7/8 X 1-1/8	198-213 <sup>10</sup>  213 15/16 X 1-3/16	198-214 <sup>10</sup>  214 1 X 1-1/4	198-215 <sup>10</sup>  215 1-1/16 X 1-5/16	198-216 <sup>5</sup>  216 1-1/8 X 1-3/8	198-217 <sup>5</sup>  217 1-3/16 X 1-7/16	198-218 <sup>5</sup>  218 1-1/4 X 1-1/2	198-219 <sup>5</sup>  219 1-5/16 X 1-9/16
198-128 <sup>5</sup>  128 1-1/2 X 1-11/16	198-130 <sup>5</sup>  130 1-5/8 X 1-13/16	198-132 <sup>5</sup>  132 1-3/4 X 1-15/16	198-134 <sup>5</sup>  134 1-7/8 X 2-1/16	198-136 <sup>5</sup>  146 2 X 2-3/16	198-209 <sup>10</sup>  209 11/16 X 15/16	198-210 <sup>10</sup>  210 3/4 X 1	198-211 <sup>10</sup>  211 13/16 X 1-1/16
198-118 <sup>10</sup>  118 7/8 X 1-1/16	198-119 <sup>10</sup>  119 15/16 X 1-1/8	198-120 <sup>10</sup>  120 1 X 1-3/16	198-121 <sup>10</sup>  121 1-1/16 X 1-1/4	198-122 <sup>10</sup>  122 1-1/8 X 1-5/16	198-123 <sup>10</sup>  123 1-3/16 X 1-3/8	198-124 <sup>10</sup>  124 1-1/4 X 1-7/16	198-126 <sup>10</sup>  126 1-3/8 X 1-9/16

PART # 0198-55

# ASSORTMENT: O-RINGS #3

01/22

198-335

5



335

2-3/4 X 3-1/8

198-336

5



336

2-7/8 X 3-1/4

198-337

5



337

3 X 3-3/8

198-331

5



331

2-1/4 X 2-5/8

198-332

5



332

2-3/8 X 2-3/4

198-333

5



333

2-1/2 X 2-7/8

198-334

5



334

2-5/8 X 3

198-327

5



327

1-3/4 X 2-1/8

198-328

5



328

1-7/8 X 2-1/4

198-329

5



329

2 X 2-3/8

198-330

5



330

2-1/8 X 2-1/2

198-228

5



228

2-1/4 X 2-1/2

198-325

5



325

1-1/2 X 1-7/8

198-326

5



326

























1-5/8 X 2



**PART # 0198-75**

**ASSORTMENT: METRIC O-RINGS #1**

01/22











<p>198-760 10</p>  <p>14 X 19</p> <p>14 X 2.5</p>	<p>198-764 10</p>  <p>16 X 21</p> <p>16 X 2.5</p>	<p>198-768 10</p>  <p>17 X 22</p> <p>17 X 2.5</p>	<p>198-772 10</p>  <p>19 X 24</p> <p>19 X 2.5</p>	<p>198-840 5</p>  <p>19 X 25</p> <p>19 X 3.0</p>	<p>198-844 5</p>  <p>20 X 26</p> <p>20 X 3.0</p>
<p>198-726 10</p>  <p>14 X 18</p> <p>14 X 2.0</p>	<p>198-740 10</p>  <p>28 X 32</p> <p>28 X 2.0</p>	<p>198-750 10</p>  <p>10 X 15</p> <p>10 X 2.5</p>	<p>198-754 10</p>  <p>11 X 16</p> <p>11 X 2.5</p>	<p>198-758 10</p>  <p>12 X 17</p> <p>12 X 2.5</p>	<p>198-848 5</p>  <p>22 X 28</p> <p>22 X 3.0</p>
<p>198-716 10</p>  <p>8 X 12</p> <p>8 X 2.0</p>	<p>198-718 10</p>  <p>9 X 13</p> <p>9 X 2.0</p>	<p>198-720 10</p>  <p>10 X 14</p> <p>10 X 2.0</p>	<p>198-722 10</p>  <p>11 X 15</p> <p>11 X 2.0</p>	<p>198-724 10</p>  <p>12 X 16</p> <p>12 X 2.0</p>	<p>198-852 5</p>  <p>24 X 30</p> <p>24 X 3.0</p>
<p>198-706 10</p>  <p>3 X 7</p> <p>3 X 2.0</p>	<p>198-708 10</p>  <p>4 X 8</p> <p>4 X 2.0</p>	<p>198-710 10</p>  <p>5 X 9</p> <p>5 X 2.0</p>	<p>198-712 10</p>  <p>6 X 10</p> <p>6 X 2.0</p>	<p>198-714 10</p>  <p>7 X 11</p> <p>7 X 2.0</p>	<p>198-856 5</p>  <p>25 X 31</p> <p>25 X 3.0</p>



**PART # 0198-80**

**ASSORTMENT: METRIC O-RINGS #2**

01/22



























<p><b>198-948</b></p>  <p><b>44 X 52</b></p> <p><b>44 X 4.0</b></p>					
<p><b>198-878 10</b></p>  <p><b>35 X 41</b></p> <p><b>35 X 3.0</b></p>	<p><b>198-880 10</b></p>  <p><b>36 X 42</b></p> <p><b>36 X 3.0</b></p>	<p><b>198-882 10</b></p>  <p><b>38 X 44</b></p> <p><b>38 X 3.0</b></p>	<p><b>198-940 10</b></p>  <p><b>38 X 46</b></p> <p><b>38 X 4.0</b></p>	<p><b>198-944 10</b></p>  <p><b>41 X 49</b></p> <p><b>41 X 4.0</b></p>	
<p><b>198-860 10</b></p>  <p><b>27 X 33</b></p> <p><b>27 X 3.0</b></p>	<p><b>198-864 10</b></p>  <p><b>28 X 34</b></p> <p><b>28 X 3.0</b></p>	<p><b>198-868 10</b></p>  <p><b>30 X 36</b></p> <p><b>30 X 3.0</b></p>	<p><b>198-872 10</b></p>  <p><b>32 X 38</b></p> <p><b>32 X 3.0</b></p>	<p><b>198-876 10</b></p>  <p><b>33 X 39</b></p> <p><b>33 X 3.0</b></p>	

PART # 0198-90

**ASSORTMENT: QUAD O-RINGS**



01/22

<p>198-666 <sup>10</sup></p>  <p>219</p> <p>1/8"</p> <p>15/16 X 1-9/16</p>	<p>198-668 <sup>10</sup></p>  <p>220</p> <p>1/8"</p> <p>1-3/8 X 1-5/8</p>	<p>198-670 <sup>10</sup></p>  <p>221</p> <p>1/8"</p> <p>1-7/16 X 1-11/16</p>					
<p>198-650 <sup>10</sup></p>  <p>211</p> <p>1/8"</p> <p>13/16 X 1-1/16</p>	<p>198-652 <sup>10</sup></p>  <p>212</p> <p>1/8"</p> <p>7/8 X 1-1/8</p>	<p>198-654 <sup>10</sup></p>  <p>213</p> <p>1/8"</p> <p>15/16 X 1-3/16</p>	<p>198-656 <sup>10</sup></p>  <p>214</p> <p>1/8"</p> <p>1" X 1-1/4</p>	<p>198-658 <sup>10</sup></p>  <p>215</p> <p>1/8"</p> <p>1-1/16 X 1-1-5/16</p>	<p>198-660 <sup>10</sup></p>  <p>216</p> <p>1/8"</p> <p>1-1/8 X 1-3/8</p>	<p>198-662 <sup>10</sup></p>  <p>217</p> <p>1/8"</p> <p>1-3/16 X 1-7/16</p>	<p>198-664 <sup>10</sup></p>  <p>218</p> <p>1/8"</p> <p>1-1/4 X 1-1/2</p>
<p>198-612 <sup>10</sup></p>  <p>112</p> <p>3/32"</p> <p>1/2 X 11/16</p>	<p>198-613 <sup>10</sup></p>  <p>113</p> <p>3/32"</p> <p>9/16 X 3/4</p>	<p>198-614 <sup>10</sup></p>  <p>114</p> <p>3/32"</p> <p>5/8 X 13/16</p>	<p>198-615 <sup>10</sup></p>  <p>115</p> <p>3/32"</p> <p>11/16 X 7/8</p>	<p>198-616 <sup>10</sup></p>  <p>116</p> <p>3/32"</p> <p>3/4 X 15/16</p>	<p>198-617 <sup>10</sup></p>  <p>117</p> <p>3/32"</p> <p>13/16 X 1"</p>	<p>198-618 <sup>10</sup></p>  <p>118</p> <p>3/32"</p> <p>7/8 X 1-1/16</p>	<p>198-648 <sup>10</sup></p>  <p>210</p> <p>1/8"</p> <p>3/4 X 1"</p>
<p>198-506 <sup>10</sup></p>  <p>006</p> <p>1/16"</p> <p>1/8 X 1/4</p>	<p>198-508 <sup>10</sup></p>  <p>008</p> <p>1/16"</p> <p>3/16 X 5/16</p>	<p>198-510 <sup>10</sup></p>  <p>010</p> <p>1/16"</p> <p>1/4 X 3/8</p>	<p>198-511 <sup>10</sup></p>  <p>011</p> <p>1/16"</p> <p>5/16 X 7/16</p>	<p>198-512 <sup>10</sup></p>  <p>012</p> <p>1/16"</p> <p>3/8 X 1/2</p>	<p>198-514 <sup>10</sup></p>  <p>014</p> <p>1/16"</p> <p>1/2 X 5/8</p>	<p>198-610 <sup>10</sup></p>  <p>110</p> <p>3/32"</p> <p>3/8 X 9/16</p>	<p>198-611 <sup>10</sup></p>  <p>111</p> <p>3/32"</p> <p>7/16 X 5/8</p>



**CANTON FLEET - INDUSTRIAL SUPPLY**  
**COLUMBUS FLEET - INDUSTRIAL SUPPLY**

WWW.cfisgroup.com

(614) 332-7464

**PART # 0199-25 / 199-50**

# **ASSORTMENT: 12" KEY STOCK**

01/22

**PART # 0199-25 SQUARE STOCK**

















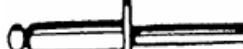





**PART # 0199-50 FLAT STOCK**



**PART # 0201-25**

**ASSORTMENT: POP RIVETS**

01/22

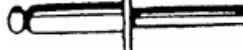
<p>201-132 25</p>  <p>3/16" STEEL 6-2</p>	<p>201-134 25</p>  <p>3/16" STEEL 6-4</p>	<p>201-136 25</p>  <p>3/16" STEEL 6-6</p>	<p>201-138 25</p>  <p>3/16" STEEL 6-8</p>	<p>201-280 25</p>  <p>1/4 X 3/4 PEEL RIVITS</p>	<p>201-238 25</p>  <p>STEEL 3/16" LARGE FLANGE 6-8</p>
<p>201-034 25</p>  <p>3/16" ALUM 6-4</p>	<p>201-035 25</p>  <p>3/16" ALUM 6-6</p>	<p>201-036 25</p>  <p>3/16" ALUM 6-8</p>		<p>201-278 25</p>  <p>1/4 X 5/16 PEEL RIVITS</p>	<p>201-212 25</p>  <p>ALUMINUM 3/16" LARGE FLANGE 6-10</p>
<p>201-012 25</p>  <p>1/8" STEEL 4-2</p>	<p>201-014 25</p>  <p>1/8" STEEL 4-4</p>		<p>201-018 25</p>  <p>1/8" STEEL 4-6</p>	<p>201-020 25</p>  <p>1/8" STEEL 4-8</p>	<p>201-208 25</p>  <p>ALUMINUM 3/16" LARGE FLANGE 6-8</p>
<p>201-002 25</p>  <p>1/8" ALUM 4-2</p>	<p>201-004 25</p>  <p>1/8" ALUM 4-4</p>	<p>201-006 25</p>  <p>1/8" ALUM 4-5</p>	<p>201-008 25</p>  <p>1/8" ALUM 4-6</p>	<p>201-010 25</p>  <p>1/8" ALUM 4-8</p>	<p>201-206 25</p>  <p>ALUMINUM 3/16" LARGE FLANGE 6-6</p>



**CANTON FLEET - INDUSTRIAL SUPPLY**  
**COLUMBUS FLEET - INDUSTRIAL SUPPLY**











WWW.cfisgroup.com

(614) 332-7464

PART # 0203-25

# ASSORTMENT: NUTSERTS

01/22

<p><b>203-016</b> 25</p>  <p>5 X .70</p>	<p><b>203-020</b> 25</p>  <p>6 X .80</p>	<p><b>203-022</b> 10</p>  <p>8 X 1.25</p>	<p><b>203-024</b> 10</p>  <p>10 X 1.50</p>	<p><b>203-012</b> 10</p>  <p>3/8-16</p>	
<p><b>203-001</b> 25</p>  <p>6-32</p>	<p><b>203-002</b> 25</p>  <p>8-32</p>	<p><b>203-004</b> 25</p>  <p>10-24</p>	<p><b>203-006</b> 25</p>  <p>10-32</p>	<p><b>203-008</b> 25</p>  <p>1/4-20</p>	<p><b>203-010</b> 10</p>  <p>5/16-18</p>



**CANTON FLEET - INDUSTRIAL SUPPLY**  
**COLUMBUS FLEET - INDUSTRIAL SUPPLY**







WWW.cfisgroup.com

(614) 332-7464

PART # 0203-27

# ASSORTMENT: NUTSERTS

01/22













			<p>203-010 10</p>  <p>5/16-18</p>	<p>203-012 10</p>  <p>3/8-16</p>	
<p>203-001 25</p>  <p>6-32</p>	<p>203-002 25</p>  <p>8-32</p>	<p>203-004 25</p>  <p>10-24</p>	<p>203-006 25</p>  <p>10-32</p>	<p>203-008 25</p>  <p>1/4-20</p>	



**PART # 0203-50**

# ASSORTMENT: WELL NUTS

























01/22

<p><b>203-224 10</b></p>  <p><b>6 X 1.00 X .630</b></p>	<p><b>203-228 10</b></p>  <p><b>6 X 1.00 X .625</b></p>	<p><b>203-238 10</b></p>  <p><b>8 X 1.25 X .750</b></p>			
<p><b>203-162 10</b></p>  <p><b>1/4-20 X .625</b></p>	<p><b>203-175 10</b></p>  <p><b>1/4-20 X .740</b></p>	<p><b>203-180 10</b></p>  <p><b>5/16-18 X .875</b></p>		<p><b>203-160 10</b></p>  <p><b>10-32 X .750</b></p>	
<p><b>203-135 10</b></p>  <p><b>6-32 X .452</b></p>	<p><b>203-140 10</b></p>  <p><b>8-32 X .750</b></p>	<p><b>203-145 10</b></p>  <p><b>10-24 X .562</b></p>	<p><b>203-150 10</b></p>  <p><b>10-32 X .500</b></p>	<p><b>203-155 10</b></p>  <p><b>10-32 X .562</b></p>	

PART # 0216-25

**ASSORTMENT: CONCRETE SCREWS**















01/22

<p>216-670 10</p>  <p>FLAT HEAD 1/4 X 1-1/4</p>	<p>216-674 10</p>  <p>FLAT HEAD 1/4 X 1-3/4</p>	<p>216-678 10</p>  <p>FLAT HEAD 1/4 X 2-1/4</p>	<p>216-682 10</p>  <p>FLAT HEAD 1/4 X 2-3/4</p>	<p>216-686 10</p>  <p>FLAT HEAD 1/4 X 3-1/4</p>	<p>216-694 10</p>  <p>FLAT HEAD 1/4 X 4</p>
<p>216-630 10</p>  <p>FLAT HEAD 3/16 X 1-1/4</p>	<p>216-634 10</p>  <p>FLAT HEAD 3/16 X 1-3/4</p>	<p>216-638 10</p>  <p>FLAT HEAD 3/16 X 2-1/4</p>	<p>216-642 10</p>  <p>FLAT HEAD 3/16 X 2-3/4</p>	<p>216-646 10</p>  <p>FLAT HEAD 3/16 X 3-1/4</p>	<p>216-654 10</p>  <p>FLAT HEAD 3/16 X 4</p>
<p>216-570 10</p>  <p>HEX HEAD 1/4 X 1-1/4</p>	<p>216-574 10</p>  <p>HEX HEAD 1/4 X 1-3/4</p>	<p>216-578 10</p>  <p>HEX HEAD 1/4 X 2-1/4</p>	<p>216-582 10</p>  <p>HEX HEAD 1/4 X 2-3/4</p>	<p>216-586 10</p>  <p>HEX HEAD 1/4 X 3-1/4</p>	<p>216-594 10</p>  <p>HEX HEAD 1/4 X 4</p>
<p>216-530 10</p>  <p>HEX HEAD 3/16 X 1-1/4</p>	<p>216-534 10</p>  <p>HEX HEAD 3/16 X 1-3/4</p>	<p>216-538 10</p>  <p>HEX HEAD 3/16 X 2-1/4</p>	<p>216-542 10</p>  <p>HEX HEAD 3/16 X 2-3/4</p>	<p>216-546 10</p>  <p>HEX HEAD 3/16 X 3-1/4</p>	<p>216-554 10</p>  <p>HEX HEAD 3/16 X 4</p>

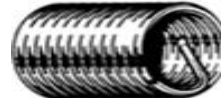
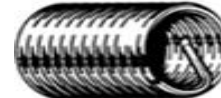
PART # 0204-25

**ASSORTMENT: HELI-COILS**



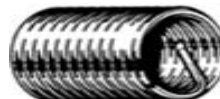











01/22

<p>204-511 5</p>  <p>9/16-12</p>	<p>204-512 5</p>  <p>5/8-11</p>	<p>204-514 5</p>  <p>3/4-10</p>	<p>204-516 5</p>  <p>7/8-9</p>	<p>204-518 5</p>  <p>1-8</p>	<p>204-538 5</p>  <p>7/16-20</p>
	<p>204-504 5</p>  <p>1/4-20</p>	<p>204-506 5</p>  <p>5/16-18</p>	<p>204-507 5</p>  <p>3/8-16</p>	<p>204-508 5</p>  <p>7/16-14</p>	<p>204-510 5</p>  <p>1/2-13</p>
	<p>204-628 5</p>  <p>6MM X 1.00</p>	<p>204-632 5</p>  <p>8MM X 1.25</p>	<p>204-636 5</p>  <p>10MM X 1.50</p>	<p>204-640 5</p>  <p>12MM X 1.75</p>	<p>204-644 5</p>  <p>14MM X 2.00</p>

PART # 0204-45

# ASSORTMENT: KEENSERTS

01/22

<p><b>204-828</b></p>  <p>4</p> <p><b>3/8-16</b> 29/64 DRILL 1/2-13 TAP</p>	<p><b>204-830</b></p>  <p>4</p> <p><b>3/8-24</b> 29/64 DRILL 1/2-13 TAP</p>	<p><b>204-846</b></p>  <p>2</p> <p><b>5/8-11</b> 53/64 DRILL 7/8-14 TAP</p>	<p><b>204-847</b></p>  <p>2</p> <p><b>5/8-18</b> 53/64 DRILL 7/8-14 TAP</p>	
<p><b>204-824</b></p>  <p>4</p> <p><b>5/16-18</b> X DRILL 7/16-14 TAP</p>	<p><b>204-85426</b></p>  <p>4</p> <p><b>5/16-24</b> X DRILL 7/16-14 TAP</p>			
<p><b>204-820</b></p>  <p>4</p> <p><b>1/4-20</b> Q DRILL 3/8-16 TAP</p>	<p><b>204-822</b></p>  <p>4</p> <p><b>1/4-28</b> Q DRILL 3/8-16 TAP</p>	<p><b>204-836</b></p>  <p>4</p> <p><b>1/2-13</b> 37/64 DRILL 5/8-11 TAP</p>	<p><b>204-838</b></p>  <p>4</p> <p><b>1/2-20</b> 37/64 DRILL 5/8-11 TAP</p>	
<p><b>204-812</b></p>  <p>4</p> <p><b>10-24</b> T DRILL 5/16-18 TAP</p>	<p><b>204-816</b></p>  <p>4</p> <p><b>10-32</b> T DRILL 5/16-18 TAP</p>	<p><b>204-832</b></p>  <p>4</p> <p><b>7/16-14</b> 33/64 DRILL 9/16-12 TAP</p>	<p><b>204-834</b></p>  <p>4</p> <p><b>7/16-20</b> 33/64 DRILL 9/16-12 TAP</p>	

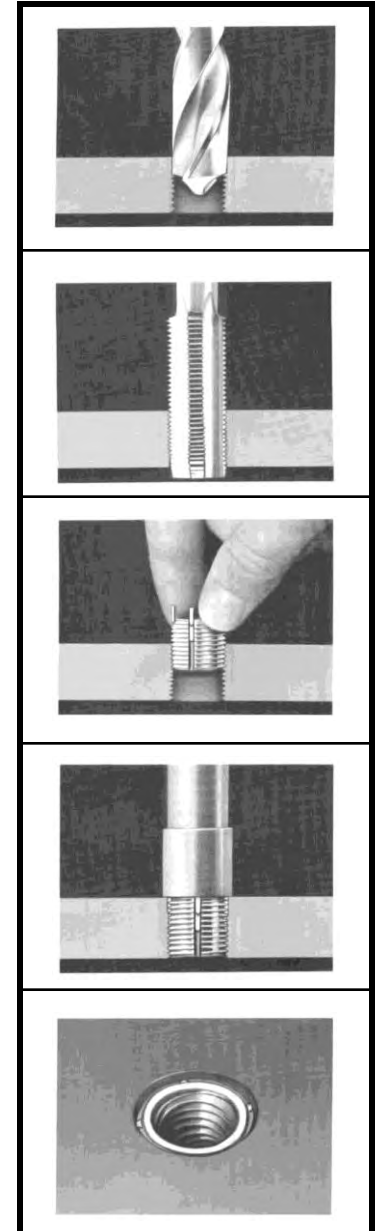

PART # 0347-25

**ASSORTMENT: HAND TAPS**

01/22

<p>347-720</p>  <p>1/8 PIPE TAP</p>	<p>347-722</p>  <p>1/4 PIPE TAP</p>	<p>347-724</p>  <p>3/8 PIPE TAP</p>	<p>347-726</p>  <p>1/2 PIPE TAP</p>	<p>347-728</p>  <p>3/4 PIPE TAP</p>	<p>347-504</p>  <p>1/4-1/2 T-TYPE TAP WRENCH</p> <p>347-502</p>  <p>6-32-1/4 T-TYPE TAP WRENCH</p>
<p>347-354</p>  <p>3/8-16</p>					
<p>347-351 TAP</p>  <p>5/16-18</p>	<p>347-357</p>  <p>7/16-14 TAP</p>	<p>347-360</p>  <p>1/2-13 TAP</p>	<p>347-366</p>  <p>5/8-11 TAP</p>	<p>347-369</p>  <p>3/4-10 TAP</p>	
<p>347-332 TAP</p>  <p>6-32</p>	<p>347-335 TAP</p>  <p>8-32</p>	<p>347-338 TAP</p>  <p>10-24</p>	<p>347-341 TAP</p>  <p>10-32</p>	<p>347-348 TAP</p>  <p>1/4-20</p>	

PART # 0347-35

# ASSORTMENT: TAPS & DIES

01/22

<p><b>347-720</b></p>  <p><b>1/8 PIPE TAP</b></p>	<p><b>347-722</b></p>  <p><b>1/4 PIPE TAP</b></p>	<p><b>347-724</b></p>  <p><b>3/8 PIPE TAP</b></p>	<p><b>347-726</b></p>  <p><b>1/2 PIPE TAP</b></p>	<p><b>347-728</b></p>  <p><b>3/4 PIPE TAP</b></p>	<p><b>348-804</b></p>  <p><b>9/16-3/4 HEX DIE STOCK</b></p>	<p><b>348-802</b></p>  <p><b>6-32-1/2 HEX DIE STOCK</b></p>
<p><b>347-354</b></p>  <p><b>348-824 HEX DIE</b></p>  <p><b>3/8-16</b></p>	<p><b>348-826</b></p>  <p><b>7/16-14 HEX DIE</b></p>	<p><b>348-828</b></p>  <p><b>1/2-13 HEX DIE</b></p>	<p><b>348-834</b></p>  <p><b>5/8-11 HEX DIE</b></p>	<p><b>348-836</b></p>  <p><b>3/4-10 HEX DIE</b></p>		
<p><b>347-351 TAP</b></p>  <p><b>348-822 HEX DIE</b></p>  <p><b>5/16-18</b></p>	<p><b>347-357</b></p>  <p><b>7/16-14 TAP</b></p>	<p><b>347-360</b></p>  <p><b>1/2-13 TAP</b></p>	<p><b>347-366</b></p>  <p><b>5/8-11 TAP</b></p>	<p><b>347-369</b></p>  <p><b>3/4-10 TAP</b></p>	<p><b>347-504</b></p>  <p><b>1/4-1/2 T-TYPE TAP WRENCH</b></p>	
<p><b>347-332 TAP</b></p>  <p><b>348-812 HEX DIE</b></p>  <p><b>6-32</b></p>	<p><b>347-335 TAP</b></p>  <p><b>348-814 HEX DIE</b></p>  <p><b>8-32</b></p>	<p><b>347-338 TAP</b></p>  <p><b>348-816 HEX DIE</b></p>  <p><b>10-24</b></p>	<p><b>347-341 TAP</b></p>  <p><b>348-818 HEX DIE</b></p>  <p><b>10-32</b></p>	<p><b>347-348 TAP</b></p>  <p><b>348-820 HEX DIE</b></p>  <p><b>1/4-20</b></p>	<p><b>347-502</b></p>  <p><b>6-32-1/4 T-TYPE TAP WRENCH</b></p>	

PART # 0358-25

# ASSORTMENT: HOLE SAWS

01/22



**PART # 0360-25**

**ASSORTMENT: SANDING / GASKET DISC**

01/22

**360-142**

10



**360-140**

10



**360-034**

10



**360-036**

10



**3" X 24 GRIT SANDING DISC**

**3" X 36 GRIT SANDING DISC**

**3" MEDIUM PADS**

**3" COARSE PADS**

**360-111**

10



**360-109**

10



**360-023**

10



**360-026**

10



**2" X 24 GRIT SANDING DISC**

**2" X 36 GRIT SANDING DISC**

**2" MEDIUM PADS**

**2" COARSE PADS**

PART # 0360-27

# ASSORTMENT: SANDING / GASKET DISC

01/22

360-034

10



3" X 24 GRIT SANDING DISC

360-036

10



3" X 36 GRIT SANDING DISC

360-023

10



2" MEDIUM PADS

360-026

10



2" COARSE PADS

360-111

10



2" X 24 GRIT SANDING DISC

360-109

10



2" X 36 GRIT SANDING DISC

360-002

EA



2" ARBOR

360-003

EA



3" ARBOR

PART # 0360-30

**ASSORTMENT: FLAP WHEELS / DISC**

01/22



361-418

EA

2" x 120g

Mini-Fap  
Disc

365-146



2" x 80g mini-flap disc



365-148

EA

2" x 120g Flap Wheel



361-440

EA

3" x 120g Mini-Fap Disc



365-188

EA

3" x 120g Flap Wheel



361-416

EA

2" x 80g

Mini-Fap  
Disc

365-126



1" x 120g mini-flap disc



365-138

EA

1-1/2" x 120g Flap Wheel



361-435

EA

3" x 80g Mini-Fap Disc

365-186

EA



3" x 80g Flap Wheel



361-414

EA

2" x 60g

Mini-Fap  
Disc

365-124



1" x 80g mini-flap disc



365-136

EA

1-1/2" x 80g Flap Wheel



361-430

EA

3" x 60g Mini-Fap Disc

PART # 0360-40

**ASSORTMENT: WHEELS / DISC**

01/22

361-514

EA



3" Black Disc

361-504

EA



3" Red Disc

361-625

EA



3" Purple Disc

361-204

EA



3" x 80g Ceramic Disc

361-510

2



2" Black Disc

361-502

2



2" Red Disc

361-620

2



2" Purple Disc

361-202

EA



3" x 60g Ceramic Disc

361-425

EA



3" x 40g  
Mini-Fap  
Disc

2

361-412



2" x 40g mini-flap disc

361-430

EA



3" x 60g  
Mini-Fap  
Disc

2

361-414



2" x 60g mini-flap disc

361-435

EA



3" x 80g  
Mini-Fap  
Disc

2

361-416



2" x 80g mini-flap disc

361-200

EA



3" x 40g Ceramic Disc

**PART # 0364-50**

# ASSORTMENT: WOVEN FLAP WHEELS

01/22

**364-726**



**1" x 180 Grit**

**364-736**



**1-1/2 x 180 Grit**

**364-746**



**2" x 180 Grit**

**364-756**



**3" x 180 Grit**

**364-724**



**1" x 120 Grit**

**364-734**



**1-1/2 x 120 Grit**

**364-744**



**2" x 120 Grit**

**364-754**



**3" x 120 Grit**

**364-722**



**1" x 80 Grit**

**364-732**



**1-1/2 x 80 Grit**

**364-742**

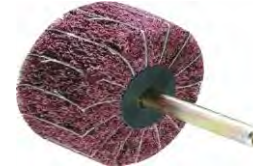

**2" x 80 Grit**

**364-752**



**3" x 80 Grit**

**364-720**



**1" x 60 Grit**

**364-730**



**1-1/2 x 60 Grit**

**364-740**



**2" x 60 Grit**

**364-750**



**3" x 60 Grit**

**PART # 0364-55**

# ASSORTMENT: WOVEN FLAP WHEELS

01/22

**364-726**



**1" x 180 Grit**

**364-736**

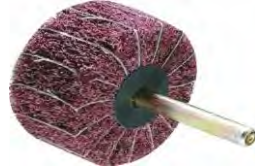

**1-1/2 x 180 Grit**

**364-746**



**2" x 180 Grit**

**364-756**



**3" x 180 Grit**

**364-724**



**1" x 120 Grit**

**364-734**



**1-1/2 x 120 Grit**

**364-744**



**2" x 120 Grit**

**364-754**



**3" x 120 Grit**

**364-722**



**1" x 80 Grit**

**364-732**



**1-1/2 x 80 Grit**

**364-742**



**2" x 80 Grit**

**364-752**



**3" x 80 Grit**

**PART # 0365-50**

# ASSORTMENT: FLAP WHEELS

01/22

**365-128**

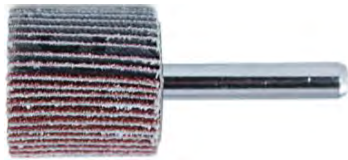

**1" x 180 Grit**

**365-112**



**3/4 x 80 Grit**

**365-150**



**2" x 180 Grit**

**365-188**



**3" x 120 Grit**

**365-126**



**1" x 120 Grit**

**365-138**



**1-1/2 x 120 Grit**

**365-148**



**2" x 120 Grit**

**365-186**



**3" x 80 Grit**

**365-124**



**1" x 80 Grit**

**365-136**



**1-1/2 x 80 Grit**

**365-146**



**2" x 80 Grit**

**365-184**



**3" x 60 Grit**

**365-122**

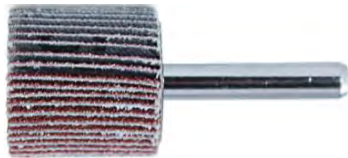

**1" x 60 Grit**

**365-134**



**1-1/2 x 60 Grit**

**365-144**



**2" x 60 Grit**

**365-182**



**3" x 40 Grit**



**PART # 0365-55**

# ASSORTMENT: FLAP WHEELS

01/22

**365-128**

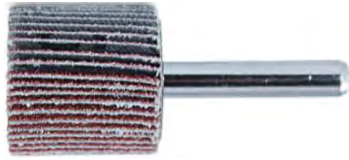

**1" x 180 Grit**

**365-112**



**3/4 x 80 Grit**

**365-150**



**2" x 180 Grit**

**365-188**

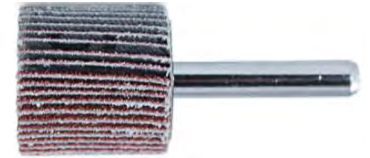

**3" x 120 Grit**

**365-126**

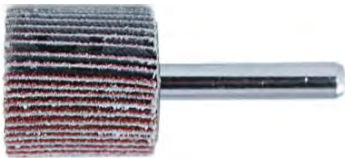

**1" x 120 Grit**

**365-138**



**1-1/2 x 120 Grit**

**365-148**



**2" x 120 Grit**

**365-186**

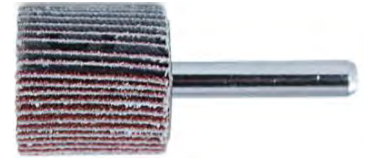

**3" x 80 Grit**

**365-124**



**1" x 80 Grit**

**365-136**



**1-1/2 x 80 Grit**

**365-146**



**2" x 80 Grit**

**365-184**



**3" x 60 Grit**



**CANTON FLEET - INDUSTRIAL SUPPLY**  
**COLUMBUS FLEET - INDUSTRIAL SUPPLY**

WWW.cfisgroup.com

(614) 332-7464

PART # 0367-50

**ASSORTMENT: WIRE POWER BRUSHES**

01/22

368-008



368-010



.014 WIRE

STAINLESS WIRE

368-006



368-012



.012 WIRE

BRASS WIRE

367-578



367-582



1-1/4" X .006

7/8" X .006

367-572



367-576



3/4" X .006

1" X .006

367-564



367-568



5/8" X .005

5/8" X .008

367-552



367-556



367-560



3/8" X .003

1/2" X .004

1/2" X .006

PART # 0367-55

# ASSORTMENT: WIRE BRUSHES

01/22

367-525



3"

367-530



4"

367-476



1-1/2"

367-480



2"

367-482



2-1/2"

367-484



3"

367-422



1/2"

367-424



3/4"

367-426



1"

367-444



3/4"

367-446



1"

367-448



1-1/4"

367-460



3/4" Stainless

367-462



1" Stainless

367-428



1-3/4" Steel

367-430



2" Steel

**PART # 0395-15**

**ASSORTMENT: CLAMPS**

01/22

**395-006**

**5**



**#6 (.44 - .78 HOSE)**

**395-016**

**5**



**#16 (.68 - 1.50 HOSE)**

**395-028**

**5**



**#28 (1.31 - 2.25 HOSE)**

**395-036**

**5**



**#36 (1.81 - 2.75 HOSE)**

**395-006M**

**10**



**Mini clamp**  
**#5 (.31 - .88 HOSE)**

**395-012**

**5**



**#12 (.56 - 1.25 HOSE)**

**395-020**

**5**



**#20 (.75 - 1.75 HOSE)**

**395-032**

**5**



**#32 (1.56 - 2.50 HOSE)**

**395-004M**

**10**



**Mini clamp**  
**#4 (.22 - .63 HOSE)**

**395-010**

**5**



**#10 (.56 - 1.06 HOSE)**



CANTON FLEET - INDUSTRIAL SUPPLY  
COLUMBUS FLEET - INDUSTRIAL SUPPLY

WWW.cfisgroup.com

(614) 332-7464

PART # 0395-25

# ASSORTMENT: HOSE CLAMPS

01/22

ASSORTMENT QUANTITY 10 EA 4,5,8,10,12,20,24,28,32,36

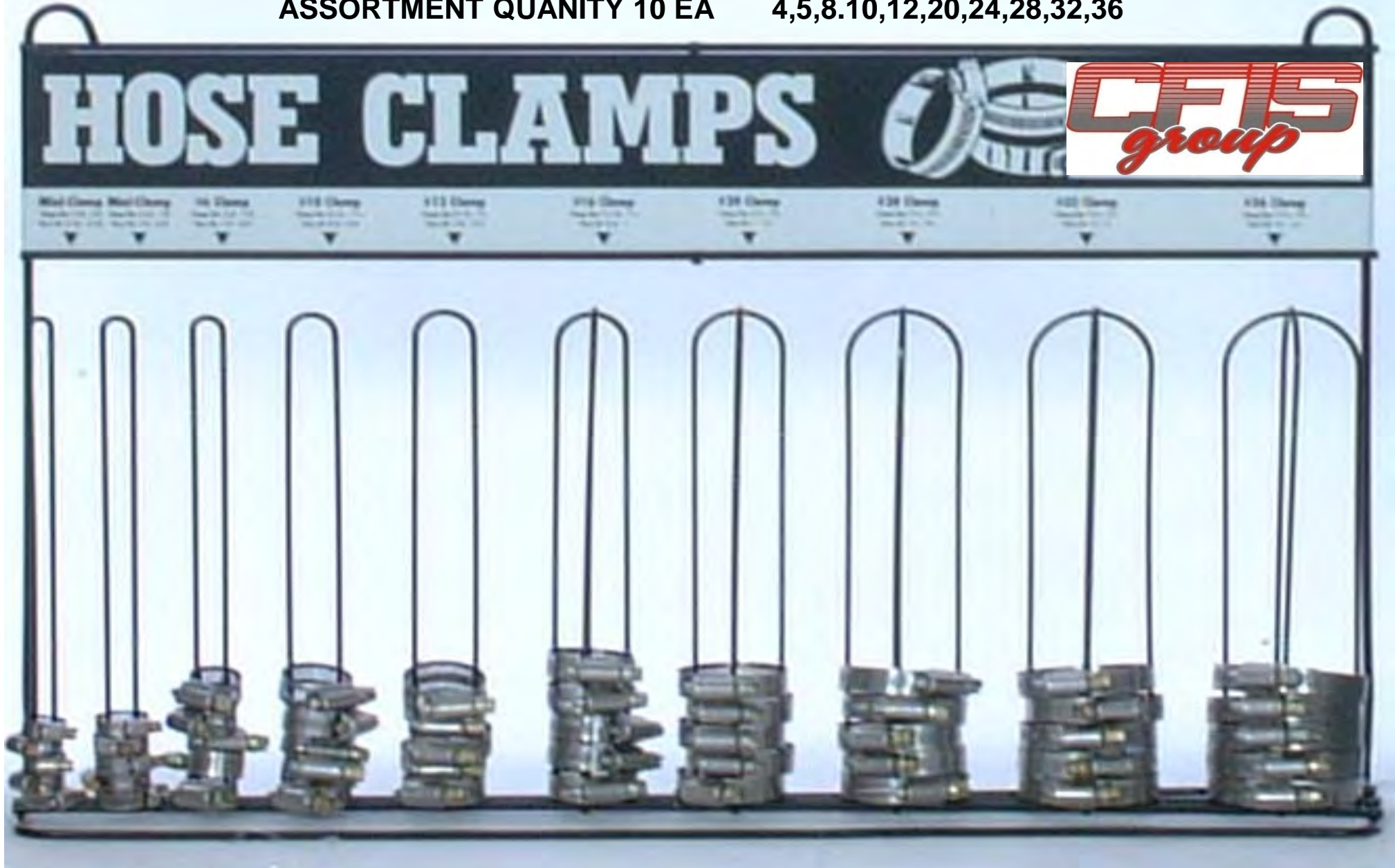



CANTON FLEET - INDUSTRIAL SUPPLY  
COLUMBUS FLEET - INDUSTRIAL SUPPLY

WWW.cfisgroup.com

(614) 332-7464

PART # 0395-35

# ASSORTMENT: LINER HOSE CLAMPS

01/22

ASSORTMENT QUANTITY 5 EA 4,5,8,10,12,20,24,28,32,36

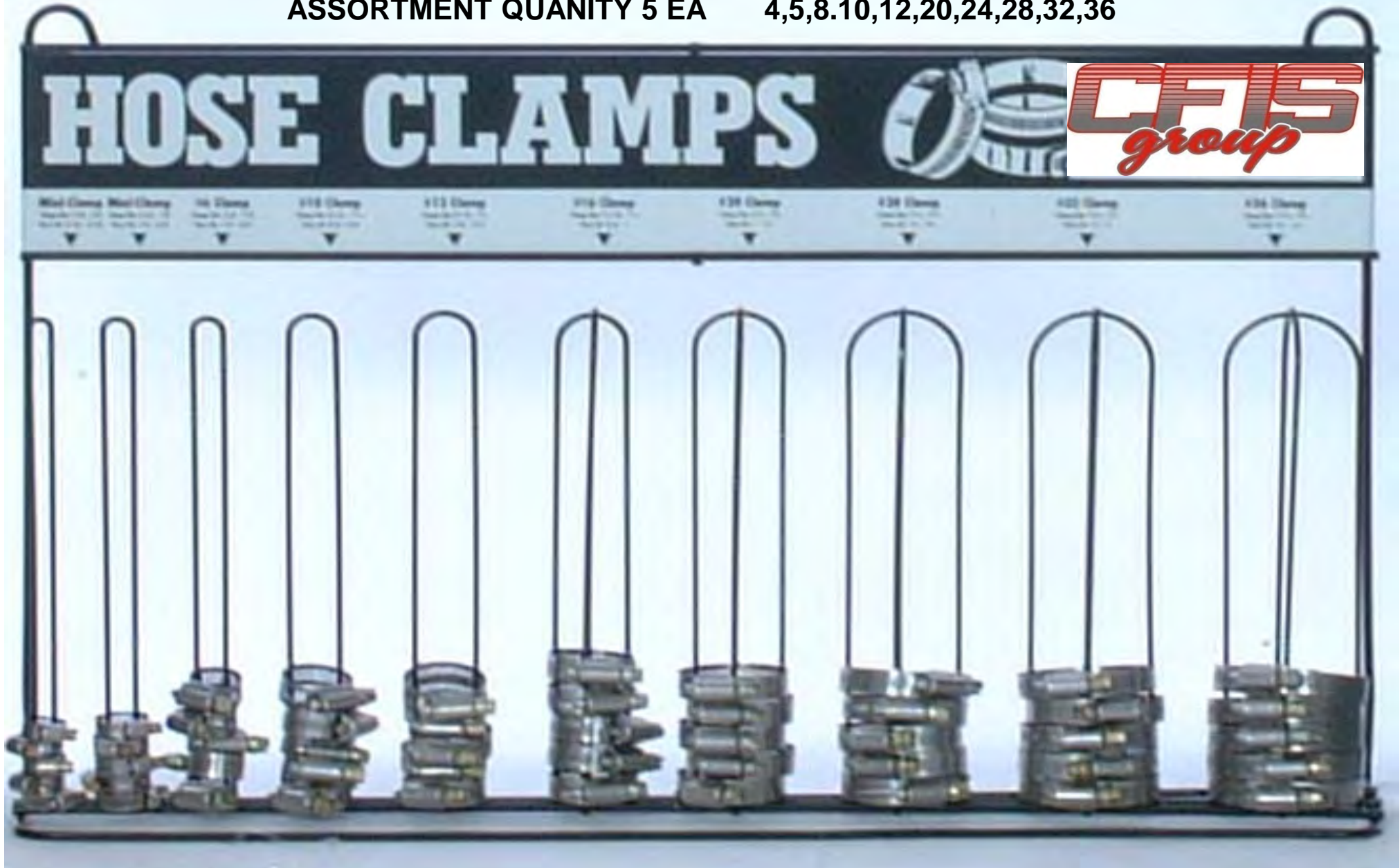

PART # 0395-55























**ASSORTMENT: LINER CLAMPS**

01/22

PART # 0396-25

**ASSORTMENT: GREASE FITTINGS**

































01/22

<p><b>396-585</b> 10</p>  <p><b>10 MM 90*</b></p>	<p><b>396-575</b> 10</p>  <p><b>10 MM ST</b></p>	<p><b>396-550</b> 10</p>  <p><b>8 MM ST</b></p>	<p><b>396-470</b> 10</p>  <p><b>5/16 ST DRIVE</b></p>	<p><b>396-560</b> 10</p>  <p><b>8 MM 90</b></p>	<p><b>396-370</b> 10</p>  <p><b>1/8P 90</b></p>
<p><b>396-337</b> 10</p>  <p><b>1/4-28 EXT LONG</b></p>	<p><b>396-555</b> 10</p>  <p><b>8 MM 45*</b></p>	<p><b>396-530</b> 10</p>  <p><b>6 MM 90*</b></p>		<p><b>396-580</b> 10</p>  <p><b>10 MM 45</b></p>	<p><b>396-365</b> 10</p>  <p><b>1/8P 45</b></p>
<p><b>396-335</b> 25</p>  <p><b>1/4-28 MED</b></p>	<p><b>396-340</b> 25</p>  <p><b>1/4-28 45*</b></p>	<p><b>396-525</b> 10</p>  <p><b>6 MM 45*</b></p>	<p><b>396-430</b> 10</p>  <p><b>1/4 ST DRIVE</b></p>	<p><b>396-390</b> 10</p>  <p><b>1/4 PIPE ST</b></p>	<p><b>396-360</b> 10</p>  <p><b>1/8P STRAIGHT LONG</b></p>
<p><b>396-330</b> 25</p>  <p><b>1/4-28 ST</b></p>	<p><b>396-345</b> 25</p>  <p><b>1/4-28 90*</b></p>	<p><b>396-520</b> 10</p>  <p><b>6 MM ST</b></p>	<p><b>396-415</b> 10</p>  <p><b>3/16 ST DRIVE</b></p>	<p><b>396-385</b> 10</p>  <p><b>1/4 PIPE ST</b></p>	<p><b>396-355</b> 25</p>  <p><b>1/8P ST</b></p>

PART # 0396-35

**ASSORTMENT: GREASE FITTINGS**

01/22

<p>396-568 5</p>  <p>8 MM X 1.25</p>	<p>396-575 5</p>  <p>10 MM X 1.00</p>	<p>396-580 5</p>  <p>10 MM X 1.00</p>	<p>396-585 5</p>  <p>10 MM X 1.00</p>	<p>396-586 5</p>  <p>10 MM X 1.50</p>	<p>396-590 5</p>  <p>6 MM DRIVE</p>	<p>396-592 5</p>  <p>8 MM DRIVE</p>	<p>396-594 0</p>  <p>Optional not in assortment 10 MM DRIVE</p>
<p>396-520 10</p>  <p>6 MM X 1.00</p>	<p>396-525 10</p>  <p>6 MM X 1.00</p>	<p>396-530 10</p>  <p>6 MM X 1.00</p>	<p>396-550 10</p>  <p>8 MM X 1.00</p>	<p>396-555 10</p>  <p>8 MM X 1.00</p>	<p>396-560 10</p>  <p>8 MM X 1.00</p>	<p>396-564 10</p>  <p>8 MM X 1.25</p>	<p>396-566 10</p>  <p>8 MM X 1.25</p>
<p>396-360 5</p>  <p>1/8P STRAIGHT Long</p>	<p>396-365 10</p>  <p>1/8 PIPE 45*</p>	<p>396-370 10</p>  <p>1/8 PIPE 90*</p>	<p>396-385 5</p>  <p>1/4 PIPE ST</p>	<p>396-390 5</p>  <p>1/4 PIPE 45*</p>	<p>396-415 10</p>  <p>3/16 ST DRIVE</p>	<p>396-430 10</p>  <p>1/4 ST DRIVE</p>	<p>396-470 10</p>  <p>5/16 ST DRIVE</p>
<p>396-325 10</p>  <p>Self Threading 1/4-28 ST</p>	<p>396-330 10</p>  <p>1/4-28 ST</p>	<p>396-335 10</p>  <p>1/4-28 MED</p>	<p>396-337 10</p>  <p>1/4-28 LONG</p>	<p>396-340 10</p>  <p>1/4-28 45*</p>	<p>396-345 10</p>  <p>1/4-28 90*</p>	<p>396-350 10</p>  <p>Self Threading 1/8P ST</p>	<p>396-355 10</p>  <p>1/8P ST</p>



**CANTON FLEET - INDUSTRIAL SUPPLY**  
**COLUMBUS FLEET - INDUSTRIAL SUPPLY**

WWW.cfisgroup.com

(614) 332-7464

PART # 0431-25

# ASSORTMENT: 14 GA WIRE ASSORTMENT

01/22

ASSORTMENT QUANTITY 1 RL EA

Red, White, Yellow, Green, Blue, Black, Brown





**CANTON FLEET - INDUSTRIAL SUPPLY**  
**COLUMBUS FLEET - INDUSTRIAL SUPPLY**

WWW.cfisgroup.com

(614) 332-7464

PART # 0439-25

# ASSORTMENT: NYLON TIES

01/22

439-015

25



5/16 X 14" HEAVY DUTY

439-014

100



3/16 X 14-1/4" TIES

439-011

100



3/16 X 11" TIES

439-007

100



3/16 X 7" TIES

439-006

100



1/8 X 5-1/2" TIES

439-090

25



BLACK TIE MOUNTS

439-004

100



3/32 X 3-3/4" TIES



PART # 0439-50

# COLOR ASSORTMENT: NYLON TIES

01/22

439-180

100



3/16 X 7" TIES

FLUORSECENT GREEN

439-181

100



3/16 X 7" TIES

FLUORSECENT PINK

439-184

100



3/16 X 7" TIES

FLUORSECENT BLUE

439-183

100



3/16 X 7" TIES

FLUORSECENT ORANGE

439-195

100



3/16 X 7" TIES

RED

439-197

100



3/16 X 7" TIES

YELLOW

439-191

100



3/16 X 7" TIES

PURPLE

439-193

100



3/16 X 7" TIES

GRAY

439-187

100



3/16 X 7" TIES

ORANGE

439-190

100



3/16 X 7" TIES

BLUE

439-189

100



3/16 X 7" TIES

GREEN

439-185

100



3/16 X 7" TIES

BROWN



**CANTON FLEET - INDUSTRIAL SUPPLY**  
**COLUMBUS FLEET - INDUSTRIAL SUPPLY**

WWW.cfisgroup.com

(614) 332-7464

PART # 0439-75

## ASSORTMENT: NYLON TIES ASSORTMENT

01/22

**ASSORTMENT QUANTITY 1 pack**

**1 ea Cabinet**

**100 ea 4" Ties**

**100 ea 6" Ties**

**100 ea 7" Ties**

**100 ea 11" Ties**

**100 ea 14" Ties**

**50 ea 15" Ties H/D**



PART # 0443-25

**ASSORTMENT: WIRE ENDS**













01/22

<p>452-035 25</p> <p>16-14 FEM</p>	<p>452-034 25</p> <p>16-14 MALE</p>	<p>442-025 25</p> <p>16-14 FEM</p>	<p>442-024 25</p> <p>16-14 MALE</p>	<p>441-015 25</p> <p>22-18 10 HOOK</p>	<p>441-011 25</p> <p>22-18 10 FORK</p>	<p>441-003 50</p> <p>22-18 10 R</p>	<p>451-000 50</p> <p>22-18 BUTT</p>
<p>442-015 25</p> <p>16-14 10 H</p>	<p>442-011 50</p> <p>16-14 10 F</p>	<p>442-007 25</p> <p>16-14 3/8 R</p>	<p>442-006 25</p> <p>16-14 5/16 R</p>	<p>442-005 50</p> <p>16-14 1/4 R</p>	<p>442-003 50</p> <p>16-14 10 R</p>		<p>452-000 50</p> <p>16-14 BUTT</p>
<p>443-015 25</p> <p>12-10 10 H</p>	<p>443-011 25</p> <p>12-10 10 F</p>	<p>443-008 15</p> <p>12-10 1/2 R</p>	<p>443-007 20</p> <p>12-10 3/8 R</p>	<p>443-006 25</p> <p>12-10 5/16 R</p>	<p>443-005 25</p> <p>12-10 1/4 R</p>	<p>443-003 50</p> <p>12-10 10 R</p>	<p>453-000 50</p> <p>12-10 BUTT</p>
<p>453-035 25</p> <p>12-10 FEM</p>	<p>453-034 25</p> <p>12-10 MALE</p>	<p>443-025 25</p> <p>12-10 FEM</p>	<p>443-024 25</p> <p>12-10 MALE</p>				<p>440-085 25</p> <p>T - TAP</p>

PART # 00472-14

**ASSORTMENT: KRIMP & SEAL**

01/22

<p>473-008 10</p>  <p>12-10 1/2 RING</p>	<p>473-007 10</p>  <p>12-10 3/8 RING</p>	<p>473-006 10</p>  <p>12-10 5/16 RING</p>	<p>473-005 10</p>  <p>12-10 1/4 RING</p>	<p>473-003 10</p>  <p>12-10 10 RING</p>	<p>473-000 25</p>  <p>12-10 BUTT</p>
<p>472-035 10</p>  <p>16-14 FEMALE</p>	<p>472-034 10</p>  <p>16-14 MALE</p>	<p>472-025 10</p>  <p>16-14 FEMALE</p>	<p>472-024 10</p>  <p>16-14 MALE</p>	<p>473-013 10</p>  <p>12-10 10 FORK</p>	<p>472-000 25</p>  <p>16-14 BUTT</p>
<p>472-013 10</p>  <p>16-14 10 FORK</p>	<p>472-007 10</p>  <p>16-14 3/8 RING</p>	<p>472-006 10</p>  <p>16-14 5/16 RING</p>	<p>472-005 5</p>  <p>16-14 1/4 RING</p>	<p>472-003 10</p>  <p>16-14 10 RING</p>	<p>471-000 10</p>  <p>22-18 BUTT</p>
<p>471-035 10</p>  <p>22-18 FEMALE</p>	<p>471-034 10</p>  <p>22-18 MALE</p>	<p>471-013 10</p>  <p>22-18 10 FORK</p>	<p>471-005 10</p>  <p>22-18 1/4 RING</p>	<p>471-003 10</p>  <p>22-18 10 RING</p>	<p>470-098 15</p>  <p>24 GAUGE BUTT</p>



**CANTON FLEET - INDUSTRIAL SUPPLY**  
**COLUMBUS FLEET - INDUSTRIAL SUPPLY**



WWW.cfisgroup.com

(614) 332-7464

PART # 0472-18

**ASSORTMENT: KRIMP & SEAL**

01/22

<p>471-035 10</p>  <p>22-18 FEMALE</p>	<p>471-034 10</p>  <p>22-18 MALE</p>	<p>471-005 10</p>  <p>22-18 1/4 RING</p>	<p>471-003 10</p>  <p>22-18 10 RING</p>	<p>471-000 10</p>  <p>22-18 BUTT</p>	
<p>472-007 10</p>  <p>16-14 3/8 RING</p>	<p>472-006 10</p>  <p>16-14 5/16 RING</p>	<p>472-005 10</p>  <p>16-14 1/4 RING</p>	<p>472-003 10</p>  <p>16-14 10 RING</p>	<p>472-000 10</p>  <p>16-14 BUTT</p>	
<p>472-035 10</p>  <p>16-14 FEMALE</p>	<p>472-034 10</p>  <p>16-14 MALE</p>	<p>472-013 10</p>  <p>16-14 10 FORK</p>	<p>473-035 10</p>  <p>12-10 FEMALE</p>	<p>473-034 10</p>  <p>12-10 MALE</p>	
<p>473-008 10</p>  <p>12-10 1/2 RING</p>	<p>473-007 10</p>  <p>12-10 3/8 RING</p>	<p>473-005 10</p>  <p>12-10 1/4 RING</p>	<p>473-003 10</p>  <p>12-10 10 RING</p>	<p>473-000 10</p>  <p>12-10 BUTT</p>	

PART # 0472-23

**ASSORTMENT: KRIMP & SEAL**

01/22

<p>471-035 10</p>  <p>22-18 FEMALE</p>	<p>471-034 10</p>  <p>22-18 MALE</p>	<p>471-005 25</p>  <p>22-18 1/4 RING</p>	<p>471-003 25</p>  <p>22-18 10 RING</p>	<p>471-000 25</p>  <p>22-18 BUTT</p>	
<p>472-007 10</p>  <p>16-14 3/8 RING</p>	<p>472-006 25</p>  <p>16-14 5/16 RING</p>	<p>472-005 25</p>  <p>16-14 1/4 RING</p>	<p>472-003 25</p>  <p>16-14 10 RING</p>	<p>472-000 25</p>  <p>16-14 BUTT</p>	
<p>472-035 10</p>  <p>16-14 FEMALE</p>	<p>472-034 10</p>  <p>16-14 MALE</p>	<p>472-013 25</p>  <p>16-14 10 FORK</p>	<p>473-035 10</p>  <p>12-10 FEMALE</p>	<p>473-034 10</p>  <p>12-10 MALE</p>	
<p>473-008 10</p>  <p>12-10 1/2 RING</p>	<p>473-007 10</p>  <p>12-10 3/8 RING</p>	<p>473-005 25</p>  <p>12-10 1/4 RING</p>	<p>473-003 25</p>  <p>12-10 10 RING</p>	<p>473-000 25</p>  <p>12-10 BUTT</p>	

PART # 0472-24

**ASSORTMENT: KRIMP & SEAL**





















01/22

<p>472-034 10</p>  <p>16-14 MALE</p>	<p>471-035 10</p>  <p>22-18 FEMALE</p>	<p>471-034 10</p>  <p>22-18 MALE</p>	<p>471-005 25</p>  <p>22-18 1/4 RING</p>	<p>471-003 25</p>  <p>22-18 10 RING</p>	<p>471-000 25</p>  <p>22-18 BUTT</p>
<p>472-035 10</p>  <p>16-14 FEMALE</p>	<p>472-007 10</p>  <p>16-14 3/8 RING</p>	<p>472-006 25</p>  <p>16-14 5/16 RING</p>	<p>472-005 25</p>  <p>16-14 1/4 RING</p>	<p>472-003 25</p>  <p>16-14 10 RING</p>	<p>472-000 25</p>  <p>16-14 BUTT</p>
<p>472-013 25</p>  <p>16-14 10 FORK</p>	<p>470-090 10</p>  <p>22-18 / 16-14</p>	<p>470-091 10</p>  <p>16-14 / 12-10</p>	<p>470-092 5</p>  <p>12-10 / 8 Ga</p>	<p>473-035 10</p>  <p>12-10 FEMALE</p>	<p>473-034 10</p>  <p>12-10 MALE</p>
<p>473-008 10</p>  <p>12-10 1/2 RING</p>	<p>473-007 10</p>  <p>12-10 3/8 RING</p>	<p>473-006 10</p>  <p>12-10 5/16 RING</p>	<p>473-005 25</p>  <p>12-10 1/4 RING</p>	<p>473-003 25</p>  <p>12-10 10 RING</p>	<p>473-000 25</p>  <p>12-10 BUTT</p>

PART # 0472-25

**ASSORTMENT: KRIMP & SEAL**

01/22

<p>471-035 10</p>  <p>22-18 FEMALE</p>	<p>471-034 10</p>  <p>22-18 MALE</p>	<p>471-005 25</p>  <p>22-18 1/4 RING</p>	<p>471-003 25</p>  <p>22-18 10 RING</p>	<p>471-000 25</p>  <p>22-18 BUTT</p>
<p>472-007 10</p>  <p>16-14 3/8 RING</p>	<p>472-006 25</p>  <p>16-14 5/16 RING</p>	<p>472-005 25</p>  <p>16-14 1/4 RING</p>	<p>472-003 25</p>  <p>16-14 10 RING</p>	<p>472-000 25</p>  <p>16-14 BUTT</p>
<p>472-035 10</p>  <p>16-14 FEMALE</p>	<p>472-034 10</p>  <p>16-14 MALE</p>	<p>472-013 25</p>  <p>16-14 10 FORK</p>	<p>473-035 10</p>  <p>12-10 FEMALE</p>	<p>473-034 10</p>  <p>12-10 MALE</p>
<p>473-008 10</p>  <p>12-10 1/2 RING</p>	<p>473-007 10</p>  <p>12-10 3/8 RING</p>	<p>473-005 25</p>  <p>12-10 1/4 RING</p>	<p>473-003 25</p>  <p>12-10 10 RING</p>	<p>473-000 25</p>  <p>12-10 BUTT</p>

412-006 1

**TURBO-LITE**  
**TORCH**



413-125 1

**WIRE END**  
**CRIMPER**



PART # 0472-27

**ASSORTMENT: KRIMP & SEAL**

01/22

<p>472-034 10</p>  <p>16-14 MALE</p>	<p>471-035 10</p>  <p>22-18 FEMALE</p>	<p>471-034 10</p>  <p>22-18 MALE</p>	<p>471-005 25</p>  <p>22-18 1/4 RING</p>	<p>471-003 25</p>  <p>22-18 10 RING</p>	<p>471-000 25</p>  <p>22-18 BUTT</p>
<p>472-035 10</p>  <p>16-14 FEMALE</p>	<p>472-007 10</p>  <p>16-14 3/8 RING</p>	<p>472-006 25</p>  <p>16-14 5/16 RING</p>	<p>472-005 25</p>  <p>16-14 1/4 RING</p>	<p>472-003 25</p>  <p>16-14 10 RING</p>	<p>472-000 25</p>  <p>16-14 BUTT</p>
<p>472-051 25</p>  <p>.180 Female</p>	<p>472-013 10</p>  <p>16-14 10 FORK</p>	<p>470-090 10</p>  <p>22-18 / 16-14</p>	<p>470-091 10</p>  <p>16-14 / 12-10</p>	<p>473-035 10</p>  <p>12-10 FEMALE</p>	<p>473-034 10</p>  <p>12-10 MALE</p>
<p>472-052 10</p>  <p>.180 Male</p>	<p>473-008 10</p>  <p>12-10 1/2 RING</p>	<p>473-007 10</p>  <p>12-10 3/8 RING</p>	<p>473-005 25</p>  <p>12-10 1/4 RING</p>	<p>473-003 25</p>  <p>12-10 10 RING</p>	<p>473-000 25</p>  <p>12-10 BUTT</p>



**CANTON FLEET - INDUSTRIAL SUPPLY**  
**COLUMBUS FLEET - INDUSTRIAL SUPPLY**







WWW.cfisgroup.com

(614) 332-7464

PART # 0472-45

# ASSORTMENT: KRIMP & SEAL

01/22

				<p>470-030 10</p>  <p>22-18 to 24 ga</p>	<p>470-032 10</p>  <p>18-10 to 8-10 ga</p>
					<p>470-024 10</p>  <p>8 to 12-10 ga</p>
					<p>470-022 10</p>  <p>12-10 to 16-14 ga</p>
				<p>470-018 10</p>  <p>20-18 to 24-22 ga</p>	<p>470-020 10</p>  <p>16-14 to 20-18 ga</p>

PART # 0476-25

**ASSORTMENT: WEATHER PACK**

01/22

<p>476-169 25</p>  <p>10-12 SOCKET</p>		<p>476-070 4</p>  <p>1 FEMALE</p>	<p>476-072 4</p>  <p>2 FEMALE</p>	<p>476-074 4</p>  <p>3 FEMALE</p>	<p>476-078 2</p>  <p>6 FEMALE</p>
<p>476-168 25</p>  <p>10-12 PIN</p>		<p>476-050 4</p>  <p>1 MALE</p>	<p>476-052 4</p>  <p>2 MALE</p>	<p>476-054 4</p>  <p>3 MALE</p>	<p>476-058 2</p>  <p>6 MALE</p>
<p>476-155 25</p>  <p>22-18 SOCKET</p>	<p>476-161 25</p>  <p>16-14 SOCKET</p>		<p>476-128 25</p>  <p>16-14 SEAL</p>	<p>476-130 25</p>  <p>12-10 SEAL</p>	<p>476-076 3</p>  <p>4 FEMALE</p>
<p>476-154 25</p>  <p>22-18 PIN</p>	<p>476-160 25</p>  <p>16-14 PIN</p>	<p>476-124 25</p>  <p>24-18 SEAL</p>	<p>476-126 25</p>  <p>20-18 SEAL</p>	<p>476-122 10</p>  <p>PLUG</p>	<p>476-056 3</p>  <p>4 MALE</p>

PART # 0476-50

**METRI-PACK 280 SEALED CONNECTORS**























01/22

<p>476-850 2</p>  <p>1-way male</p>	<p>476-852 2</p>  <p>2-way male</p>	<p>476-854 2</p>  <p>3-way male</p>	<p>476-856 2</p>  <p>4-way male</p>	<p>476-858 2</p>  <p>5-way male</p>	<p>476-962 2</p>  <p>4-way male</p>
<p>476-870 2</p>  <p>1-way female</p>	<p>476-872 2</p>  <p>2-way female</p>	<p>476-874 2</p>  <p>3-way female</p>	<p>476-876 2</p>  <p>4-way female</p>	<p>476-878 2</p>  <p>5-way female</p>	<p>476-966 2</p>  <p>5-way male</p>
<p>476-952 4</p>  <p>1-way term holder</p>	<p>476-954 4</p>  <p>2-way term holder</p>	<p>476-956 2</p>  <p>3-way male term holder</p>	<p>476-960 2</p>  <p>4-way fem term holder</p>	<p>476-964 2</p>  <p>2-way fem term holder</p>	
<p>476-920 12</p>  <p>14-12 guage</p>	<p>476-922 12</p>  <p>14 - 12 guage</p>	<p>476-958 2</p>  <p>3-way fem term holder</p>	<p>476-128 2 5</p>  <p>Gray sealer</p>	<p>476-130 25</p>  <p>Blue sealer</p>	

PART # 0477-28

**ASSORTMENT: DEUTSCH DT (AT)**





























01/22

<p>477-172 2</p>  <p>Receptacle 2-PIN</p>	<p>477-174 2</p>  <p>Receptacle 3-PIN</p>	<p>477-176 2</p>  <p>Receptacle 4-PIN</p>	<p>477-178 2</p>  <p>Receptacle 6-PIN</p>	<p>477-180 2</p>  <p>Receptacle 8-PIN</p>	<p>477-181 2</p>  <p>Receptacle 12-PIN</p>
<p>477-160 2</p>  <p>Plug 2-PIN</p>	<p>477-162 2</p>  <p>Plug 3-PIN</p>	<p>477-164 2</p>  <p>Plug 4-PIN</p>	<p>477-166 2</p>  <p>Plug 6-PIN</p>	<p>477-168 2</p>  <p>Plug 8-PIN</p>	
<p>477-182 2</p>  <p>477-202</p>	<p>477-184 2</p>  <p>477-204</p>	<p>477-186 2</p>  <p>477-206</p>	<p>477-188 2</p>  <p>477-208</p>	<p>477-190 2</p>  <p>477-210</p>	<p>477-170 2</p>  <p>477-170</p>
<p>477-212 2</p>  <p>477-212</p> <p>12-PIN</p>	<p>477-192 2</p>  <p>477-192</p> <p>12-PIN</p>	<p>2 477-322 25</p>  <p>477-322</p> <p>14-16-PIN</p>	<p>477-324 25</p>  <p>477-324</p> <p>14-16-Socket</p>	<p>477-230 10</p>  <p>477-230</p> <p>Universal Cavity Plug</p>	

PART # 0477-30

**ASSORTMENT: DEUTSCH DT (AT)**

01/22

<p>477-182 2</p>  <p>2-PIN</p>	<p>477-184 2</p>  <p>3-PIN</p>	<p>477-186 2</p>  <p>4-PIN</p>	<p>477-188 2</p>  <p>6-PIN</p>	<p>477-190 2</p>  <p>8-PIN</p>	<p>477-192 2</p>  <p>12-PIN</p>		<p>477-230 10</p>  <p>Universal Cavity Plug</p>
<p>477-202 2</p>  <p>2-PIN</p>	<p>477-204 2</p>  <p>3-PIN</p>	<p>477-206 2</p>  <p>4-PIN</p>	<p>477-208 2</p>  <p>6-PIN</p>	<p>477-210 2</p>  <p>8-PIN</p>	<p>477-212 2</p>  <p>12-PIN</p>		
<p>477-172 2</p>  <p>Receptacle 2-PIN</p>	<p>477-174 2</p>  <p>Receptacle 3-PIN</p>	<p>477-176 2</p>  <p>Receptacle 4-PIN</p>	<p>477-178 2</p>  <p>Receptacle 6-PIN</p>	<p>477-180 2</p>  <p>Receptacle 8-PIN</p>	<p>477-181 2</p>  <p>Receptacle 12-PIN</p>	<p>477-328 10</p>  <p>16-18-PIN</p>	<p>477-330 10</p>  <p>16-18-Socket</p>
<p>477-160 2</p>  <p>Plug 2-PIN</p>	<p>477-162 2</p>  <p>Plug 3-PIN</p>	<p>477-164 2</p>  <p>Plug 4-PIN</p>	<p>477-166 2</p>  <p>Plug 6-PIN</p>	<p>477-168 2</p>  <p>Plug 8-PIN</p>	<p>477-170 2</p>  <p>Plug 12-PIN</p>	<p>477-322 10</p>  <p>14-16-PIN</p>	<p>477-324 10</p>  <p>14-16-Socket</p>



**PART # 0479-25**

**ASSORTMENT: HEAT SHRINK**

01/22

**479-302**

**2**

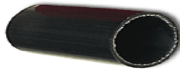

**1' x 6 BLACK H/D**

**479-316**

**2**



**1" x 6 RED H/D**

**479-310**

**2**

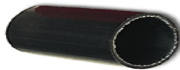

**3/4 x 6 BLACK H/D**

**479-312**

**2**



**3/4 x 6 RED H/D**

**479-208**

**4**

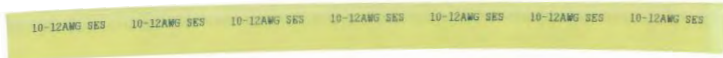

**YELLOW x 6 SEMI-RIGID**

**479-302**

**2**



**1/2 HEAVY DUTY**

**479-204**

**4**



**RED x 6 SEMI-RIGID**

**479-206**

**4**



**BLUE x 6 SEMI-RIGID**

**479-108**

**4**



**3/8 x 6 MEDIUM WALL**

**479-110**

**4**



**1/2 x 6 MEDIUM WALL**

**479-104**

**4**



**3/16 x 6 MEDIUM WALL**

**479-106**

**4**



**1/4 x 6 MEDIUM WALL**



**PART # 0479-35**

# ASSORTMENT: HEAT SHRINK

01/22

**479-302**                      **2**



**.40 HEAVY DUTY**

**479-304**                      **2**



**.40 x 6 RED H/D**

**479-300**                      **2**



**.30 HEAVY DUTY**

**479-301**                      **2**



**.30 x 6 RED H/D**

**479-206**                      **4**



**BLUE x 6 SEMI-RIGID**

**479-208**                      **4**



**YELLOW x 6 SEMI-RIGID**

**479-110**                      **4**



**1/2 x 6 MEDIUM WALL**

**479-204**                      **4**



**RED x 6 SEMI-RIGID**

**479-106**                      **4**



**1/4 x 6 MEDIUM WALL**

**479-108**                      **4**



**3/8 x 6 MEDIUM WALL**

**479-102**                      **4**



**1/8 x 6 MEDIUM WALL**

**479-104**                      **4**



**3/16 x 6 MEDIUM WALL**



**CANTON FLEET - INDUSTRIAL SUPPLY**  
**COLUMBUS FLEET - INDUSTRIAL SUPPLY**

WWW.cfisgroup.com

(614) 332-7464

PART # 0479-40

# ASSORTMENT: HEAT SHRINK

01/22

479-310

2

.80 HEAVY DUTY



479-312

2

.80 HEAVY DUTY



479-314

2

1.10 HEAVY DUTY



479-316

2

1.10 HEAVY DUTY



**PART # 0491-35**

**ASSORTMENT: BATTERY ENDS**





01/22

<p><b>491-120</b> 2</p>  <p><b>4 GA UNIVERSAL</b></p>	<p><b>491-135</b> 2</p>  <p><b>1/0 POSITIVE</b></p>	<p><b>491-136</b> 2</p>  <p><b>1/0 NEGATIVE</b></p>	<p><b>491-141</b> 2</p>  <p><b>2/0 POSITIVE</b></p>	<p><b>491-142</b> 2</p>  <p><b>2/0 NEGATIVE</b></p>	
<p><b>491-125</b> 2</p>  <p><b>1-2 GA UNIVERSAL</b></p>		<p><b>4</b></p>	<p><b>491-145</b> 2</p>  <p><b>3/0 POSITIVE</b></p>	<p><b>491-146</b> 2</p>  <p><b>3/0 NEGATIVE</b></p>	
<p><b>491-234</b> 4</p>  <p><b>2/0 3/8 RING</b></p>	<p><b>491-236</b> 4</p>  <p><b>2/0 1/2 RING</b></p>	<p><b>491-238</b> 4</p>  <p><b>3/0 3/8 RING</b></p>	<p><b>491-240</b> 4</p>  <p><b>3/0 1/2 RING</b></p>		
		<p><b>491-228</b> 4</p>  <p><b>1-2 GA 3/8 RING</b></p>	<p><b>491-230</b> 4</p>  <p><b>1/0 3/8 RING</b></p>	<p><b>491-232</b> 4</p>  <p><b>1/0 1/2 RING</b></p>	

PART # 0491-45

**ASSORTMENT: BATTERY ENDS**





















01/22

<p>490-170 2</p>  <p>2/0 SOLDER</p>	<p>491-135 2</p>  <p>1/0 POSITIVE</p>	<p>491-136 2</p>  <p>1/0 NEGATIVE</p>	<p>491-141 2</p>  <p>2/0 POSITIVE</p>	<p>491-142 2</p>  <p>2/0 NEGATIVE</p>	
<p>490-160 2</p>  <p>1/0 SOLDER</p>	<p>491-110 2</p>  <p>4 GA SPLICER</p>	<p>491-116 2</p>  <p>2/0 SPLICER</p>	<p>491-125 2</p>  <p>1-2 GA UNIVERSAL</p>	<p>491-120 2</p>  <p>4 GA UNIVERSAL</p>	
<p>490-130 2</p>  <p>1 GA SOLDER</p>	<p>491-166 2</p>  <p>2/0 POSITIVE</p>	<p>491-168 2</p>  <p>2/0 NEGATIVE</p>	<p>491-234 4</p>  <p>2/0 3/8 RING</p>	<p>491-236 4</p>  <p>2/0 1/2 RING</p>	
<p>490-120 2</p>  <p>4 GA SOLDER</p>		<p>491-228 4</p>  <p>1-2 GA 3/8 RING</p>	<p>491-230 4</p>  <p>1/0 3/8 RING</p>	<p>491-232 4</p>  <p>1/0 1/2 RING</p>	

**PART # 0492-25**

**ASSORTMENT: COPPER LUGS**

01/22

<p><b>492-588</b> 5</p>  <p><b>1/0 1/2 RING</b></p>	<p><b>492-594</b> 5</p>  <p><b>2/0 5/16 RING</b></p>	<p><b>492-596</b> 5</p>  <p><b>2/0 3/8 RING</b></p>	<p><b>492-598</b> 5</p>  <p><b>2/0 1/2 RING</b></p>	<p><b>492-606</b> 5</p>  <p><b>3/0 3/8 RING</b></p>	<p><b>492-608</b> 5</p>  <p><b>3/0 1/2 RING</b></p>
<p><b>492-564</b> 5</p>  <p><b>2 GA 5/16 RING</b></p>	<p><b>492-566</b> 5</p>  <p><b>2 GA 3/8 RING</b></p>	<p><b>492-568</b> 5</p>  <p><b>2 GA 1/2 RING</b></p>	<p><b>492-584</b> 5</p>  <p><b>1/0 5/16 RING</b></p>	<p><b>492-586</b> 5</p>  <p><b>1/0 3/8 RING</b></p>	
<p><b>492-552</b> 5</p>  <p><b>6/4 GA 1/4 RING</b></p>	<p><b>492-554</b> 5</p>  <p><b>6/4 GA 5/16 RING</b></p>	<p><b>492-556</b> 5</p>  <p><b>6/4 GA 3/8 RING</b></p>	<p><b>492-558</b> 5</p>  <p><b>6/4 GA 1/2 RING</b></p>	<p><b>492-562</b> 5</p>  <p><b>2 GA 1/4 RING</b></p>	
<p><b>492-530</b> 5</p>  <p><b>8 GA #10 RING</b></p>	<p><b>492-532</b> 5</p>  <p><b>8 GA 1/4 RING</b></p>	<p><b>492-534</b> 5</p>  <p><b>8 GA 5/16 RING</b></p>	<p><b>492-536</b> 5</p>  <p><b>8 GA 3/8 RING</b></p>	<p><b>492-538</b> 5</p>  <p><b>8 GA 1/2 RING</b></p>	

**PART # 0499-25**

**ASSORTMENT: TUBE CLAMPS**

01/22

**499-008 25**



**1/2 NYLON CLAMP**

**499-258 10**



**1/2 H/D CLAMP**

**499-266 10**



**1" H/D CLAMP**

**499-282 5**



**2 H/D CLAMP**

**499-006 25**



**3/8 NYLON CLAMP**

**499-256 20**



**3/8 H/D CLAMP**

**499-262 10**



**3/4 H/D CLAMP**

**499-274 5**



**1-1/2 H/D CLAMP**

**499-005 25**



**5/16 NYLON CLAMP**

**499-255 20**



**5/16 H/D CLAMP**

**499-260 10**



**5/8 H/D CLAMP**

**499-270 5**



**1-1/4 H/D CLAMP**

**499-004 25**



**1/4 NYLON CLAMP**

**499-254 20**



**1/4 H/D CLAMP**

PART # 0499-27

# ASSORTMENT: TUBE CLAMPS

01/22

499-258

10



1/2 H/D CLAMP

499-256

10



3/8 H/D CLAMP

499-255

15



5/16 H/D CLAMP

499-254

15



1/4 H/D CLAMP

499-262

10



3/4 H/D CLAMP

499-260

10



5/8 H/D CLAMP

499-270

10



1-1/4 H/D CLAMP

499-266

10



1" H/D CLAMP

499-282

5



2 H/D CLAMP

499-274

5



1-1/2 H/D CLAMP

**PART # 0499-30**

**ASSORTMENT: TUBE CLAMPS**

01/22

**499-008**

**25**



**1/2 NYLON CLAMP**

**499-410**

**10**



**5/8T X 3/8H PADDED CLAMP**

**499-414**

**5**



**1" T X 3/8H PADDED CLAMP**

**499-420**

**5**



**1-3/8T X 3/8H PADDED CLAMP**

**499-006**

**25**



**3/8 NYLON CLAMP**

**499-408**

**10**



**1/2T X 3/8H PADDED CLAMP**

**499-005**

**25**



**5/16 NYLON CLAMP**

**499-406**

**10**



**3/8T X 3/8H PADDED CLAMP**

**499-412**

**5**



**3/4T X 3/8H PADDED CLAMP**

**499-418**

**5**

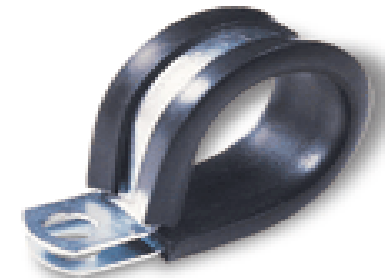

**1-1/4T X 3/8H PADDED CLAMP**

**499-004**

**25**



**1/4 NYLON CLAMP**

**499-404**

**10**



**1/4T X 3/8H PADDED CLAMP**



**PART # 0499-35**

# ASSORTMENT: TUBE CLAMPS

01/22

**499-410**      10



**5/8T X 3/8H PADDED CLAMP**

**499-408**      10



**1/2T X 3/8H PADDED CLAMP**

**499-406**      10



**3/8T X 3/8H PADDED CLAMP**

**499-404**      10



**1/4T X 3/8H PADDED CLAMP**

**499-414**      5



**1" T X 3/8H PADDED CLAMP**

**499-412**      5



**3/4T X 3/8H PADDED CLAMP**

**499-420**      5



**1-3/8T X 3/8H PADDED CLAMP**

**499-418**      5



**1-1/4T X 3/8H PADDED CLAMP**

**499-430**      5



**2" T X 3/8H PADDED CLAMP**

**499-421**      5

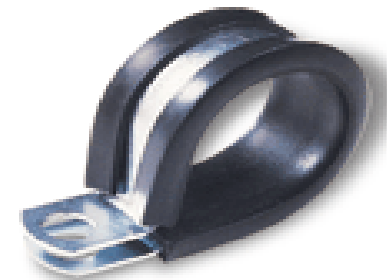

**1-1/2T X 3/8H PADDED CLAMP**



**PART # 0499-45**

# ASSORTMENT: TUBE CLAMPS

01/22

**499-310**      10



**5/8T X 1/4H PADDED CLAMP**

**499-308**      10



**1/2T X 1/4H PADDED CLAMP**

**499-306**      10



**3/8T X 1/4H PADDED CLAMP**

**499-304**      10



**1/4T X 1/4H PADDED CLAMP**

**499-314**      10



**7/8T X 1/4H PADDED CLAMP**

**499-312**      10



**3/4T X 1/4H PADDED CLAMP**

**499-318**      5



**1-1/4T X 1/4H PADDED CLAMP**

**499-316**      5



**1" T X 1/4H PADDED CLAMP**

**499-324**      5



**2" T X 1/4H PADDED CLAMP**

**499-320**      5



**1-1/2T X 1/4H PADDED CLAMP**

PART # 0511-25

# ASSORTMENT: AUTOMOTIVE BULB

01/22

511-085 10



561

511-080 10



97

511-160 10



2057

511-165 10



2057 NA

511-037 10



194 NA

511-052 10



1893/1889/1891

511-150 10



1157

511-200 10



3157 N/A

511-035 10



194

511-040 10

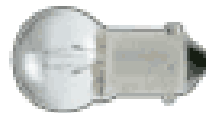

53

511-145 10



1156

511-190 10



3157

511-025 10



37

511-045 10



57

511-120 10



1003

511-185 10



3156

PART # 0511-35

**ASSORTMENT: AUTOMOTIVE BULB**

01/22

511-060 10



211-2

511-052 10



1893

511-040 10



53

511-037 10



194 NA

511-035 10



194

511-025 10



37

511-095 10



904/906

511-075 10



89

511-070 10



67

511-200 10



3157 N/A

511-186 10



3156 N/A

511-153 10



1157 N/A

511-146 10



1156 N/A

511-190 10



3157

511-185 10



3156

511-150 10



1157

511-145 10

















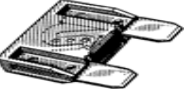

1156

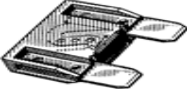

**PART # 0512-10**

# ASSORTMENT: FUSES



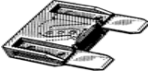



















01/22

							<p><b>512-340</b></p> <p>10</p>  <p>Orange AT0-40</p>
<p><b>512-304</b></p> <p>10</p>  <p>Pink AT0-4</p>	<p><b>512-305</b></p> <p>10</p>  <p>Tan AT0-5</p>	<p><b>512-307</b></p> <p>10</p>  <p>Brown AT0-7-1/2</p>	<p><b>512-310</b></p> <p>10</p>  <p>Red AT0-10</p>	<p><b>512-315</b></p> <p>10</p>  <p>Blue AT0-15</p>	<p><b>512-320</b></p> <p>10</p>  <p>Yellow AT0-20</p>	<p><b>512-325</b></p> <p>10</p>  <p>Clear AT0-25</p>	<p><b>512-330</b></p> <p>10</p>  <p>Green AT0-30</p>
<p><b>512-404</b></p> <p>10</p>  <p>Pink MINI-ATC-4</p>	<p><b>512-405</b></p> <p>10</p>  <p>Tan MINI-ATC-5</p>	<p><b>512-407</b></p> <p>10</p>  <p>Brown MINI-ATC-7-1/2</p>	<p><b>512-410</b></p> <p>10</p>  <p>Red MINI-ATC-10</p>	<p><b>512-415</b></p> <p>10</p>  <p>Blue MINI-ATC-15</p>	<p><b>512-420</b></p> <p>10</p>  <p>Yellow MINI-ATC-20</p>	<p><b>512-425</b></p> <p>10</p>  <p>Clear MINI-ATC-25</p>	<p><b>512-430</b></p> <p>10</p>  <p>Green MINI-ATC-30</p>

PART # 0512-25

**ASSORTMENT: FUSES**





01/22

<p>512-520 1</p>  <p>MAXI-20</p>	<p>512-530 1</p>  <p>MAXI-30</p>	<p>512-540 1</p>  <p>MAXI-40</p>	<p>512-542 1</p>  <p>MAXI-50</p>	<p>512-544 1</p>  <p>MAXI-60</p>	<p>512-546 1</p>  <p>MAXI-70</p>	<p>512-548 1</p>  <p>MAXI-80</p>	
	<p>512-230 10</p>  <p>AGC-10</p>	<p>512-235 10</p>  <p>AGC-15</p>	<p>512-240 10</p>  <p>AGC-20</p>	<p>512-245 10</p>  <p>AGC-25</p>	<p>512-250 10</p>  <p>AGC-30</p>	<p>512-330 10</p>  <p>AT0-30</p>	<p>512-340 10</p>  <p>AT0-40</p>
<p>512-303 10</p>  <p>AT0-3</p>	<p>512-304 10</p>  <p>AT0-4</p>	<p>512-305 10</p>  <p>AT0-5</p>	<p>512-307 10</p>  <p>AT0-7-1/2</p>	<p>512-310 10</p>  <p>AT0-10</p>	<p>512-315 10</p>  <p>AT0-15</p>	<p>512-320 10</p>  <p>AT0-20</p>	<p>512-325 10</p>  <p>AT0-25</p>
<p>512-404 10</p>  <p>MINI-ATC-4</p>	<p>512-405 10</p>  <p>MINI-ATC-5</p>	<p>512-407 10</p>  <p>MINI-ATC-7-1/2</p>	<p>512-410 10</p>  <p>MINI-ATC-10</p>	<p>512-415 10</p>  <p>MINI-ATC-15</p>	<p>512-420 10</p>  <p>MINI-ATC-20</p>	<p>512-425 10</p>  <p>MINI-ATC-25</p>	<p>512-430 10</p>  <p>MINI-ATC-30</p>

**PART # 0512-30**

**ASSORTMENT: FUSES**

01/22

<p><b>512-360</b> 1</p>  <p><b>5 AMP</b> <b>MICRO-2</b></p>	<p><b>512-520</b> 1</p>  <p><b>MAXI-20</b></p>	<p><b>512-530</b> 1</p>  <p><b>MAXI-30</b></p>	<p><b>512-540</b> 1</p>  <p><b>MAXI-40</b></p>	<p><b>512-542</b> 1</p>  <p><b>MAXI-50</b></p>	<p><b>512-544</b> 1</p>  <p><b>MAXI-60</b></p>	<p><b>512-546</b> 1</p>  <p><b>MAXI-70</b></p>	<p><b>512-548</b> 1</p>  <p><b>MAXI-80</b></p>
<p><b>512-362</b> 5</p>  <p><b>7.5 AMP</b> <b>MICRO-2</b></p>	<p><b>512-364</b> 5</p>  <p><b>10 AMP</b> <b>MICRO-2</b></p>	<p><b>512-366</b> 5</p>  <p><b>15 AMP</b> <b>MICRO-2</b></p>	<p><b>512-368</b> 5</p>  <p><b>20 AMP</b> <b>MICRO-2</b></p>	<p><b>512-370</b> 5</p>  <p><b>25 AMP</b> <b>MICRO-2</b></p>	<p><b>512-372</b> 5</p>  <p><b>30 AMP</b> <b>MICRO-2</b></p>	<p><b>512-330</b> 10</p>  <p><b>AT0-30</b></p>	<p><b>512-340</b> 10</p>  <p><b>AT0-40</b></p>
<p><b>512-303</b> 10</p>  <p><b>AT0-3</b></p>	<p><b>512-304</b> 10</p>  <p><b>AT0-4</b></p>	<p><b>512-305</b> 10</p>  <p><b>AT0-5</b></p>	<p><b>512-307</b> 10</p>  <p><b>AT0-7-1/2</b></p>	<p><b>512-310</b> 10</p>  <p><b>AT0-10</b></p>	<p><b>512-315</b> 10</p>  <p><b>AT0-15</b></p>	<p><b>512-320</b> 10</p>  <p><b>AT0-20</b></p>	<p><b>512-325</b> 10</p>  <p><b>AT0-25</b></p>
<p><b>512-404</b> 10</p>  <p><b>MINI-ATC-4</b></p>	<p><b>512-405</b> 10</p>  <p><b>MINI-ATC-5</b></p>	<p><b>512-407</b> 10</p>  <p><b>MINI-ATC-7-1/2</b></p>	<p><b>512-410</b> 10</p>  <p><b>MINI-ATC-10</b></p>	<p><b>512-415</b> 10</p>  <p><b>MINI-ATC-15</b></p>	<p><b>512-420</b> 10</p>  <p><b>MINI-ATC-20</b></p>	<p><b>512-425</b> 10</p>  <p><b>MINI-ATC-25</b></p>	<p><b>512-430</b> 10</p>  <p><b>MINI-ATC-30</b></p>

**PART # 0512-33**

**ASSORTMENT: FUSES**

01/22

<p>512-302 10</p>  <p>AT0-2</p>	<p>512-305 10</p>  <p>AT0-5</p>	<p>512-307 10</p>  <p>AT0-7-1/2</p>	<p>512-310 10</p>  <p>AT0-10</p>	<p>512-315 10</p>  <p>AT0-15</p>	<p>512-320 10</p>  <p>AT0-20</p>	<p>512-325 10</p>  <p>AT0-25</p>	<p>512-330 10</p>  <p>AT0-30</p>
<p>512-335 10</p>  <p>AT0-35</p>	<p>512-340 10</p>  <p>AT0-40</p>	<p>512-402 10</p>  <p>MINI-ATC-2</p>	<p>512-405 10</p>  <p>MINI-ATC-5</p>	<p>512-407 10</p>  <p>MINI-ATC-7-1/2</p>	<p>512-410 10</p>  <p>MINI-ATC-10</p>	<p>512-415 10</p>  <p>MINI-ATC-15</p>	<p>512-420 10</p>  <p>MINI-ATC-20</p>
<p>512-425 10</p>  <p>MINI-ATC-25</p>	<p>512-430 10</p>  <p>MINI-ATC-30</p>	<p>512-431 10</p>  <p>MINI-ATC-35</p>	<p>512-432 10</p>  <p>MINI-ATC-40</p>	<p>512-434 5</p>  <p>2 amp Low Profile</p>	<p>512-437 5</p>  <p>5 amp Low Profile</p>	<p>512-438 5</p>  <p>7.5 amp Low Profile</p>	<p>512-439 5</p>  <p>10 amp Low Profile</p>
<p>512-440 5</p>  <p>15 amp Low Profile</p>	<p>512-442 5</p>  <p>20 amp Low Profile</p>	<p>512-443 5</p>  <p>25 amp Low Profile</p>	<p>512-444 5</p>  <p>30 amp Low Profile</p>	<p>512-445 5</p>  <p>35 amp Low Profile</p>	<p>512-446 5</p>  <p>40 amp Low Profile</p>	<p>512-150</p>  <p>Fuse Puller</p>	

PART # 0512-35

**ASSORTMENT: FUSES**

01/22

<p>512-770 1</p>  <p>20 amp J-Case Low</p>	<p>512-772 1</p>  <p>25 amp J-Case Low</p>	<p>512-774 1</p>  <p>30 amp J-Case Low</p>	<p>512-776 1</p>  <p>40 amp J-Case Low</p>	<p>512-778 1</p>  <p>50 amp J-Case Low</p>	<p>512-780 1</p>  <p>60 amp J-Case Low</p>		<p>512-798 1</p>  <p>40 amp M-Case</p>
<p>512-720 1</p>  <p>20 amp J-Case</p>	<p>512-725 1</p>  <p>25 amp J-Case</p>	<p>512-730 1</p>  <p>30 amp J-Case</p>	<p>512-740 1</p>  <p>40 amp J-Case</p>	<p>512-750 1</p>  <p>50 amp J-Case</p>	<p>512-760 1</p>  <p>60 amp J-Case</p>	<p>512-794 1</p>  <p>25 amp M-Case</p>	<p>512-796 1</p>  <p>30 amp M-Case</p>
<p>512-380 5</p>  <p>5 amp MICRO-3</p>	<p>512-381 5</p>  <p>7.5 amp MICRO-3</p>	<p>512-382 5</p>  <p>10 amp MICRO-3</p>	<p>512-383 5</p>  <p>15 amp MICRO-3</p>			<p>512-790 1</p>  <p>15 amp M-Case</p>	<p>512-792 1</p>  <p>20 amp M-Case</p>
<p>512-434 5</p>  <p>2 amp Low Profile</p>	<p>512-437 5</p>  <p>5 amp Low Profile</p>	<p>512-438 5</p>  <p>7.5 amp Low Profile</p>	<p>512-439 5</p>  <p>10 amp Low Profile</p>	<p>512-440 5</p>  <p>15 amp Low Profile</p>	<p>512-442 5</p>  <p>20 amp Low Profile</p>	<p>512-443 5</p>  <p>25 amp Low Profile</p>	<p>512-444 5</p>  <p>30 amp Low Profile</p>

PART # 0512-40

**ASSORTMENT: FUSES**

01/22

<p><b>512-904</b> 1</p>  <p>30 amp Pal 330</p>	<p><b>512-906</b> 1</p>  <p>40 amp Pal 340</p>			<p><b>512-880</b> 1</p>  <p>1120 amp Pal 1120</p>	<p><b>512-878</b> 1</p>  <p>1100 amp Pal 1100</p>
<p><b>512-890</b> 1</p>  <p>20 amp FLF Cartridge</p>	<p><b>512-892</b> 1</p>  <p>30 amp FLF Cartridge</p>	<p><b>512-894</b> 1</p>  <p>40 amp FLF Cartridge</p>	<p><b>512-896</b> 1</p>  <p>50 amp FLF Cartridge</p>	<p><b>512-898</b> 1</p>  <p>60 amp FLF Cartridge</p>	<p><b>512-876</b> 1</p>  <p>80 amp Pal 180</p>
<p><b>512-807</b> 1</p>  <p>50 amp M-Case</p>	<p><b>512-808</b> 1</p>  <p>60 amp M-Case</p>	<p><b>512-912</b> 1</p>  <p>30 amp Pal 525</p>	<p><b>512-914</b> 1</p>  <p>40 amp Pal 530</p>		<p><b>512-874</b> 1</p>  <p>60 amp Pal 160</p>
<p><b>512-801</b> 1</p>  <p>15 amp M-Case</p>	<p><b>512-802</b> 1</p>  <p>20 amp M-Case</p>	<p><b>512-803</b> 1</p>  <p>25 amp M-Case</p>	<p><b>512-804</b> 1</p>  <p>30 amp M-Case</p>	<p><b>512-806</b> 1</p>  <p>40 amp M-Case</p>	<p><b>512-872</b> 1</p>  <p>30 amp Pal 130</p>

PART # 0512-45

**ASSORTMENT: FUSES**

01/22

512-816 1



60 amp Pal 260

512-842 1



40 amp Pal 440

512-814 1



50 amp Pal 250

512-840 1



30 amp Pal 430

512-852 1



100 amp Pal 4100

512-826 1



140 amp Pal 2140

512-812 1



40 amp Pal 240

512-820 1



80 amp Pal 280

512-848 1



80 amp Pal 480

512-824 1



120 amp Pal 2120

512-810 1



30 amp Pal 230

512-818 1



70 amp Pal 270

512-844 1



50 amp Pal 450

512-822 1



100 amp Pal 2100

513-793 1



100 amp Midi Fuse

513-791 1



80 amp Midi Fuse

513-790 1



70 amp Midi Fuse

513-789 1



60 amp Midi Fuse

513-788 1



50 amp Midi Fuse

513-820



Midi

Fuse Holder

513-755



Maxi

Fuse Holder

513-770 1



175 amp Mega Fuse

513-765 1



150 amp Mega Fuse

513-763 1



125 amp Mega Fuse

513-761 1



100 amp Mega Fuse

513-758 1



60 amp Mega Fuse

513-786 1



500 amp Mega Fuse

513-782 1



300 amp Mega Fuse

513-780 1



250 amp Mega Fuse

513-775 1



200 amp Mega Fuse

PART # 0512-60

**ASSORTMENT: BREAKERS**

01/22















<p>512-596 <sup>1</sup></p>  <p>5 amp Manual</p>	<p>512-597 <sup>1</sup></p>  <p>10 amp Manual</p>	<p>512-598 <sup>1</sup></p>  <p>15 amp Manual</p>	<p>512-599 <sup>1</sup></p>  <p>20 amp Manual</p>	<p>512-605 <sup>1</sup></p>  <p>25 amp Manual</p>	<p>512-600 <sup>1</sup></p>  <p>30 amp Manual</p>		
<p>512-982 <sup>1</sup></p>  <p>5 amp Manual-Reset</p>	<p>512-983 <sup>1</sup></p>  <p>7.5 amp Manual-Reset</p>	<p>512-984 <sup>1</sup></p>  <p>10 amp Manual-Reset</p>	<p>512-985 <sup>1</sup></p>  <p>15 amp Manual-Reset</p>	<p>512-986 <sup>1</sup></p>  <p>20 amp Manual-Reset</p>	<p>512-987 <sup>1</sup></p>  <p>25 amp Manual-Reset</p>	<p>512-988 <sup>1</sup></p>  <p>30 amp Manual-Reset</p>	
<p>512-962 <sup>1</sup></p>  <p>5 amp Auto-Reset 2</p>	<p>512-963 <sup>1</sup></p>  <p>7.5 amp Auto-Reset 2</p>	<p>512-964 <sup>1</sup></p>  <p>10 amp Auto-Reset 2</p>	<p>512-965 <sup>1</sup></p>  <p>15 amp Auto-Reset 2</p>	<p>512-966 <sup>1</sup></p>  <p>20 amp Auto-Reset 2</p>	<p>512-967 <sup>1</sup></p>  <p>25 amp Auto-Reset 2</p>	<p>512-968 <sup>1</sup></p>  <p>30 amp Auto-Reset 2</p>	
<p>512-592 <sup>1</sup></p>  <p>5 amp Auto-Reset 1</p>	<p>512-593 <sup>1</sup></p>  <p>7.5 amp Auto-Reset 1</p>	<p>512-954 <sup>1</sup></p>  <p>10 amp Auto-Reset 1</p>	<p>512-955 <sup>1</sup></p>  <p>15 amp Auto-Reset 1</p>	<p>512-956 <sup>1</sup></p>  <p>20 amp Auto-Reset 1</p>	<p>512-957 <sup>1</sup></p>  <p>25 amp Auto-Reset 1</p>	<p>512-958 <sup>1</sup></p>  <p>30 amp Auto-Reset 1</p>	

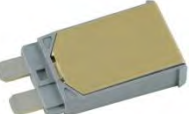
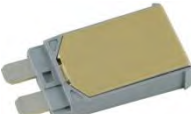

PART # 0512-65

# ASSORTMENT: BREAKERS

01/22

<p><b>512-570</b> <sub>1</sub></p>  <p><b>10 amp</b> <b>Auto-Reset</b></p>	<p><b>512-572</b> <sub>1</sub></p>  <p><b>15 amp</b> <b>Auto-Reset</b></p>	<p><b>512-575</b> <sub>1</sub></p>  <p><b>20 amp</b> <b>Auto-Reset</b></p>	<p><b>512-576</b> <sub>1</sub></p>  <p><b>30 amp</b> <b>Auto-Reset</b></p>				
<p><b>512-559</b> <sub>1</sub></p>  <p><b>10 amp</b> <b>Auto-Reset</b></p>	<p><b>512-560</b> <sub>1</sub></p>  <p><b>15 amp</b> <b>Auto-Reset</b></p>	<p><b>512-561</b> <sub>1</sub></p>  <p><b>20 amp</b> <b>Auto-Reset</b></p>	<p><b>512-563</b> <sub>1</sub></p>  <p><b>30 amp</b> <b>Auto-Reset</b></p>	<p><b>512-565</b> <sub>1</sub></p>  <p><b>40 amp</b> <b>Auto-Reset</b></p>	<p><b>512-567</b> <sub>1</sub></p>  <p><b>50 amp</b> <b>Auto-Reset</b></p>		
<p><b>512-584</b> <sub>1</sub></p>  <p><b>5 amp</b> <b>Auto-Reset</b></p>	<p><b>512-585</b> <sub>1</sub></p>  <p><b>10 amp</b> <b>Auto-Reset</b></p>	<p><b>512-986</b> <sub>1</sub></p>  <p><b>15 amp</b> <b>Auto-Reset</b></p>	<p><b>512-987</b> <sub>1</sub></p>  <p><b>20 amp</b> <b>Auto-Reset</b></p>	<p><b>512-988</b> <sub>1</sub></p>  <p><b>25 amp</b> <b>Auto-Reset</b></p>	<p><b>512-989</b> <sub>1</sub></p>  <p><b>30 amp</b> <b>Auto-Reset</b></p>		

PART # 0514-25

**ASSORTMENT: BREAKER / TOGGLE**























01/22

<p>514-240 1</p>  <p>10 AMP BREAKER</p>	<p>514-242 1</p>  <p>15 AMP BREAKER</p>	<p>514-244 1</p>  <p>20 AMP BREAKER</p>	<p>514-426 1</p>  <p>25 AMP BREAKER</p>	<p>514-248 1</p>  <p>30 AMP BREAKER</p>	<p>518-534 1</p>  <p>TWO POSITION</p>
<p>514-110 1</p>  <p>10 AMP BREAKER</p>	<p>514-112 1</p>  <p>15 AMP BREAKER</p>	<p>514-114 1</p>  <p>20 AMP BREAKER</p>	<p>514-116 1</p>  <p>30 AMP BREAKER</p>	<p>514-118 1</p>  <p>40 AMP BREAKER</p>	<p>518-592 1</p>  <p>THREE POSITION</p>
<p>514-086 1</p>  <p>15 AMP BREAKER</p>	<p>514-088 1</p>  <p>20 AMP BREAKER</p>	<p>514-090 1</p>  <p>30 AMP BREAKER</p>	<p>514-092 1</p>  <p>40 AMP BREAKER</p>		<p>518-542 1</p>  <p>UNIVERSAL PUSH PULL</p>
<p>514-056 1</p>  <p>15 AMP BREAKER</p>	<p>514-058 1</p>  <p>20 AMP BREAKER</p>	<p>514-060 1</p>  <p>25 AMP BREAKER</p>	<p>514-062 1</p>  <p>30 AMP BREAKER</p>	<p>515-315 1</p>  <p>2 PRONG FLASHER</p>	<p>515-320 1</p>  <p>3 PRONG FLASHER</p>

PART # 0535-25

**ASSORTMENT: HOSE CONNECTOR**

01/22

<p>535-293 5</p>  <p>1/8 X 3/16 RED</p>	<p>535-295 5</p>  <p>1/8 X 1/4 RED</p>	<p>535-297 5</p>  <p>3/16 X 1/4 RED</p>	<p>535-299 5</p>  <p>3/8 X 1/4 RED</p>		
<p>535-280 5</p>  <p>1/8" TEE</p>	<p>535-282 5</p>  <p>3/16" TEE</p>	<p>535-284 5</p>  <p>1/4" TEE</p>	<p>535-286 5</p>  <p>5/16" TEE</p>	<p>535-288 5</p>  <p>3/8" TEE</p>	<p>535-292 5</p>  <p>1/2" TEE</p>
<p>535-252 5</p>  <p>1/8" CONNECTOR</p>	<p>535-254 5</p>  <p>3/16" CONNECTOR</p>	<p>535-256 5</p>  <p>1/4" CONNECTOR</p>	<p>535-258 5</p>  <p>5/16" CONNECTOR</p>	<p>535-260 5</p>  <p>3/8" CONNECTOR</p>	<p>535-262 5</p>  <p>1/2" CONNECTOR</p>
<p>535-222 10</p>  <p>1/8" CAP</p>	<p>535-224 10</p>  <p>3/16" CAP</p>	<p>535-226 10</p>  <p>1/4" CAP</p>	<p>535-227 10</p>  <p>5/16" CAP</p>	<p>535-228 10</p>  <p>3/8" CAP</p>	<p>535-230 10</p>  <p>1/2" CAP</p>

PART # 0546-35

# ASSORTMENT: PULL SPRINGS

01/22

**546-420**

5



(ST-14102 / 41350) 18 1/2 LONG 13/32 O.D. 3/32 WIRE

**546-390**

5



(ST-14103 / 41351) 17 1/2 LONG 3/4 O.D. 1/16 WIRE

**546-360**

5



(ST-14097 / 41353) 11 1/2 LONG 13/32 O.D. 1/32 WIRE

**546-330**

5



(ST-14100 / 41354) 8 1/2 LONG 1 7/8 O.D. 3/32 WIRE

**546-270**

5



(ST-14104 / 41356) 8 1/4 LONG 7/16 O.D. 1/16 WIRE

**546-300**

5



(ST-14099 / 41359) 1 13/16 LONG 3/8 O.D. 1/32 WIRE

**546-210**

5



(ST-14098 / 41360) 4 3/8 LONG 1/2 O.D. 1/16 WIRE

**546-240**

5



(ST-14101 / 41357) 5 3/4 LONG 25/32 O.D. 3/64 WIRE

**PART # 0549-25**

**ASSORTMENT: GROMMETS**

01/22

<p><b>549-515</b> 10</p>  <p>DRILL: 3/4 GROOVE: 1/16 I.D. 1-1/4</p>	<p><b>549-520</b> 10</p>  <p>DRILL: 3/4 GROOVE: 1/4 I.D. 1-1/4</p>				
<p><b>549-490</b> 10</p>  <p>DRILL: 1/2 GROOVE: 1/8 I.D. 3/4</p>	<p><b>549-495</b> 10</p>  <p>DRILL: 1/2 GROOVE: 1/4 I.D. 13/16</p>	<p><b>549-500</b> 10</p>  <p>DRILL: 5/8 GROOVE: 1/16 I.D. 7/8</p>	<p><b>549-505</b> 10</p>  <p>DRILL: 5/8 GROOVE: 1/8 I.D. 7/8</p>	<p><b>549-510</b> 10</p>  <p>DRILL: 3/4 GROOVE: 1/16 I.D. 1-1/16</p>	<p><b>549-770</b> 10</p>  <p>LARGE</p>
<p><b>549-465</b> 10</p>  <p>DRILL: 3/8 GROOVE: 1/16 I.D. 1/2</p>	<p><b>549-470</b> 10</p>  <p>DRILL: 3/8 GROOVE: 1/16 I.D. 1"</p>	<p><b>549-475</b> 10</p>  <p>DRILL: 3/8 GROOVE: 1/4 I.D. 5/8</p>	<p><b>549-480</b> 10</p>  <p>DRILL: 3/8 GROOVE: 1/16 I.D. 5/8</p>	<p><b>549-485</b> 10</p>  <p>DRILL: 7/16 GROOVE: 1/16 I.D. 9/16</p>	<p><b>549-760</b> 10</p>  <p>MEDIUM</p>
<p><b>549-440</b> 10</p>  <p>DRILL: 1/8 GROOVE: 3/32 I.D. 3/8</p>	<p><b>549-445</b> 10</p>  <p>DRILL: 5/32 GROOVE: 3/32 I.D. 1/4</p>	<p><b>549-450</b> 10</p>  <p>DRILL: 3/16 GROOVE: 3/32 I.D. 9/32</p>	<p><b>549-455</b> 10</p>  <p>DRILL: 5/16 GROOVE: 1/16 I.D. 9/16</p>	<p><b>549-460</b> 10</p>  <p>DRILL: 5/16 GROOVE: 1/8 I.D. 9/16</p>	<p><b>549-750</b> 10</p>  <p>SMALL</p>



**CANTON FLEET - INDUSTRIAL SUPPLY**  
**COLUMBUS FLEET - INDUSTRIAL SUPPLY**

WWW.cfisgroup.com

(614) 332-7464

PART # 0549-50

**ASSORTMENT: GROMMETS**

01/22





















<p>549-515 10</p>  <p>DRILL: 3/4 GROOVE: 1/16 I.D. 1-1/4</p>	<p>549-520 10</p>  <p>DRILL: 3/4 GROOVE: 1/4 I.D. 1-1/4</p>				
<p>549-490 10</p>  <p>DRILL: 1/2 GROOVE: 1/8 I.D. 3/4</p>	<p>549-495 10</p>  <p>DRILL: 1/2 GROOVE: 1/4 I.D. 13/16</p>	<p>549-500 10</p>  <p>DRILL: 5/8 GROOVE: 1/16 I.D. 7/8</p>	<p>549-505 10</p>  <p>DRILL: 5/8 GROOVE: 1/8 I.D. 7/8</p>	<p>549-510 10</p>  <p>DRILL: 3/4 GROOVE: 1/16 I.D. 1-1/16</p>	
<p>549-465 10</p>  <p>DRILL: 3/8 GROOVE: 1/16 I.D. 1/2</p>	<p>549-470 10</p>  <p>DRILL: 3/8 GROOVE: 1/16 I.D. 1"</p>	<p>549-475 10</p>  <p>DRILL: 3/8 GROOVE: 1/4 I.D. 5/8</p>	<p>549-480 10</p>  <p>DRILL: 3/8 GROOVE: 1/16 I.D. 5/8</p>	<p>549-485 10</p>  <p>DRILL: 7/16 GROOVE: 1/16 I.D. 9/16</p>	
<p>549-440 10</p>  <p>DRILL: 1/8 GROOVE: 3/32 I.D. 3/8</p>	<p>549-445 10</p>  <p>DRILL: 5/32 GROOVE: 3/32 I.D. 1/4</p>	<p>549-450 10</p>  <p>DRILL: 3/16 GROOVE: 3/32 I.D. 9/32</p>	<p>549-455 10</p>  <p>DRILL: 5/16 GROOVE: 1/16 I.D. 9/16</p>	<p>549-460 10</p>  <p>DRILL: 5/16 GROOVE: 1/8 I.D. 9/16</p>	



**PART # 0549-75**

# ASSORTMENT: CAP PLUGS



















01/22

<p><b>549-880</b> 10</p>  <p><b>1-1/4 PLUG</b></p>					<p><b>549-888</b> 10</p>  <p><b>2" PLUG</b></p>
<p><b>549-870</b> 10</p>  <p><b>7/8 PLUG</b></p>	<p><b>549-872</b> 10</p>  <p><b>13/16 PLUG</b></p>	<p><b>549-874</b> 10</p>  <p><b>1" PLUG</b></p>	<p><b>549-876</b> 10</p>  <p><b>1-1/32 PLUG</b></p>	<p><b>549-878</b> 10</p>  <p><b>1-3/16 PLUG</b></p>	<p><b>549-886</b> 10</p>  <p><b>1-3/4 PLUG</b></p>
<p><b>549-860</b> 10</p>  <p><b>1/2 PLUG</b></p>	<p><b>549-862</b> 10</p>  <p><b>9/16 PLUG</b></p>	<p><b>549-864</b> 10</p>  <p><b>5/8 PLUG</b></p>	<p><b>549-866</b> 10</p>  <p><b>3/4 PLUG</b></p>	<p><b>549-868</b> 10</p>  <p><b>11/16 PLUG</b></p>	<p><b>549-884</b> 10</p>  <p><b>1-1/2 PLUG</b></p>
<p><b>549-850</b> 10</p>  <p><b>3/16 PLUG</b></p>	<p><b>549-852</b> 10</p>  <p><b>1/4 PLUG</b></p>	<p><b>549-854</b> 10</p>  <p><b>5/16 PLUG</b></p>	<p><b>549-856</b> 10</p>  <p><b>3/8 PLUG</b></p>	<p><b>549-858</b> 10</p>  <p><b>7/16 PLUG</b></p>	<p><b>549-882</b> 10</p>  <p><b>1-3/8 PLUG</b></p>

**PART # 0555-25**

**ASSORTMENT: BODY RETAINERS**













01/22

<p><b>AV15970</b> 12</p>  <p>HEAD: 9/16 X 11/16" STEM: 3/4" HOLE: 5/16"</p>	<p><b>AV11678</b> 12</p>  <p>HEAD: 15/16" STEM: 11/16" HOLE: 5/16"</p>	<p><b>AV12737</b> 25</p>  <p>HEAD: 3/4" STEM: 3/4" HOLE: 5/16"</p>			<p><b>AV11796</b> 25</p>  <p>HEAD: 7/8" STEM: 3/4" HOLE: 5/16"</p>
<p><b>AV17612</b> 12</p>  <p>HEAD: 5/8" STEM: 3/4" HOLE: 3/8"</p>	<p><b>AV12909</b> 12</p>  <p>HEAD: 1" STEM: 1-1/16" HOLE: 9/32"</p>				<p><b>AV20192</b> 12</p>  <p>HEAD: 11/16" STEM: 1-3/4" HOLE: 5/16"</p>
<p><b>AV12766</b> 12</p>  <p>HEAD: 7/8" STEM: 13/16" HOLE: 7/16"</p>	<p><b>AV12571</b> 12</p>  <p>HEAD: 1" STEM: 13/16" HOLE: 5/16"</p>	<p><b>AV12137</b> 12</p>  <p>HEAD: 1" STEM: 13/16" HOLE: 7/16"</p>	<p><b>AV12565</b> 12</p>  <p>HEAD: 25/32" STEM: 5/8" HOLE: 5/16"</p>	<p><b>AV11671</b> 12</p>  <p>HEAD: 5/8" STEM: 1-1/8" HOLE: 11/32"</p>	<p><b>AV15414</b> 25</p>  <p>HEAD: 11/16" STEM: 13/16" HOLE: 5/16"</p>
<p><b>AV17339</b> 25</p>  <p>HEAD: 5 mm STEM: 12 mm HOLE: 4 mm</p>	<p><b>AV14757</b> 12</p>  <p>HEAD: 1/2" STEM: 15/16" HOLE: 1/4"</p>	<p><b>AV11351</b> 12</p>  <p>HEAD: 15/16" STEM: 11/16" HOLE: 5/16"</p>	<p><b>AV16818</b> 12</p>  <p>HEAD: 3/4" STEM: 7/8" HOLE: 5/16"</p>	<p><b>AV17664</b> 25</p>  <p>HEAD: 11/16" STEM: 1-1/16" HOLE: 5/16"</p>	<p><b>AV11136</b> 12</p>  <p>HEAD: 1/2 X 1-1/2" STEM: 5/8" HOLE: 9/32"</p>

PART # 0555-40

**ASSORTMENT: BODY RETAINERS**

01/22

				<p><b>AV14010</b> 12</p>  <p>HEAD: 25.4 mm STEM: 18.3 mm HOLE: 9.5 mm</p>
<p><b>AV20994</b> 12</p>  <p>HEAD: 25 mm STEM: 23 mm HOLE: 10.5 mm</p>				<p><b>AV12757</b> 12</p>  <p>HEAD: 25.4 mm STEM: 7 mm HOLE: 5 mm</p>
<p><b>AV20989</b> 12</p>  <p>HEAD: 18 mm STEM: 22 mm HOLE: 6.5 mm</p>	<p><b>AV20988</b> 12</p>  <p>HEAD: 18 mm STEM: 17.5 mm HOLE: 6.5 mm"</p>	<p><b>AV20889</b> 12</p>  <p>HEAD: 20 mm STEM: 22 mm HOLE: 8.5 mm</p>	<p><b>AV20880</b> 12</p>  <p>HEAD: 18 mm STEM: 20 mm HOLE: 6.5 mm</p>	<p><b>AV20993</b> 12</p>  <p>HEAD: 25 mm STEM: 20 mm HOLE: 10.5 mm</p>
<p><b>AV20888</b> 12</p>  <p>HEAD: 18 mm STEM: 20 mm HOLE: 9.5 mm</p>	<p><b>AV20990</b> 12</p>  <p>HEAD: 19 mm STEM: 16 mm HOLE: 8 mm"</p>	<p><b>AV20991</b> 12</p>  <p>HEAD: 20 mm STEM: 20 mm HOLE: 8.5 mm</p>	<p><b>AV20992</b> 12</p>  <p>HEAD: 20 mm STEM: 24 mm HOLE: 8.5 mm</p>	<p><b>AV20826</b> 12</p>  <p>HEAD: 19 mm STEM: 14 mm HOLE: 8.5 mm</p>

**PART # 0581-25**

**ASSORTMENT: BLACK PIPE**

01/22































<p>581-004 2</p>  <p>1/2 P PLUG</p>	<p>581-044 2</p>  <p>1/2 P COUPLER</p>	<p>581-101 2</p>  <p>1/8 P TEE</p>	<p>581-102 2</p>  <p>1/4 P TEE</p>	<p>581-103 2</p>  <p>3/8 P TEE</p>	<p>581-104 1</p>  <p>1/2 P TEE</p>
<p>581-003 2</p>  <p>3/8 P PLUG</p>	<p>581-043 2</p>  <p>3/8 P COUPLER</p>	<p>581-121 2</p>  <p>1/8 P 90 M/F</p>	<p>581-122 2</p>  <p>1/4 P 90 M/F</p>	<p>581-123 2</p>  <p>3/8 P 90 M/F</p>	<p>581-124 1</p>  <p>1/2 P 90 M/F</p>
<p>581-002 3</p>  <p>1/4 P PLUG</p>	<p>581-042 3</p>  <p>1/4 P COUPLER</p>	<p>581-141 2</p>  <p>1/8 P 45 M/F</p>	<p>581-142 2</p>  <p>1/4 P 45 M/F</p>	<p>581-143 2</p>  <p>3/8 P 45 M/F</p>	<p>581-144 1</p>  <p>1/2 P 45 M/F</p>
<p>581-001 4</p>  <p>1/8 P PLUG</p>	<p>581-041 4</p>  <p>1/8 P COUPLER</p>	<p>581-161 2</p>  <p>1/8 P 90 F/F</p>	<p>581-162 2</p>  <p>1/4 P 90 F/F</p>	<p>581-163 2</p>  <p>3/8 P 90 F/F</p>	<p>581-164 1</p>  <p>1/2 P 90 F/F</p>

PART # 0581-30

**ASSORTMENT: BLACK PIPE**

01/22





<p>581-206 2</p>  <p>3/8 X 1/2</p>	<p>2</p>	<p>581-302 2</p>  <p>1/8 X 1-1/2</p>	<p>581-322 2</p>  <p>1/4 X 1-1/2</p>	<p>581-343 2</p>  <p>3/8 X 2"</p>	<p>581-363 2</p>  <p>1/2 X 2"</p>
<p>581-203 2</p>  <p>1/4 X 3/8</p>	<p>2</p>	<p>581-301 2</p>  <p>1/8 P NIPPLE</p>	<p>581-321 2</p>  <p>1/4 P NIPPLE</p>	<p>581-341 2</p>  <p>3/8 P NIPPLE</p>	<p>581-361 2</p>  <p>1/2 P NIPPLE</p>
<p>581-202 3</p>  <p>1/8 X 3/8</p>	<p>581-215 3</p>  <p>3/4 X 1"</p>	<p>581-241 2</p>  <p>1/8 X 1/4</p>	<p>581-243 2</p>  <p>1/4 X 3/8</p>	<p>581-246 2</p>  <p>3/8 X 1/2</p>	<p>581-250 1</p>  <p>1/2 X 3/4</p>
<p>581-201 4</p>  <p>1/8 X 1/4</p>	<p>581-210 4</p>  <p>1/2 X 3/4</p>	<p>581-021 2</p>  <p>1/8 P CAP</p>	<p>581-022 2</p>  <p>1/4 P CAP</p>	<p>581-023 2</p>  <p>3/8 P CAP</p>	<p>581-024 2</p>  <p>1/2 P CAP</p>

<p>607-310 2</p>  <p>1/8T X 1/8P</p>	<p>607-312 2</p>  <p>3/16T X 1/8P</p>	<p>607-314 2</p>  <p>1/4T X 1/8P</p>	<p>607-316 2</p>  <p>1/4T X 1/4P</p>	<p>607-318 2</p>  <p>5/16T X 1/8P</p>	<p>607-320 2</p>  <p>5/16T X 1/4P</p>	<p>607-324 2</p>  <p>3/8T X 1/4P</p>	<p>607-326 2</p>  <p>3/8T X 3/8P</p>
<p>607-350 2</p>  <p>1/8T X 1/8P</p>	<p>607-352 2</p>  <p>3/16T X 1/8P</p>	<p>607-354 2</p>  <p>1/4T X 1/8P</p>	<p>607-356 2</p>  <p>1/4T X 1/4P</p>	<p>607-358 2</p>  <p>5/16T X 1/8P</p>	<p>607-360 2</p>  <p>5/16T X 1/4P</p>	<p>607-364 2</p>  <p>3/8T X 1/4P</p>	<p>607-340 2</p>  <p>1/2T X 3/8P</p>
<p>607-282 2</p>  <p>1/8 UNION</p>	<p>607-284 2</p>  <p>3/16 UNION</p>	<p>607-286 2</p>  <p>1/4 UNION</p>	<p>607-288 2</p>  <p>5/16 UNION</p>	<p>607-290 2</p>  <p>3/8 UNION</p>	<p>607-264 2</p>  <p>1/2 UNION</p>		<p>607-366 2</p>  <p>3/8T X 3/8P</p>
<p>607-252 2</p>  <p>1/8 NUT</p>	<p>607-254 2</p>  <p>3/16 NUT</p>	<p>607-256 2</p>  <p>1/4 NUT</p>	<p>607-258 2</p>  <p>5/16 NUT</p>	<p>607-260 2</p>  <p>3/8 NUT</p>	<p>607-264 2</p>  <p>1/2 NUT</p>	<p>607-266 2</p>  <p>5/8 NUT</p>	<p>607-380 2</p>  <p>1/2T X 3/8P</p>

**PART # 0611-25**

**ASSORTMENT: HOSE BARBS**

01/22

<p>611-049 2</p>  <p>5/8H - 3/8P</p>	<p>611-050 2</p>  <p>5/8H - 1/2P</p>	<p>611-052 2</p>  <p>3/4H - 1/2P</p>			<p>611-188 2</p>  <p>5/8H - 1/2P</p>
<p>611-008 2</p>  <p>1/2 HOSE</p>	<p>610-008 2</p>  <p>1/2 HOSE</p>	<p>611-044 2</p>  <p>1/2H - 1/4P</p>	<p>611-045 2</p>  <p>1/2H - 3/8P</p>	<p>611-046 2</p>  <p>1/2H - 1/2P</p>	
<p>611-006 2</p>  <p>3/8 HOSE</p>	<p>610-006 2</p>  <p>3/8 HOSE</p>	<p>611-039 2</p>  <p>3/8H - 1/8P</p>	<p>611-040 2</p>  <p>3/8H - 1/4P</p>	<p>611-041 2</p>  <p>3/8H - 3/8P</p>	<p>610-012 2</p>  <p>3/4 HOSE</p>
<p>611-004 2</p>  <p>1/4 HOSE</p>	<p>610-004 2</p>  <p>1/4 HOSE</p>	<p>611-033 2</p>  <p>1/4H - 1/8P</p>	<p>611-034 2</p>  <p>1/4H - 1/4P</p>		<p>610-010 2</p>  <p>5/8 HOSE</p>

PART # 0621-25

**ASSORTMENT: PIPE BRASS**



01/22

<p>621-005 2</p>  <p>1/2 P PLUG</p>	<p>621-045 2</p>  <p>1/2 P COUPLER</p>	<p>621-182 2</p>  <p>1/8 - 1/4 BSH</p>	<p>621-186 2</p>  <p>1/4 - 3/8 BSH</p>	<p>621-192 2</p>  <p>3/8 - 1/2 BSH</p>	<p>621-196 2</p>  <p>1/2 - 3/4 BSH</p>
<p>621-004 2</p>  <p>3/8 P PLUG</p>	<p>621-044 2</p>  <p>3/8 P COUPLER</p>	<p>621-082 2</p>  <p>1/8 P 90 M/F</p>	<p>621-083 2</p>  <p>1/4 P 90 M/F</p>	<p>621-084 2</p>  <p>3/8 P 90 M/F</p>	<p>621-085 2</p>  <p>1/2 P 90 M/F</p>
<p>621-003 2</p>  <p>1/4 P PLUG</p>	<p>621-043 2</p>  <p>1/4 P COUPLER</p>	<p>621-152 2</p>  <p>1/8 CLOSE</p>	<p>621-153 2</p>  <p>1/4 CLOSE</p>	<p>621-154 2</p>  <p>3/8 CLOSE</p>	<p>621-156 2</p>  <p>1/2 CLOSE</p>
<p>621-002 2</p>  <p>1/8 P PLUG</p>	<p>621-042 2</p>  <p>1/8 P COUPLER</p>	<p>621-060 2</p>  <p>1/8 P 90 F/F</p>	<p>621-061 2</p>  <p>1/4 P 90 F/F</p>	<p>621-062 2</p>  <p>3/8 P 90 F/F</p>	<p>621-063 2</p>  <p>1/2 P 90 F/F</p>

PART # 0621-30

**ASSORTMENT: PIPE BRASS**



01/22

<p>621-055 1</p> <p>1/2 TEE</p>	<p>621-105 2</p> <p>1/2 P 45 M/F</p>	<p>621-145 2</p> <p>1/2 HEX NIPPLE</p>	<p>621-208 2</p> <p>3/8 X 1/4 ADPT</p>	<p>621-214 2</p> <p>1/2 X 3/8 ADPT</p>	<p>621-095 1</p> <p>1/2 RUN</p>
<p>621-054 1</p> <p>3/8 TEE</p>	<p>621-104 2</p> <p>3/8 P 45 M/F</p>	<p>621-144 2</p> <p>3/8 HEX NIPPLE</p>	<p>621-206 2</p> <p>1/4 X 1/4 ADPT</p>	<p>621-210 2</p> <p>3/8 X 3/8 ADPT</p>	<p>621-094 1</p> <p>3/8 RUN</p>
<p>621-053 1</p> <p>1/4 TEE</p>	<p>621-103 2</p> <p>1/4 P 45 FMF</p>	<p>621-143 2</p> <p>1/4 HEX NIPPLE</p>	<p>621-204 2</p> <p>1/4 X 1/8 ADPT</p>	<p>621-191 2</p> <p>1/4 - 1/2 BSH</p>	<p>621-093 1</p> <p>1/4 RUN</p>
<p>621-052 1</p> <p>1/8 TEE</p>	<p>621-102 2</p> <p>1/8 P 45 M/F</p>	<p>621-142 2</p> <p>1/8 HEX NIPPLE</p>	<p>621-202 2</p> <p>1/8 X 1/8 ADPT</p>	<p>621-185 2</p> <p>1/8 - 3/8 BSH</p>	<p>621-092 1</p> <p>1/8 RUN</p>

PART # 0621-32

**ASSORTMENT: 3/4 PIPE BRASS**

01/22

621-056

1



3/4 TEE

621-086

1



3/4 P 90 M/F

621-195

1



3/4 - 3/8 BSH

621-046

1



1/2 P COUPLER

621-219

1



3/4 X 1/2 ADPT

621-157

1



3/4 CLOSE

621-006

1



3/4 P PLUG

621-064

1



3/4 P 90 F/F

621-146

1























3/4 HEX NIPPLE

PART # 0621-35

**ASSORTMENT: PIPE BRASS**



01/22





















<p>621-005 2</p>  <p>1/2 P PLUG</p>	<p>621-045 2</p>  <p>1/2 P COUPLER</p>	<p>621-085 2</p>  <p>1/2 P 90 M/F</p>	<p>621-145 2</p>  <p>1/2 HEX NIPPLE</p>	<p>621-196 2</p>  <p>1/2 - 3/4 BSH</p>	
<p>621-004 2</p>  <p>3/8 P PLUG</p>	<p>621-044 2</p>  <p>3/8 P COUPLER</p>	<p>621-084 2</p>  <p>3/8 P 90 M/F</p>	<p>621-144 2</p>  <p>3/8 HEX NIPPLE</p>	<p>621-192 2</p>  <p>3/8 - 1/2 BSH</p>	
<p>621-003 2</p>  <p>1/4 P PLUG</p>	<p>621-043 2</p>  <p>1/4 P COUPLER</p>	<p>621-083 2</p>  <p>1/4 P 90 M/F</p>	<p>621-143 2</p>  <p>1/4 HEX NIPPLE</p>	<p>621-186 2</p>  <p>1/4 - 3/8 BSH</p>	
<p>621-002 2</p>  <p>1/8 P PLUG</p>	<p>621-042 2</p>  <p>1/8 P COUPLER</p>	<p>621-082 2</p>  <p>1/8 P 90 M/F</p>	<p>621-142 2</p>  <p>1/8 HEX NIPPLE</p>	<p>621-182 2</p>  <p>1/8 - 1/4 BSH</p>	

PART # 0621-45

**ASSORTMENT: PIPE BRASS**

















01/22

<p>621-196 2</p>  <p>1/2 - 3/4 BSH</p>	<p>621-195 2</p>  <p>3/8 - 3/4 BSH</p>	<p>621-208 2</p>  <p>3/8 X 1/4 ADPT</p>	<p>621-214 2</p>  <p>1/2 X 3/8 ADPT</p>	<p>621-156 2</p>  <p>1/2 CLOSE</p>	<p>621-145 2</p>  <p>1/2 HEX NIPPLE</p>
<p>621-192 2</p>  <p>3/8 - 1/2 BSH</p>	<p>621-191 2</p>  <p>1/4 - 1/2 BSH</p>	<p>621-206 2</p>  <p>1/4 X 1/4 ADPT</p>	<p>621-210 2</p>  <p>3/8 X 3/8 ADPT</p>	<p>621-154 2</p>  <p>3/8 CLOSE</p>	<p>621-144 2</p>  <p>3/8 HEX NIPPLE</p>
<p>621-186 2</p>  <p>1/4 - 3/8 BSH</p>		<p>621-204 2</p>  <p>1/4 X 1/8 ADPT</p>		<p>621-153 2</p>  <p>1/4 CLOSE</p>	<p>621-143 2</p>  <p>1/4 HEX NIPPLE</p>
<p>621-182 2</p>  <p>1/8 - 1/4 BSH</p>	<p>621-185 2</p>  <p>1/8 - 3/8 BSH</p>	<p>621-202 2</p>  <p>1/8 X 1/8 ADPT</p>		<p>621-152 2</p>  <p>1/8 CLOSE</p>	<p>621-142 2</p>  <p>1/8 HEX NIPPLE</p>

PART # 0625-20

**ASSORTMENT: COMPRESSION BRASS**

























01/22

<p>625-042 10</p>  <p>1/8 INSERT</p>		<p>625-044 10</p>  <p>3/16 INSERT</p>	<p>625-046 10</p>  <p>1/4 INSERT</p>	<p>625-048 10</p>  <p>5/16 INSERT</p>	<p>615-050 10</p>  <p>3/8 INSERT</p>
<p>625-024 10</p>  <p>3/16 SLEEVE</p>	<p>625-004 5</p>  <p>3/16 NUT</p>	<p>625-128 2</p>  <p>3/16T X 1/8P</p>	<p>625-129 2</p>  <p>3/16T X 1/4P</p>	<p>625-168 2</p>  <p>3/16T X 1/8P</p>	<p>625-104 2</p>  <p>3/16T UNION</p>
<p>625-023 10</p>  <p>5/32 SLEEVE</p>		<p>625-126 2</p>  <p>5/32T X 1/8P</p>		<p>625-167 2</p>  <p>5/32T X 1/8P</p>	<p>625-103 2</p>  <p>5/32T UNION</p>
<p>625-022 10</p>  <p>1/8 SLEEVE</p>	<p>625-002 5</p>  <p>1/8 NUT</p>	<p>625-123 2</p>  <p>1/8T X 1/16P</p>	<p>625-124 2</p>  <p>1/8T X 1/8P</p>	<p>625-164 2</p>  <p>1/8T X 1/8P</p>	<p>625-102 2</p>  <p>1/8T UNION</p>

PART # 0625-25

**ASSORTMENT: COMPRESSION BRASS**











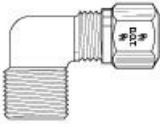
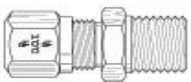
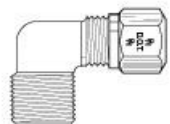
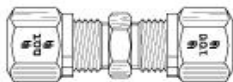
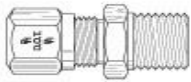

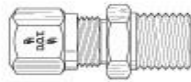
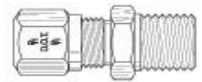
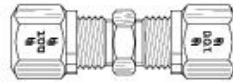
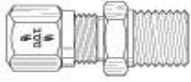

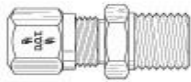
01/22

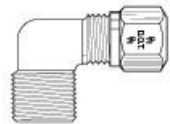
<p>625-029 10</p>  <p>3/8 SLEEVE</p>	<p>625-010 5</p>  <p>3/8 NUT</p>	<p>625-137 2</p>  <p>3/8T X 1/4P</p>	<p>625-138 2</p>  <p>3/8T X 3/8P</p>	<p>625-177 2</p>  <p>3/8T X 1/4P</p>	<p>625-110 2</p>  <p>3/8T UNION</p>
<p>625-028 10</p>  <p>5/16 SLEEVE</p>	<p>625-008 5</p>  <p>5/16 NUT</p>	<p>625-133 2</p>  <p>5/16T X 1/8P</p>	<p>625-134 2</p>  <p>5/16T X 1/4P</p>	<p>625-174 2</p>  <p>5/16T X 1/4P</p>	<p>625-108 2</p>  <p>5/16T UNION</p>
<p>625-026 10</p>  <p>1/4 SLEEVE</p>	<p>625-006 5</p>  <p>1/4 NUT</p>	<p>625-130 2</p>  <p>1/4T X 1/8P</p>	<p>625-131 2</p>  <p>1/4T X 1/4P</p>	<p>625-170 2</p>  <p>1/4T X 1/8P</p>	<p>625-106 2</p>  <p>1/4T UNION</p>
<p>625-024 10</p>  <p>3/16 SLEEVE</p>	<p>625-004 5</p>  <p>3/16 NUT</p>	<p>625-128 2</p>  <p>3/16T X 1/8P</p>	<p>625-129 2</p>  <p>3/16T X 1/4P</p>	<p>625-168 2</p>  <p>3/16T X 1/8P</p>	<p>625-104 2</p>  <p>3/16T UNION</p>

**PART # 0631-20**

**ASSORTMENT: NTA BRASS**

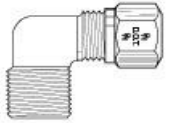

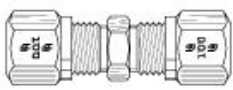







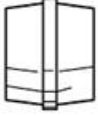

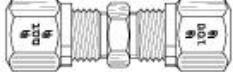
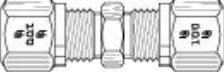
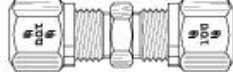

01/22

<p><b>631-050</b> 5</p>  <p><b>1/8T X 1/8P 90</b></p>	<p><b>631-034</b> 2</p>  <p><b>1/8T X 1/8P</b></p>	<p><b>631-054</b> 2</p>  <p><b>5/32T X 1/8P 90</b></p>	<p><b>631-024</b> 2</p>  <p><b>5/32 UNION</b></p>	<p><b>631-038</b> 2</p>  <p><b>5/32T X 1/8P</b></p>	<p><b>631-452</b> 2</p>  <p><b>1/4T X 1/4P</b></p>
<p><b>631-244</b> 5</p>  <p><b>1/4 INSERT</b></p>	<p><b>631-314</b> 2</p>  <p><b>1/4T X 3/8P</b></p>	<p><b>631-030</b> 2</p>  <p><b>1/8T X 1/16P</b></p>	<p><b>631-020</b> 2</p>  <p><b>1/8 UNION</b></p>	<p><b>631-036</b> 2</p>  <p><b>5/32T X 1/16P</b></p>	<p><b>631-450</b> 2</p>  <p><b>1/4T X 1/8P</b></p>
<p><b>631-224</b> 5</p>  <p><b>1/4 SLEEVE</b></p>	<p><b>631-312</b> 2</p>  <p><b>1/4T X 1/4P</b></p>	<p><b>631-422</b> 2</p>  <p><b>1/4T X 1/4P</b></p>	<p><b>631-352</b> 2</p>  <p><b>1/4T X 1/4P 90</b></p>	<p><b>631-382</b> 2</p>  <p><b>1/4T X 1/4P</b></p>	<p><b>631-544</b> 2</p>  <p><b>1/4 UNION TEE</b></p>
<p><b>631-204</b> 2</p>  <p><b>1/4 NUT</b></p>	<p><b>631-310</b> 2</p>  <p><b>1/4T X 1/8P</b></p>	<p><b>631-420</b> 2</p>  <p><b>1/4T X 1/8P</b></p>	<p><b>631-350</b> 2</p>  <p><b>1/4T X 1/8P 90</b></p>	<p><b>631-380</b> 2</p>  <p><b>1/4T X 1/8P</b></p>	<p><b>631-274</b> 2</p>  <p><b>1/4 UNION</b></p>

PART # 0631-75

**ASSORTMENT: NTA BRASS**

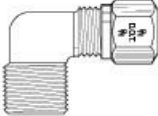

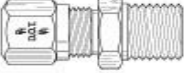
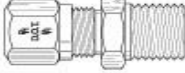
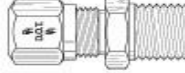
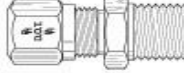
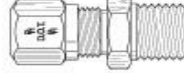
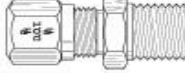









01/22

<p>631-208 5</p>  <p>1/2 NUT</p>	<p>631-228 10</p>  <p>1/2 SLEEVE</p>	<p>631-248 10</p>  <p>1/2 INSERT</p>	<p>631-274 2</p>  <p>1/4 UNION</p>	<p>631-276 2</p>  <p>3/8 UNION</p>	<p>631-278 2</p>  <p>1/2 UNION</p>
<p>631-206 5</p>  <p>3/8 NUT</p>	<p>631-226 10</p>  <p>3/8 SLEEVE</p>	<p>631-246 10</p>  <p>3/8 INSERT</p>	<p>631-350 2</p>  <p>1/4T X 1/8P 90</p>	<p>631-358 2</p>  <p>3/8T X 1/4P 90</p>	<p>631-366 2</p>  <p>1/2T X 3/8P 90</p>
<p>631-204 5</p>  <p>1/4 NUT</p>	<p>631-224 10</p>  <p>1/4 SLEEVE</p>	<p>631-244 10</p>  <p>1/4 INSERT</p>	<p>631-352 2</p>  <p>1/4T X 1/4P 90</p>	<p>631-360 2</p>  <p>3/8T X 3/8P 90</p>	<p>631-368 2</p>  <p>1/2T X 1/2P 90</p>
<p>631-310 2</p>  <p>1/4T X 1/8P</p>	<p>631-312 2</p>  <p>1/4T X 1/4P</p>	<p>631-318 2</p>  <p>3/8T X 1/4P</p>	<p>631-320 2</p>  <p>3/8T X 3/8P</p>	<p>631-326 2</p>  <p>1/2T X 3/8P</p>	<p>631-328 2</p>  <p>1/2T X 1/2P</p>

PART # 0631-80

**ASSORTMENT: NTA BRASS**

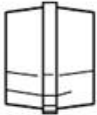
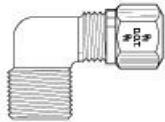
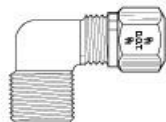
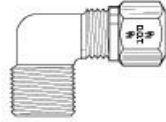

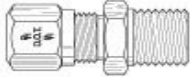
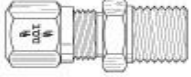
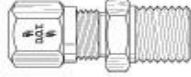
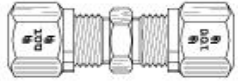









01/22

<p>631380 1</p>  <p>1/4T X 1/8P</p>	<p>631382 1</p>  <p>1/4T X 1/4P</p>	<p>631422 2</p>  <p>1/4T X 1/4P</p>	<p>631450 1</p>  <p>1/4T X 1/8P</p>	<p>631452 1</p>  <p>1/4T X 1/4P</p>
<p>631244 10</p>  <p>1/4 INSERT</p>	<p>631564 1</p>  <p>1/4 UNION ELBOW</p>	<p>631420 2</p>  <p>1/4T X 1/8P</p>	<p>631511 1</p>  <p>1/4T X 1/8P</p>	<p>631512 1</p>  <p>1/4T X 1/4P</p>
<p>631224 10</p>  <p>1/4 SLEEVE</p>	<p>631350 2</p>  <p>1/4T X 1/8P 90</p>	<p>631352 2</p>  <p>1/4T X 1/4P 90</p>	<p>631354 2</p>  <p>1/4T X 3/8P 90</p>	<p>631544 1</p>  <p>1/4 UNION TEE</p>
<p>631204 10</p>  <p>1/4 NUT</p>	<p>631310 2</p>  <p>1/4T X 1/8P</p>	<p>631312 2</p>  <p>1/4T X 1/4P</p>	<p>631314 2</p>  <p>1/4T X 3/8P</p>	<p>631274 2</p>  <p>1/4 UNION</p>

PART # 0631-82

**ASSORTMENT: NTA BRASS**

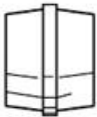
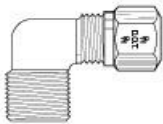
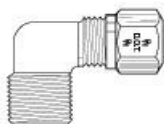
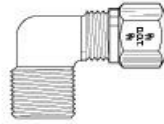

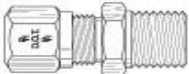
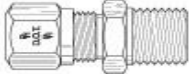
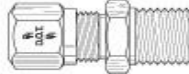
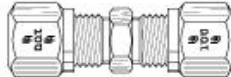







01/22

<p>631386 1</p>  <p>3/8T X 1/8P</p>	<p>631388 1</p>  <p>3/8T X 1/4P</p>	<p>631390 1</p>  <p>3/8T X 3/8P</p>	<p>631518 1</p>  <p>3/8T X 1/4P</p>	<p>631520 1</p>  <p>3/8T X 3/8P</p>
<p>631246 10</p>  <p>3/8 INSERT</p>	<p>631566 1</p>  <p>3/8 UNION ELBOW</p>	<p>631466 1</p>  <p>3/8T X 1/8P</p>	<p>631468 1</p>  <p>3/8T X 1/4P</p>	<p>631470 1</p>  <p>3/8T X 3/8P</p>
<p>631226 10</p>  <p>3/8 SLEEVE</p>	<p>631356 2</p>  <p>3/8T X 1/8P 90</p>	<p>631358 2</p>  <p>3/8T X 1/4P 90</p>	<p>631360 2</p>  <p>3/8T X 3/8P 90</p>	<p>631546 1</p>  <p>3/8 UNION TEE</p>
<p>631206 10</p>  <p>3/8 NUT</p>	<p>631316 2</p>  <p>3/8T X 1/8P</p>	<p>631318 2</p>  <p>3/8T X 1/4P</p>	<p>631320 2</p>  <p>3/8T X 3/8P</p>	<p>631276 2</p>  <p>3/8 UNION</p>

PART # 0631-84

**ASSORTMENT: NTA BRASS**

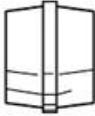
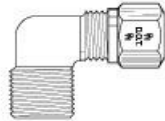
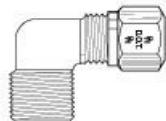
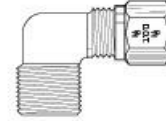

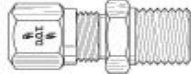
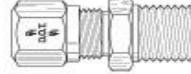
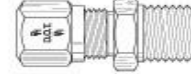
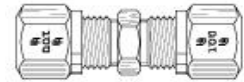





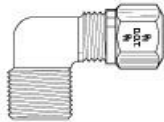

01/22

<p>631394 1</p>  <p>1/2T X 1/4P</p>	<p>631396 1</p>  <p>1/2T X 3/8P</p>	<p>631398 1</p>  <p>1/2T X 1/2P</p>	<p>631486 1</p>  <p>1/2T X 3/8P</p>	<p>631488 1</p>  <p>1/2T X 1/2P</p>
<p>631248 10</p>  <p>1/2 INSERT</p>	<p>631568 1</p>  <p>1/2 UNION ELBOW</p>	<p>631526 1</p>  <p>1/2T X 3/8P</p>	<p>631528 1</p>  <p>1/2T X 1/2P</p>	
<p>631228 10</p>  <p>1/2 SLEEVE</p>	<p>631364 2</p>  <p>1/2T X 1/4P 90</p>	<p>631366 2</p>  <p>1/2T X 3/8P 90</p>	<p>631368 2</p>  <p>1/2T X 1/2P 90</p>	<p>631548 1</p>  <p>1/2 UNION TEE</p>
<p>631208 5</p>  <p>1/2 NUT</p>	<p>631324 2</p>  <p>1/2T X 1/4P</p>	<p>631326 2</p>  <p>1/2T X 3/8P</p>	<p>631328 2</p>  <p>1/2T X 1/2P</p>	<p>631278 2</p>  <p>1/2 UNION</p>

PART # 0631-86

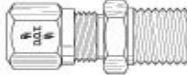
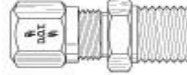
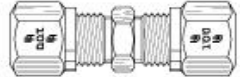
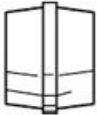
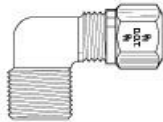
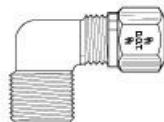
**ASSORTMENT: NTA BRASS**

01/22

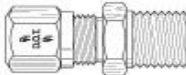
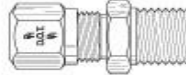
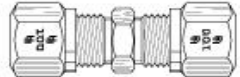
<p>631232 5</p>  <p>3/4 SLEEVE</p>	<p>631376 1</p>  <p>3/4T X 1/2P 90</p>	<p>631378 1</p>  <p>3/4T X 3/4P 90</p>		<p>631552 1</p>  <p>3/4 UNION TEE</p>
<p>631212 2</p>  <p>3/4 NUT</p>	<p>631252 5</p>  <p>3/4 INSERT</p>	<p>631337 1</p>  <p>3/4T X 1/2P</p>	<p>631338 1</p>  <p>3/4T X 3/4P</p>	<p>631282 1</p>  <p>3/4 UNION</p>
<p>631230 5</p>  <p>5/8 SLEEVE</p>	<p>631370 1</p>  <p>5/8T X 3/8P 90</p>	<p>631372 1</p>  <p>5/8T X 1/2P 90</p>	<p>631412 1</p>  <p>5/8T X 1/2P</p>	<p>631550 1</p>  <p>5/8 UNION TEE</p>
<p>631210 2</p>  <p>5/8 NUT</p>	<p>631250 5</p>  <p>5/8 INSERT</p>	<p>631330 1</p>  <p>5/8T X 3/8P</p>	<p>631332 1</p>  <p>5/8T X 1/2P</p>	<p>631280 1</p>  <p>5/8 UNION</p>

PART # 0641-25

**ASSORTMENT: PUSH-TO CONNECT**

01/22

<p>641-208 1</p>  <p>1/2T UNION</p>	<p>641-244 1</p>  <p>1/2T X 1/4P</p>	<p>641-246 1</p>  <p>1/2T X 3/8P</p>	<p>641-248 1</p>  <p>1/2T X 1/2P</p>	<p>641-286 1</p>  <p>1/2T X 3/8P 90*</p>	<p>641-287 1</p>  <p>1/2T X 1/2P 90*</p>
<p>641-206 2</p>  <p>3/8T UNION</p>	<p>641-234 2</p>  <p>3/8T X 1/4P</p>	<p>641-236 2</p>  <p>3/8T X 3/8P</p>	<p>641-274 1</p>  <p>3/8T X 1/4P 90*</p>	<p>641-276 1</p>  <p>3/8T X 3/8P 90*</p>	
<p>641-204 2</p>  <p>1/4T UNION</p>	<p>641-224 2</p>  <p>1/4T X 1/8P</p>	<p>641-228 2</p>  <p>1/4T X 1/4P</p>	<p>641-262 2</p>  <p>1/4T X 1/8P 90*</p>	<p>641-264 2</p>  <p>1/4T X 1/4P 90*</p>	<p>641-140 2</p>  <p>5/32T X 1/8P 90*</p>
<p>641-102 2</p>  <p>1/8T UNION</p>	<p>641-112 2</p>  <p>1/8T X 1/16P</p>	<p>641-116 2</p>  <p>1/8T X 1/8P</p>	<p>641-132 2</p>  <p>1/8T X 1/8P 90*</p>	<p>641-104 2</p>  <p>5/32T UNION</p>	<p>641-120 2</p>  <p>5/32T X 1/8P</p>



**CANTON FLEET - INDUSTRIAL SUPPLY**  
**COLUMBUS FLEET - INDUSTRIAL SUPPLY**

WWW.cfisgroup.com

(614) 332-7464

PART # 0641-27

# ASSORTMENT: PUSH-TO CONNECT

01/22

641-244 2



1/2T X 1/4P

641-296



1/2 UNION TEE

641-233 2



3/8T X 1/8P

641-294



3/8 UNION TEE

641-222 2



1/4T X 1/16P

641-292



1/4 UNION TEE

PART # 0641-30

**ASSORTMENT: PUSH-TO CONNECT**

01/22

<p>641-210 1</p>  <p>5/8T UNION</p>	<p>641-249 1</p>  <p>5/8T X 3/8P</p>	<p>641-250 1</p>  <p>5/8T X 1/2P</p>	<p>641-289 1</p>  <p>5/8T X 1/2P</p>	<p>641-356 1</p>  <p>1/2T X 3/8P 45*</p>	<p>641-358 1</p>  <p>1/2T X 1/2P 45*</p>
<p>641-208 1</p>  <p>1/2T UNION</p>	<p>641-244 1</p>  <p>1/2T X 1/4P</p>	<p>641-246 1</p>  <p>1/2T X 3/8P</p>	<p>641-248 1</p>  <p>1/2T X 1/2P</p>	<p>641-286 1</p>  <p>1/2T X 3/8P 90*</p>	<p>641-287 1</p>  <p>1/2T X 1/2P 90*</p>
<p>641-206 2</p>  <p>3/8T UNION</p>	<p>641-234 2</p>  <p>3/8T X 1/4P</p>	<p>641-236 2</p>  <p>3/8T X 3/8P</p>	<p>641-274 1</p>  <p>3/8T X 1/4P 90*</p>	<p>641-276 1</p>  <p>3/8T X 3/8P 90*</p>	<p>641-351 1</p>  <p>3/8T X 3/8P 45*</p>
<p>641-204 2</p>  <p>1/4T UNION</p>	<p>641-224 2</p>  <p>1/4T X 1/8P</p>	<p>641-228 2</p>  <p>1/4T X 1/4P</p>	<p>641-262 2</p>  <p>1/4T X 1/8P 90*</p>	<p>641-264 2</p>  <p>1/4T X 1/4P 90*</p>	<p>641-345 1</p>  <p>1/4T X 1/4P 45*</p>

**PART # 0641-40**

# ASSORTMENT: PUSH TO CONNECT

01/22

**641-292**

**1**



**1/4 UNION TEE**

**641-294**

**1**



**3/8 UNION TEE**

**641-296**

**1**



**1/2 UNION TEE**

**641-289**

**2**



**5/8 TUBE TO 1/2 PIPE**

**641-210**

**2**



**5/8 UNION**

**641-249**

**2**



**5/8 TUBE TO 3/8 PIPE**

**641-250**

**2**



**5/8 TUBE TO 1/2 PIPE**

**641-288**

**2**



**5/8 TUBE TO 3/8 PIPE**

PART # 0641-50

**ASSORTMENT: PUSH-TO CONNECT**

01/22

<p>641-132 1</p>  <p>1/8T X 1/8P 90*</p>	<p>641-138 1</p>  <p>5/32T X 1/16P 90*</p>	<p>641-130 1</p>  <p>3/16T X 1/4P</p>	<p>641-143 1</p>  <p>3/16T X 1/8P 90*</p>	<p>641-294 1</p>  <p>3/8 UNION TEE</p>	<p>641-210 1</p>  <p>5/8T UNION</p>
<p>641-116 1</p>  <p>1/8T X 1/8P</p>	<p>641-120 1</p>  <p>5/32T X 1/8P</p>	<p>641-129 1</p>  <p>3/16T X 1/8P</p>	<p>641-142 1</p>  <p>3/16T X 1/16P 90*</p>	<p>641-292 1</p>  <p>1/4 UNION TEE</p>	<p>641-208 1</p>  <p>1/2T UNION</p>
<p>641-112 1</p>  <p>1/8T X 1/16P</p>	<p>641-119 1</p>  <p>5/32T X 1/16P</p>	<p>641-128 1</p>  <p>3/16T X 1/16P</p>	<p>641-141 1</p>  <p>5/32T X 1/4P 90*</p>	<p>641-156 1</p>  <p>5/32 UNION TEE</p>	<p>641-206 2</p>  <p>3/8T UNION</p>
<p>641-102 2</p>  <p>1/8T UNION</p>	<p>641-106 2</p>  <p>5/32T UNION</p>	<p>641-108 2</p>  <p>3/16T UNION</p>	<p>641-140 1</p>  <p>5/32T X 1/8P 90*</p>	<p>641-152 1</p>  <p>1/8 UNION TEE</p>	<p>641-204 2</p>  <p>1/4T UNION</p>

PART # 0641-52

**ASSORTMENT: PUSH-TO CONNECT**

01/22

<p>641-249 1</p>  <p>5/8T X 3/8P</p>	<p>641-250 1</p>  <p>5/8T X 1/2P</p>	<p>641-288 1</p>  <p>5/8T X 3/8P 90*</p>	<p>641-289 1</p>  <p>5/8T X 1/2P 90*</p>		
<p>641-244 1</p>  <p>1/2T X 1/4P</p>	<p>641-246 1</p>  <p>1/2T X 3/8P</p>	<p>641-248 1</p>  <p>1/2T X 1/2P</p>	<p>641-285 1</p>  <p>1/2T X 1/4P 90*</p>	<p>641-286 1</p>  <p>1/2T X 3/8P 90*</p>	<p>641-287 1</p>  <p>1/2T X 1/2P 90*</p>
<p>641-233 1</p>  <p>3/8T X 1/8P</p>	<p>641-234 1</p>  <p>3/8T X 1/4P</p>	<p>641-236 1</p>  <p>3/8T X 3/8P</p>	<p>641-273 1</p>  <p>3/8T X 1/8P 90*</p>	<p>641-274 1</p>  <p>3/8T X 1/4P 90*</p>	<p>641-276 1</p>  <p>3/8T X 3/8P 90*</p>
<p>641-222 1</p>  <p>1/4T X 1/16P</p>	<p>641-224 1</p>  <p>1/4T X 1/8P</p>	<p>641-228 1</p>  <p>1/4T X 1/4P</p>	<p>641-262 1</p>  <p>1/4T X 1/8P 90*</p>	<p>641-264 1</p>  <p>1/4T X 1/4P 90*</p>	<p>641-296 1</p>  <p>1/2 UNION TEE</p>

PART # 0641-54

**ASSORTMENT: PUSH-TO CONNECT**

01/22

<p>641-364 1</p>  <p>5/8T X 3/8P</p>	<p>641-365 1</p>  <p>5/8T X 1/2P</p>	<p>641-304 1</p>  <p>3/8T X 1/4P</p>	<p>641-306 1</p>  <p>3/8T X 3/8P</p>	<p>641-308 1</p>  <p>1/2T X 3/8P</p>	<p>641-309 1</p>  <p>1/2T X 1/2P</p>
<p>641-355 1</p>  <p>1/2T X 1/4P</p>	<p>641-356 1</p>  <p>1/2T X 3/8P</p>	<p>641-358 1</p>  <p>1/2T X 1/2P</p>	<p>641-328 1</p>  <p>1/2T X 3/8P</p>	<p>641-329 1</p>  <p>1/2T X 1/2P</p>	
<p>641-349 1</p>  <p>3/8T X 1/8P</p>	<p>641-350 1</p>  <p>3/8T X 1/4P</p>	<p>641-351 1</p>  <p>3/8T X 3/8P</p>	<p>641-325A 1</p>  <p>3/8T X 1/8P</p>	<p>641-325 1</p>  <p>3/8T X 1/4P</p>	<p>641-326 1</p>  <p>3/8T X 3/8P</p>
<p>641-344 1</p>  <p>1/4T X 1/8P</p>	<p>641-345 1</p>  <p>1/4T X 1/4P</p>	<p>641-300 1</p>  <p>1/4T X 1/8P</p>	<p>641-302 1</p>  <p>1/4T X 1/4P</p>	<p>641-322 1</p>  <p>1/4T X 1/8P</p>	<p>641-323 1</p>  <p>1/4T X 1/4P</p>

**PART # 0655-25**

# ASSORTMENT: AIR BRAKE

01/22

**655-841**

**2**

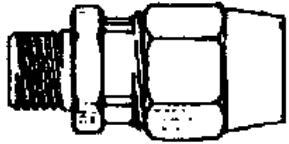

**3/8 HOSE TO 1/4 PIPE**

**655-842**

**2**

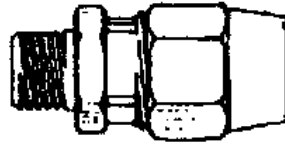

**3/8 HOSE TO 3/8 PIPE**

**655-843**

**1**



**3/8 HOSE TO 1/2 PIPE**

**655-820**

**5**



**GLAD HAND SEALS**

**655-875**

**2**

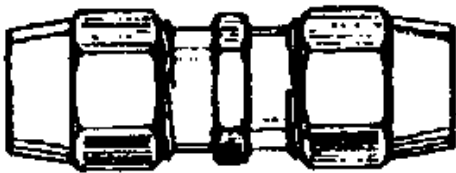

**3/8 HOSE UNION**

**655-802**

**2**



**3/8 PIPE REPAIR KIT**

**655-803**

**1**



**1/2 PIPE REPAIR KIT**

**655-830**

**5**



**3/8 NUT**

**655-839**

**5**



**3/8 SLEEVE**

**PART # 0655-35**

# ASSORTMENT: AIR BRAKE

01/22

**655-839**

**5**



**3/8 SLEEVE**

**655-843**

**2**



**3/8 HOSE TO 1/2 PIPE**

**655-912**

**2**



**3/8 HOSE TO 1/4 PIPE**

**655-916**

**2**



**3/8 HOSE TO 1/2 PIPE**

**655-830**

**2**



**3/8 NUT**

**655-842**

**2**



**3/8 HOSE TO 3/8 PIPE**

**655-875**

**2**



**3/8 HOSE MENDERS**

**655-914**

**2**



**3/8 HOSE TO 3/8 PIPE**

**655-820**

**5**



**GLAD HAND SEALS**

**655-841**

**2**



**3/8 HOSE TO 1/4 PIPE**

**PART # 0655-40**

# ASSORTMENT: AIR BRAKE

01/22

**655-878**      2



**1/2 HOSE MENDERS**

**655-831**      2



**1/2 NUT**

**655-840**      5



**1/2 SLEEVE**

**655-855**      2

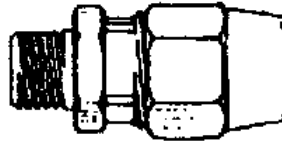

**1/2 HOSE TO 1/2 PIPE**

**655-854**      2



**1/2 HOSE TO 3/8 PIPE**

**655-920**      2



**1/2 HOSE TO 1/2 PIPE**

**655-918**      2



**1/2 HOSE TO 3/8 PIPE**

**655-954**      2

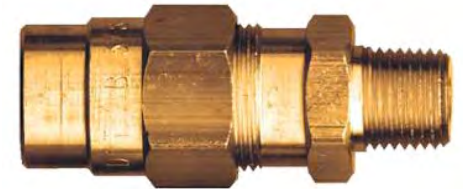

**3/8 HOSE TO 1/2 SWIVEL**





















**655-952**      2



**3/8 HOSE TO 3/8 SWIVEL**





















**PART # 0681-10 ASSORTMENT: SAE 45\* / JIC 37\* PLUGS / CAPS**

01/22

<p><b>A-2408-06</b></p> <p>1</p>  <p><b>3/8T PLUG (JIC)</b></p>	<p><b>A-304C-06</b></p> <p>1</p>  <p><b>3/8T CAP (JIC)</b></p>	<p><b>A-2408-12</b></p> <p>1</p>  <p><b>3/4T PLUG (JIC)</b></p>	<p><b>A-304C-12</b></p> <p>1</p>  <p><b>3/4T CAP (JIC)</b></p>		<p><b>A-304C-16</b></p> <p>1</p>  <p><b>1" T</b></p>
<p><b>681-012</b></p> <p>1</p>  <p><b>3/4T PLUG</b></p>	<p><b>681-032</b></p> <p>1</p>  <p><b>3/4T CAP</b></p>				<p><b>A-2408-16</b></p> <p>1</p>  <p><b>1" T</b></p>
<p><b>681-024</b></p> <p>2</p>  <p><b>1/4T CAP</b></p>	<p><b>681-025</b></p> <p>2</p>  <p><b>5/16T CAP</b></p>	<p><b>681-026</b></p> <p>2</p>  <p><b>3/8T CAP</b></p>	<p><b>681-028</b></p> <p>2</p>  <p><b>1/2T CAP</b></p>	<p><b>681-030</b></p> <p>1</p>  <p><b>5/8T CAP</b></p>	<p><b>A-304C-14</b></p> <p>1</p>  <p><b>7/8" T</b></p>
<p><b>681-004</b></p> <p>2</p>  <p><b>1/4T PLUG</b></p>	<p><b>681-005</b></p> <p>2</p>  <p><b>5/16T PLUG</b></p>	<p><b>681-006</b></p> <p>2</p>  <p><b>3/8T PLUG</b></p>	<p><b>681-008</b></p> <p>2</p>  <p><b>1/2T PLUG</b></p>	<p><b>681-010</b></p> <p>1</p>  <p><b>5/8T PLUG</b></p>	<p><b>A-2408-14</b></p> <p>1</p>  <p><b>7/8" T</b></p>

**PART # 0681-12 ASSORTMENT: SAE 45\* / JIC 37\* PLUGS / CAPS**





















01/22

<p>681-032 1</p>  <p>3/4T CAP</p>	<p>A-304C-14 1</p>  <p>7/8\"T</p>	<p>A-304C-16 1</p>  <p>1\"T</p>	<p>A-304C-08 1</p>  <p>3/8T CAP (JIC)</p>	<p>A-304C-12 1</p>  <p>3/4T CAP (JIC)</p>
<p>681-024 2</p>  <p>1/4T CAP</p>	<p>681-025 2</p>  <p>5/16T CAP</p>	<p>681-026 2</p>  <p>3/8T CAP</p>	<p>681-028 2</p>  <p>1/2T CAP</p>	<p>681-030 1</p>  <p>5/8T CAP</p>
<p>681-012 1</p>  <p>3/4T PLUG</p>	<p>A-2408-14 1</p>  <p>7/8\"T</p>	<p>A-2408-16 1</p>  <p>1\"T</p>	<p>A-2408-06 1</p>  <p>3/8T PLUG (JIC)</p>	<p>A-2408-12 1</p>  <p>3/4T PLUG (JIC)</p>
<p>681-004 2</p>  <p>1/4T PLUG</p>	<p>681-005 2</p>  <p>5/16T PLUG</p>	<p>681-006 2</p>  <p>3/8T PLUG</p>	<p>681-008 2</p>  <p>1/2T PLUG</p>	<p>681-010 1</p>  <p>5/8T PLUG</p>

PART # 0681-20

**ASSORTMENT: JIC 37\* PLUGS / CAPS**

01/22

<p>A-304C-04 2</p>  <p>1/4 JIC 37* CAP</p>	<p>A-304C-05 2</p>  <p>5/16 JIC 37* CAP</p>	<p>A-304C-06 2</p>  <p>3/8 JIC 37* CAP</p>	<p>A-304C-08 2</p>  <p>1/2 JIC 37* CAP</p>	<p>A-304C-10 2</p>  <p>5/8 JIC 37* CAP</p>
<p>A-304C-12 2</p>  <p>3/4 JIC 37* CAP</p>	<p>A-304C-14 2</p>  <p>7/8 JIC 37* CAP</p>	<p>A-304C-16 2</p>  <p>1" JIC 37* CAP</p>	<p>681-026 2</p>  <p>3/8 JIC SAE 45* CAP</p>	<p>681-032 2</p>  <p>3/4 JIC SAE 45* CAP</p>
<p>A-2408-04 2</p>  <p>1/4 JIC 37* PLUG</p>	<p>A-2408-05 2</p>  <p>5/16 JIC 37* PLUG</p>	<p>A-2408-06 2</p>  <p>3/8 JIC 37* PLUG</p>	<p>A-2408-08 2</p>  <p>1/2 JIC 37* PLUG</p>	<p>A-2408-10 2</p>  <p>5/8 JIC 37* PLUG</p>
<p>A-2408-12 2</p>  <p>3/4 JIC 37* PLUG</p>	<p>A-2408-14 2</p>  <p>7/8 JIC 37* PLUG</p>	<p>A-2408-16 2</p>  <p>1" JIC 37* PLUG</p>	<p>681-006 2</p>  <p>3/8 JIC SAE 45* PLUG</p>	<p>681-012 2</p>  <p>3/4 JIC SAE 45* PLUG</p>

PART # 0681-25

**ASSORTMENT: SAE 45\* BRASS**























01/22

<p>681-126 2</p>  <p>1/4T X 1/8P</p>	<p>681-127 2</p>  <p>1/4T X 1/4P</p>	<p>681-132 2</p>  <p>5/16T X 1/4P</p>	<p>681-136 2</p>  <p>3/8T X 1/4P</p>	<p>681-137 1</p>  <p>3/8T X 3/8P</p>	<p>681-142 1</p>  <p>1/2T X 3/8P</p>
<p>681-104 2</p>  <p>1/4T UNION</p>	<p>681-105 2</p>  <p>5/16T UNION</p>	<p>681-106 2</p>  <p>3/8T UNION</p>	<p>681-108 2</p>  <p>1/2T UNION</p>	<p>681-110 1</p>  <p>5/8T UNION</p>	<p>681-143 1</p>  <p>1/2T X 1/2P</p>
<p>681-024 2</p>  <p>1/4T CAP</p>	<p>681-025 2</p>  <p>5/16T CAP</p>	<p>681-026 2</p>  <p>3/8T CAP</p>	<p>681-028 2</p>  <p>1/2T CAP</p>	<p>681-030 1</p>  <p>5/8T CAP</p>	<p>681-147 1</p>  <p>5/8T X 3/8P</p>
<p>681-004 2</p>  <p>1/4T PLUG</p>	<p>681-005 2</p>  <p>5/16T PLUG</p>	<p>681-006 2</p>  <p>3/8T PLUG</p>	<p>681-008 2</p>  <p>1/2T PLUG</p>	<p>681-010 1</p>  <p>5/8T PLUG</p>	<p>681-148 1</p>  <p>5/8T X 1/2P</p>

PART # 0681-28

**ASSORTMENT: SAE 45\* BRASS**

























01/22

<p>681-207 1</p>  <p>1/4T X 1/4P</p>	<p>681-217 1</p>  <p>3/8T X 3/8P</p>	<p>681-223 1</p>  <p>1/2T X 1/2P</p>	<p>681-228 1</p>  <p>5/8T X 1/2P</p>		<p>681-188 1</p>  <p>5/8T X 1/2P</p>
<p>681-142 1</p>  <p>1/2T X 3/8P</p>	<p>681-143 1</p>  <p>1/2T X 1/2P</p>	<p>681-147 1</p>  <p>5/8T X 3/8P</p>	<p>681-148 1</p>  <p>5/8T X 1/2P</p>	<p>681-151 1</p>  <p>3/4T X 1/2P</p>	<p>681-183 1</p>  <p>1/2T X 1/2P</p>
<p>681-126 1</p>  <p>1/4T X 1/8P</p>	<p>681-127 1</p>  <p>1/4T X 1/4P</p>	<p>681-132 1</p>  <p>5/16T X 1/4P</p>	<p>681-136 1</p>  <p>3/8T X 1/4P</p>	<p>681-137 1</p>  <p>3/8T X 3/8P</p>	<p>681-177 1</p>  <p>3/8T X 3/8P</p>
<p>681-104 1</p>  <p>1/4T UNION</p>	<p>681-105 1</p>  <p>5/16T UNION</p>	<p>681-106 1</p>  <p>3/8T UNION</p>	<p>681-108 1</p>  <p>1/2T UNION</p>	<p>681-110 1</p>  <p>5/8T UNION</p>	<p>681-167 1</p>  <p>1/4T X 1/4P</p>

PART # 0691-30

**ASSORTMENT: JIC 37\* ADAPTERS**





















01/22

<p>A-2408-04 1</p>  <p>1/4T</p>	<p>A-304C-04 1</p>  <p>1/4T</p>	<p>A-2403-04 1</p>  <p>1/4T</p>	<p>681-006 2</p>  <p>3/8T PLUG</p>	<p>681-026 2</p>  <p>3/8T CAP</p>	<p>681-012 1</p>  <p>3/4T PLUG</p>	<p>681-032 1</p>  <p>3/4T CAP</p>
<p>A-2403-05-05 2</p>  <p>5/16T</p>	<p>A-2403-06-06 2</p>  <p>3/8T</p>	<p>A-2403-08-08 2</p>  <p>1/2T</p>	<p>A-2403-10-10 1</p>  <p>5/8T</p>	<p>A-2403-12-12 1</p>  <p>3/4T</p>	<p>A-2403-16-16 1</p>  <p>1" T</p>	
<p>A-304C-05 2</p>  <p>5/16T</p>	<p>A-304C-06 2</p>  <p>3/8T</p>	<p>A-304C-08 2</p>  <p>1/2T</p>	<p>A-304C-10 1</p>  <p>5/8T</p>	<p>A-304C-12 1</p>  <p>3/4T</p>	<p>A-304C-16 1</p>  <p>1" T</p>	
<p>A-2408-05 2</p>  <p>5/16T</p>	<p>A-2408-06 2</p>  <p>3/8T</p>	<p>A-2408-08 2</p>  <p>1/2T</p>	<p>A-2408-10 1</p>  <p>5/8T</p>	<p>A-2408-12 1</p>  <p>3/4T</p>	<p>A-2408-16 1</p>  <p>1" T</p>	

PART # 0691-33

**ASSORTMENT: JIC 37\* ADAPTERS**

01/22

<p>A-2408-12-12 1</p>  <p>3/4T</p>	<p>A-304C-14-14 1</p>  <p>7/8T</p>				<p>A-304C-14 1</p>  <p>7/8T</p>
<p>A-2403-04-04 2</p>  <p>1/4T</p>	<p>A-2403-05-05 2</p>  <p>5/16T</p>	<p>A-2403-06-06 2</p>  <p>3/8T</p>	<p>A-2403-08-08 1</p>  <p>1/2T</p>	<p>A-2403-10-10 1</p>  <p>5/8T</p>	<p>A-2408-14 1</p>  <p>7/8T</p>
<p>A-304C-04 2</p>  <p>1/4T</p>	<p>A-304C-05 2</p>  <p>5/16T</p>	<p>A-304C-06 2</p>  <p>3/8T</p>	<p>A-304C-08 1</p>  <p>1/2T</p>	<p>A-304C-10 1</p>  <p>5/8T</p>	<p>A-304C-12 1</p>  <p>3/4T</p>
<p>A-2408-04 2</p>  <p>1/4T</p>	<p>A-2408-05 2</p>  <p>5/16T</p>	<p>A-2408-06 2</p>  <p>3/8T</p>	<p>A-2408-08 1</p>  <p>1/2T</p>	<p>A-2808-10 1</p>  <p>5/8T</p>	<p>A-2408-12 1</p>  <p>3/4T</p>



**CANTON FLEET - INDUSTRIAL SUPPLY**  
**COLUMBUS FLEET - INDUSTRIAL SUPPLY**







WWW.cfisgroup.com

(614) 332-7464

PART # 0691-34

# ASSORTMENT: JIC 37\* ADAPTERS





















01/22

					<b>A-2408-14-14</b> 1  7/8T
<b>A-2403-04-04</b> 2  1/4T	<b>A-2403-05-05</b> 2  5/16T	<b>A-2403-06-06</b> 2  3/8T	<b>A-2403-08-08</b> 1  1/2T	<b>A-2403-10-10</b> 1  5/8T	<b>A-2408-12-12</b> 1  3/4T

PART # 0691-35

# ASSORTMENT: JIC 37\* ADAPTERS

01/22

<p><b>A-2408-04</b> 2</p>  <p>1/4T</p>	<p><b>A-2408-06</b> 2</p>  <p>3/8T</p>	<p><b>A-2408-08</b> 2</p>  <p>1/2T</p>	<p><b>A-304C-04</b> 1</p>  <p>1/4T</p>	<p><b>A-304C-06</b> 1</p>  <p>3/8T</p>	<p><b>A-304C-08</b> 1</p>  <p>1/2T</p>
<p><b>A-2403-08-08</b> 2</p>  <p>1/2T</p>		<p><b>A-2404-08-06</b> 2</p>  <p>1/2T - 3/8P</p>	<p><b>A-2404-08-08</b> 1</p>  <p>1/2T - 1/2P</p>	<p><b>A-2501-08-06</b> 1</p>  <p>1/2T - 3/8P</p>	<p><b>A-2501-08-08</b> 1</p>  <p>1/2T - 1/2P</p>
<p><b>A-2403-06-06</b> 2</p>  <p>3/8T</p>		<p><b>A-2404-06-04</b> 2</p>  <p>3/8T - 1/4P</p>	<p><b>A-2404-06-06</b> 1</p>  <p>3/8T - 3/8P</p>	<p><b>A-2501-06-04</b> 1</p>  <p>3/8T - 1/4P</p>	<p><b>A-2501-06-06</b> 1</p>  <p>3/8T - 3/8P</p>
<p><b>A-2403-04-04</b> 2</p>  <p>1/4T</p>		<p><b>A-2404-04-02</b> 2</p>  <p>1/4T - 1/8P</p>	<p><b>A-2404-04-04</b> 1</p>  <p>1/4T - 1/4P</p>	<p><b>A-2501-04-04</b> 1</p>  <p>1/4T - 1/4P</p>	

PART # 0691-40

















# ASSORTMENT: JIC 37\* ADAPTERS

01/22

PART # 0691-44

# ASSORTMENT: JIC 37\* ADAPTERS

















01/22

	<p>A-2404-10-06 1</p>  <p>5/8T - 3/8P</p>		<p>A-2404-16-12 1</p>  <p>1"T - 3/4P</p>	<p>A-2404-16-16 1</p>  <p>1"T - 1"P</p>
<p>A-2404-08-08 1</p>  <p>1/2T - 1/2P</p>	<p>A-2404-10-08 1</p>  <p>5/8T - 1/2P</p>		<p>A-2404-12-08 1</p>  <p>3/4T - 1/2P</p>	<p>A-2404-12-12 1</p>  <p>3/4T - 3/4P</p>
<p>A-2404-06-04 2</p>  <p>3/8T - 1/4P</p>	<p>A-2404-06-06 2</p>  <p>3/8T - 3/8P</p>	<p>A-2404-06-08 1</p>  <p>3/8T - 1/2P</p>	<p>A-2404-08-04 1</p>  <p>1/2T - 1/4P</p>	<p>A-2404-08-06 1</p>  <p>1/2T - 3/8P</p>
<p>A-2404-04-02 2</p>  <p>1/4T - 1/8P</p>	<p>A-2404-04-04 2</p>  <p>1/4T - 1/4P</p>	<p>A-2404-04-06 2</p>  <p>1/4T - 3/8P</p>	<p>A-2404-05-02 2</p>  <p>5/16T - 1/8P</p>	<p>A-2404-05-04 2</p>  <p>5/16T - 1/4P</p>

PART # 0691-48

# ASSORTMENT: JIC 37\* ADAPTERS











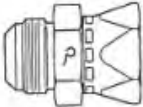
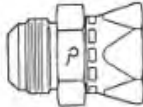

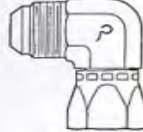

01/22

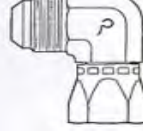
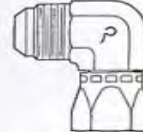
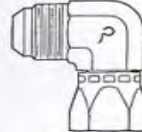
	<p>A-2501-10-06 1</p>  <p>5/8T - 3/8P</p>		<p>A-2501-16-12 1</p>  <p>1" T - 3/4P</p>	<p>A-2501-16-16 1</p>  <p>1" T - 1" P</p>
<p>A-2501-08-08 1</p>  <p>1/2T - 1/2P</p>	<p>A-2501-10-08 1</p>  <p>5/8T - 1/2P</p>		<p>A-2501-12-08 1</p>  <p>3/4T - 1/2P</p>	<p>A-2501-12-12 1</p>  <p>3/4T - 3/4P</p>
<p>A-2501-06-04 2</p>  <p>3/8T - 1/4P</p>	<p>A-2501-06-06 2</p>  <p>3/8T - 3/8P</p>	<p>A-2501-06-08 1</p>  <p>3/8T - 1/2P</p>	<p>A-2501-08-04 1</p>  <p>1/2T - 1/4P</p>	<p>A-2501-08-06 1</p>  <p>1/2T - 3/8P</p>
<p>A-2501-04-02 2</p>  <p>1/4T - 1/8P</p>	<p>A-2501-04-04 2</p>  <p>1/4T - 1/4P</p>	<p>A-2501-04-06 2</p>  <p>1/4T - 3/8P</p>	<p>A-2501-05-02 2</p>  <p>5/16T - 1/8P</p>	<p>A-2501-05-04 2</p>  <p>5/16T - 1/4P</p>

PART # 0691-50

**ASSORTMENT: JIC 37\* ADAPTERS**

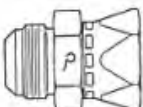
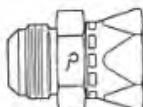
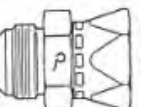
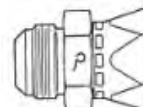
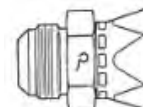









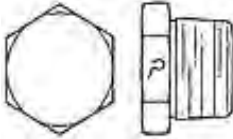
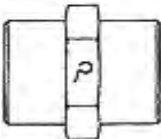
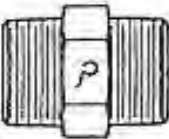
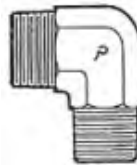

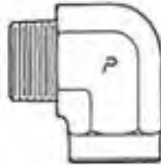
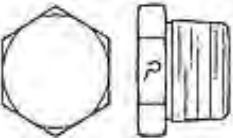
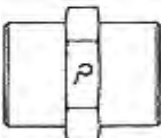

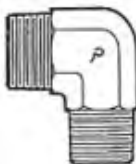
01/22

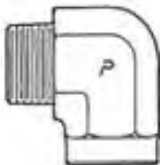
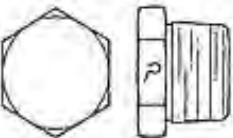
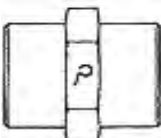
<p><b>A-6504-04-04</b> 1</p>  <p>1/4T - 1/4T</p>	<p><b>A-6504-05-05</b> 1</p>  <p>5/16T - 5/16T</p>	<p><b>A-6502-04-04</b> 1</p>  <p>1/4T - 1/4T</p>	<p><b>A-6502-05-05</b> 1</p>  <p>5/16T - 5/16T</p>	<p><b>A-6500-04-04</b> 1</p>  <p>1/4T - 1/4T</p>	<p><b>A-6500-05-05</b> 1</p>  <p>5/16T - 5/16T</p>
<p><b>A-6500-06-06</b> 1</p>  <p>3/8T - 3/8T</p>	<p><b>A-6500-08-08</b> 1</p>  <p>1/2T - 1/2T</p>	<p><b>A-6500-10-10</b> 1</p>  <p>5/8T - 5/8T</p>	<p><b>A-6500-12-12</b> 1</p>  <p>3/4T - 3/4T</p>	<p><b>A-6500-14-14</b> 1</p>  <p>7/8T - 7/8T</p>	<p><b>A-6500-16-16</b> 1</p>  <p>1" T - 1" P</p>
<p><b>A-6502-06-06</b> 1</p>  <p>3/8T - 3/8T</p>	<p><b>A-6502-08-08</b> 1</p>  <p>1/2T - 1/2T</p>	<p><b>A-6502-10-10</b> 1</p>  <p>5/8T - 5/8T</p>	<p><b>A-6502-12-12</b> 1</p>  <p>3/4T - 3/4T</p>	<p><b>A-6502-14-14</b> 1</p>  <p>7/8T - 7/8T</p>	<p><b>A-6502-16-16</b> 1</p>  <p>1" T - 1" P</p>
<p><b>A-6504-06-06</b> 1</p>  <p>3/8T - 3/8T</p>	<p><b>A-6504-08-08</b> 1</p>  <p>1/2T - 1/2T</p>	<p><b>A-6504-10-10</b> 1</p>  <p>5/8T - 5/8T</p>	<p><b>A-6504-12-12</b> 1</p>  <p>3/4T - 3/4T</p>	<p><b>A-6504-14-14</b> 1</p>  <p>7/8T - 7/8T</p>	<p><b>A-6504-16-16</b> 1</p>  <p>1" T - 1" P</p>

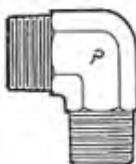
PART # 0691-85

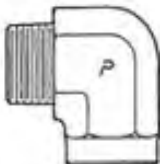
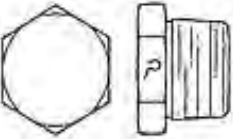
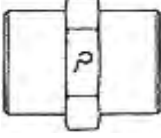
**ASSORTMENT: STEEL PIPE ADAPTERS**

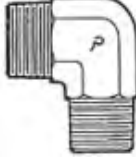

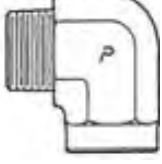







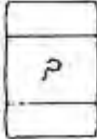

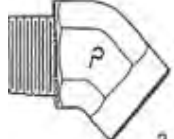
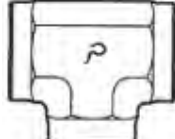
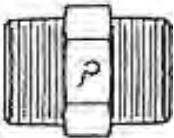

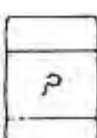

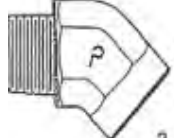
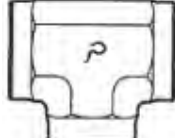
01/22

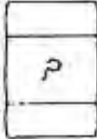
<p><b>A-5406P-08</b> 1</p>  <p><b>1/2P PLUG</b></p>	<p><b>A-5000-08-08</b> 1</p>  <p><b>1/2P COUPLER</b></p>	<p><b>A-5404-08-08</b> 1</p>  <p><b>1/2P NIPPLE</b></p>	<p><b>A-5500-08-08</b> 1</p>  <p><b>1/2P 90* MALE</b></p>	<p><b>A-5504-08-08-4</b> 1</p>  <p><b>1/2P 90 ELBOW</b></p>	<p><b>A-5502-08-08-4</b> 1</p>  <p><b>1/2P 90* ST ELBOW</b></p>
<p><b>A-5406P-06</b> 1</p>  <p><b>3/8P PLUG</b></p>	<p><b>A-5000-06-06</b> 1</p>  <p><b>3/8P COUPLER</b></p>	<p><b>A-5404-06-06</b> 1</p>  <p><b>3/8P NIPPLE</b></p>	<p><b>A-5500-06-06</b> 1</p>  <p><b>3/8P 90* MALE</b></p>	<p><b>A-5504-06-06-4</b> 1</p>  <p><b>3/8P 90 ELBOW</b></p>	<p><b>A-5502-06-06-4</b> 1</p>  <p><b>3/8P 90* ST ELBOW</b></p>
<p><b>A-5406P-04</b> 1</p>  <p><b>1/4P PLUG</b></p>	<p><b>A-5000-04-04</b> 1</p>  <p><b>1/4P COUPLER</b></p>	<p><b>A-5404-04-04</b> 1</p>  <p><b>1/4P NIPPLE</b></p>	<p><b>A-5500-04-04</b> 1</p>  <p><b>1/4P 90* MALE</b></p>	<p><b>A-5504-04-04-4</b> 1</p>  <p><b>1/4P 90 ELBOW</b></p>	<p><b>A-5502-04-04-4</b> 1</p>  <p><b>1/4P 90* ST ELBOW</b></p>
<p><b>A-5406P-02</b> 1</p>  <p><b>1/8P PLUG</b></p>	<p><b>A-5000-02-02</b> 1</p>  <p><b>1/8P COUPLER</b></p>	<p><b>A-5404-02-02</b> 1</p>  <p><b>1/8P NIPPLE</b></p>	<p><b>A-5500-02-02</b> 1</p>  <p><b>1/8P 90* MALE</b></p>	<p><b>A-5504-02-02-4</b> 1</p>  <p><b>1/8P 90 ELBOW</b></p>	<p><b>A-5502-02-02-4</b> 1</p>  <p><b>1/8P 90* ST ELBOW</b></p>

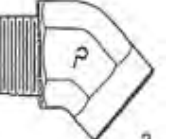
PART # 0691-89

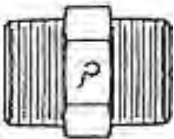
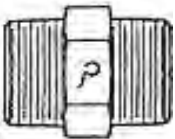
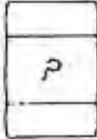
**ASSORTMENT: STEEL PIPE ADAPTERS**

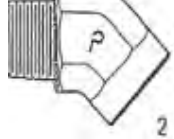





01/22

<p><b>A-5404-08-06</b> 1</p>  <p><b>3/8P X 1/2P</b></p>		<p><b>A-5406C-08</b> 1</p>  <p><b>1/2P CAP</b></p>	<p><b>A-5505-08-08-08-4</b> 1</p>  <p><b>1/2P 45* ELBOW</b></p>	<p><b>A-5503-08-08-4</b> 1</p>  <p><b>1/2P 45* ELBOW</b></p>	<p><b>A-5605-08-08-08-4</b> 1</p>  <p><b>1/2P TEE</b></p>
<p><b>A-5404-08-04</b> 1</p>  <p><b>1/4P X 1/2P</b></p>	<p><b>A-5404-16-16</b> 1</p>  <p><b>1" X 1"</b></p>	<p><b>A-5406C-06</b> 1</p>  <p><b>3/8P CAP</b></p>	<p><b>A-5505-06-06-06-4</b> 1</p>  <p><b>3/8P 45* ELBOW</b></p>	<p><b>A-5503-06-06-4</b> 1</p>  <p><b>3/8P 45* ELBOW</b></p>	<p><b>A-5605-06-06-06-4</b> 1</p>  <p><b>3/8P TEE</b></p>
<p><b>A-5404-06-04</b> 1</p>  <p><b>1/4P X 3/8P</b></p>	<p><b>A-5404-12-12</b> 1</p>  <p><b>3/4 X 3/4</b></p>	<p><b>A-5406C-04</b> 1</p>  <p><b>1/4P CAP</b></p>	<p><b>A-5505-04-04-04-4</b> 1</p>  <p><b>1/4P 45* ELBOW</b></p>	<p><b>A-5503-04-04-4</b> 1</p>  <p><b>1/4P 45* ELBOW</b></p>	<p><b>A-5605-04-04-04-4</b> 1</p>  <p><b>1/4P TEE</b></p>
<p><b>A-5404-04-04</b> 1</p>  <p><b>1/8P X 1/4P</b></p>	<p><b>A-5404-12-08</b> 1</p>  <p><b>1/2 X 3/4</b></p>	<p><b>A-5406C-02</b> 1</p>  <p><b>1/8P CAP</b></p>	<p><b>A-5505-02-02-02-4</b> 1</p>  <p><b>1/8P 45* ELBOW</b></p>	<p><b>A-5503-02-02-4</b> 1</p>  <p><b>1/8P 45* ELBOW</b></p>	<p><b>A-5605-02-02-02-4</b> 1</p>  <p><b>1/8P TEE</b></p>

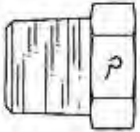
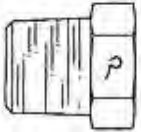
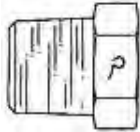
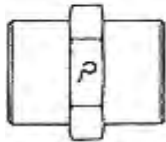
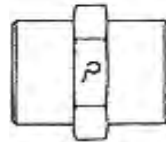
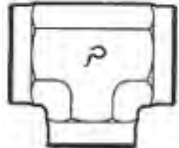
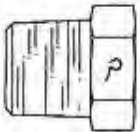
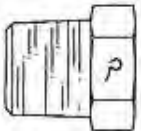
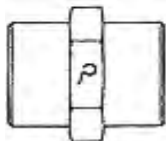
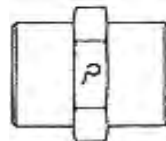
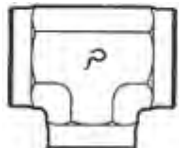
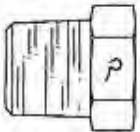
PART # 0691-92

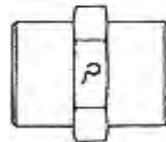
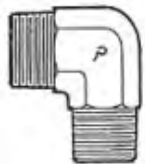
**ASSORTMENT: STEEL PIPE ADAPTERS**

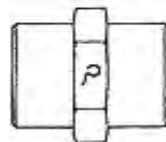
01/22

<p>A-5406-08-04 1</p>  <p>1/2P X 1/4P BUSH</p>	<p>A-5406-16-08 1</p>  <p>1P X 1/2P BUSH</p>	<p>A-5406-16-08 1</p>  <p>1P X 1/2P BUSH</p>	<p>A-5500-12-08-4 1</p>  <p>3/4P X 1/2P COUP</p>	<p>A-5500-08-06-4 1</p>  <p>3/8P X 1/2P COUP</p>	<p>A-5605-16-16-16-4 1</p>  <p>1P TEE</p>
<p>A-5406-06-04 1</p>  <p>3/8P X 1/4P BUSH</p>	<p>A-5406-12-08 1</p>  <p>3/4P X 1/2P BUSH</p>		<p>A-5500-12-06-4 1</p>  <p>3/4P X 3/8P COUP</p>	<p>A-5500-06-04-4 1</p>  <p>1/4P X 3/8 COUP</p>	<p>A-5605-12-12-12-4 1</p>  <p>3/4P TEE</p>
<p>A-5406-06-02 1</p>  <p>3/8P X 1/8P BUSH</p>	<p>A-5406-12-06 1</p>  <p>3/4P X 3/8P BUSH</p>			<p>A-5500-04-04-4 1</p>  <p>1P COUPLER</p>	<p>A-5500-16-16-4 1</p>  <p>1P 90 MALE</p>
<p>A-5406-04-02 1</p>  <p>1/8P X 1/4P BUSH</p>	<p>A-5406-08-06 1</p>  <p>1/2P X 3/8P BUSH</p>			<p>A-5500-02-02-4 1</p>  <p>3/4P COUPLER</p>	<p>A-5500-012-12-4 1</p>  <p>3/4P 90 MALE</p>



**CANTON FLEET - INDUSTRIAL SUPPLY**  
**COLUMBUS FLEET - INDUSTRIAL SUPPLY**

WWW.cfisgroup.com

(614) 332-7464

PART # 0691-95

**ASSORTMENT: STEEL PIPE ADAPTERS**

01/22

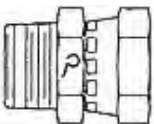
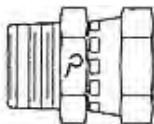
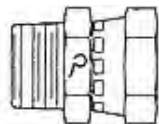
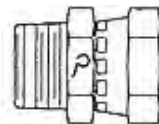
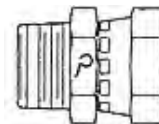
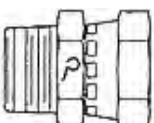
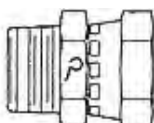
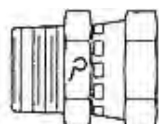
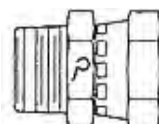
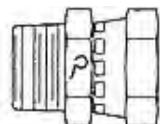

<p><b>A-1404-06-06</b> 1</p>  <p><b>3/8 P X 3/8 P SWIV</b></p>	<p><b>1404-08-06</b> 1</p>  <p><b>1/2 P X 3/8 P SWIV</b></p>	<p><b>A-1404-08-08</b> 1</p>  <p><b>1/2 P X 1/2 P SWIV</b></p>	<p><b>A-1404-08-12</b> 1</p>  <p><b>1/2 P X 3/4 P SWIV</b></p>	<p><b>A-1404-12-12</b> 1</p>  <p><b>3/4 P X 3/4 P SWIV</b></p>	
<p><b>A-1404--02-04</b> 1</p>  <p><b>1/8 P X 1/4 P SWIV</b></p>	<p><b>A-1404-04-02</b> 1</p>  <p><b>1/4 P X 1/8 P SWIV</b></p>	<p><b>A-1404-04-04</b> 1</p>  <p><b>1/4 P X 1/4 P SWIV</b></p>	<p><b>A-1404-04-06</b> 1</p>  <p><b>1/4 P X 3/8 P SWIV</b></p>	<p><b>A-1404-06-04</b> 1</p>  <p><b>3/8 P X 1/4 P SWIV</b></p>	







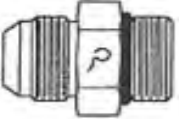
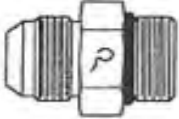
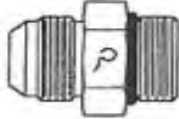
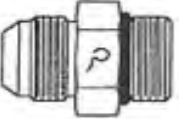
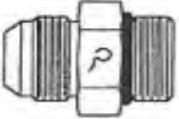
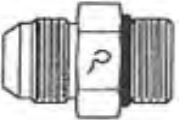
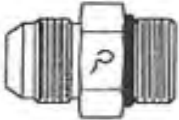
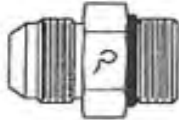
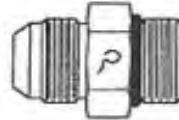
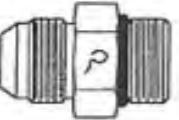
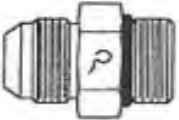
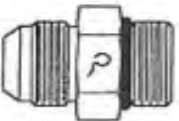
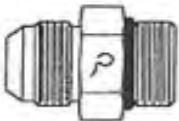
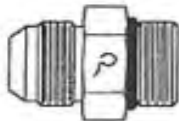
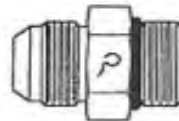
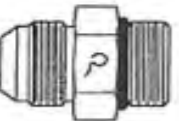
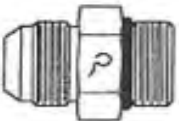
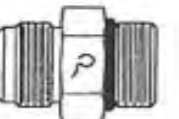
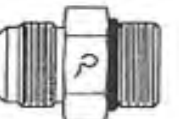
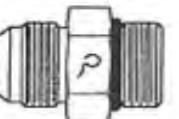

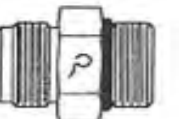
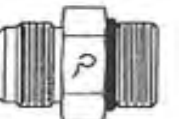





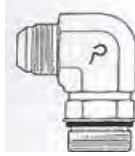

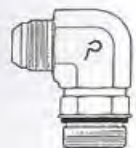







PART # 0691-120

# ASSORTMENT: STEEL JIC-O-RING ADAPTERS







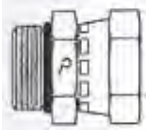
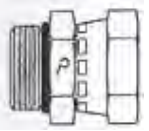
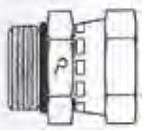
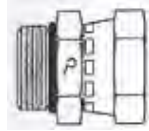
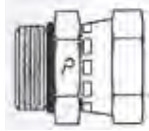
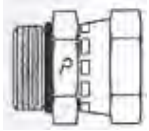
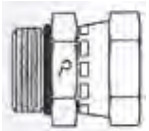

01/22

<p>A-6400-12-10 1</p>  <p>3/4T X 7/8-14</p>	<p>A-6400-12-12 1</p>  <p>3/4T X 1-1/16-12</p>	<p>A-6400-12-16 1</p>  <p>3/4T X 1-5/16-12</p>	<p>A-6400-14-14 1</p>  <p>7/8T X 1-3/16-12</p>		<p>A-6400-20-20 1</p>  <p>1" T X 1-5/8-12</p>
<p>A-6400-08-10 1</p>  <p>1/2T X 7/8-14</p>	<p>A-6400-08-12 1</p>  <p>1/2T X 1-1/16-12</p>	<p>A-6400-10-08 1</p>  <p>5/8T X 3/4-16</p>	<p>A-6400-10-10 1</p>  <p>5/8T X 7/8-14</p>	<p>A-6400-12-08 1</p>  <p>3/4T X 3/4-16</p>	<p>A-6400-16-20 1</p>  <p>1" T X 1-5/8-12</p>
<p>A-6400-06-06 1</p>  <p>3/8T X 9/16-18</p>	<p>A-6400-06-08 1</p>  <p>3/8T X 3/4-16</p>	<p>A-6400-06-10 1</p>  <p>3/8T X 7/8-14</p>	<p>A-6400-08-06 1</p>  <p>1/2T X 9/16-18</p>	<p>A-6400-08-08 1</p>  <p>1/2T X 3/4-16</p>	<p>A-6400-16-16 1</p>  <p>1" T X 1-5/16-12</p>
<p>A-6400-02-02 1</p>  <p>1/8T X 5/16-24</p>	<p>A-6400-04-04 1</p>  <p>1/4T X 7/16-20</p>	<p>A-6400-04-06 1</p>  <p>1/4T X 9/16-18</p>	<p>A-6400-05-05 1</p>  <p>5/16T X 1/2-20</p>	<p>A-6400-06-04 1</p>  <p>3/8T X 7/16-20</p>	<p>A-6400-16-12 1</p>  <p>1" T X 1-1/16-12</p>

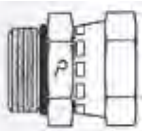
**PART # 0691-130 ASSORTMENT: STEEL O-RING BOSS ADAPTERS** 01/22

<p>A-6801-12-10-4 1</p>  <p>3/4T X 7/8-14</p>	<p>A-6801-12-12-4 1</p>  <p>3/4T X 1-1/16-12</p>	<p>A-6801-12-16-4 1</p>  <p>3/4T X 1-5/16-12</p>	<p>A-6801-14-14-4 1</p>  <p>7/8T X 1-3/16-12</p>		<p>A-6801-20-20-4 1</p>  <p>1" T X 1-5/8-12</p>
<p>A-6801-08-10-4 1</p>  <p>1/2T X 7/8-14</p>	<p>A-6801-08-12-4 1</p>  <p>1/2T X 1-1/16-12</p>	<p>A-6801-10-08-4 1</p>  <p>5/8T X 3/4-16</p>	<p>A-6801-10-10-4 1</p>  <p>5/8T X 7/8-14</p>	<p>A-6801-12-08-4 1</p>  <p>3/4T X 3/4-16</p>	<p>A-6801-16-20-4 1</p>  <p>1" T X 1-5/8-12</p>
<p>A-6801-06-06-4 1</p>  <p>3/8T X 9/16-18</p>	<p>A-6801-06-08-4 1</p>  <p>3/8T X 3/4-16</p>	<p>A-6801-06-10-4 1</p>  <p>3/8T X 7/8-14</p>	<p>A-6801-08-06-4 1</p>  <p>1/2T X 9/16-18</p>	<p>A-6801-08-08-4 1</p>  <p>1/2T X 3/4-16</p>	<p>A-6801-16-16-4 1</p>  <p>1" T X 1-5/16-12</p>
<p>A-6801-02-02-4 1</p>  <p>1/8T X 5/16-24</p>	<p>A-6801-04-04-4 1</p>  <p>1/4T X 7/16-20</p>	<p>A-6801-04-06-4 1</p>  <p>1/4T X 9/16-18</p>	<p>A-6801-05-05-4 1</p>  <p>5/16T X 1/2-20</p>	<p>A-6801-06-04-4 1</p>  <p>3/8T X 7/16-20</p>	<p>A-6801-16-12-4 1</p>  <p>1" T X 1-1/16-12</p>

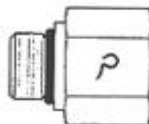
**PART # 0691-150 ASSORTMENT: STEEL O-RING BOSS ADAPTERS** 01/22

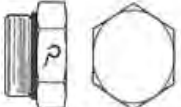
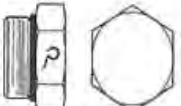
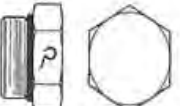
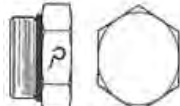
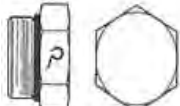
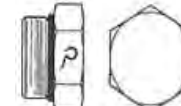
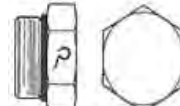









<p>A-6900-06-06 1</p>  <p>3/8P X 9/16-18</p>	<p>A-6900-06-08 1</p>  <p>1/2P X 9/16-18</p>	<p>A-6900-08-06 1</p>  <p>3/8P X 3/4-16</p>	<p>A-6900-08-08 1</p>  <p>1/2P X 3/4-16</p>	<p>A-6900-10-08 1</p>  <p>1/2P X 7/8-14</p>	<p>A-6900-12-08 1</p>  <p>1/2P X 1-1/16-12</p>
<p>A-6900-04-04 1</p>  <p>1/4P X 7/16-20</p>	<p>A-6900-04-06 1</p>  <p>3/8P X 1-7/16-20</p>	<p>A-6900-06-04 1</p>  <p>1/4P X 9/16-18</p>	<p>A-6405-10-08 1</p>  <p>1/2P X 7/8-14</p>	<p>A-6405-12-08 1</p>  <p>1/2P X 1-1/16-12</p>	
<p>A-6405-04-04 1</p>  <p>1/4PT X 7/16-20</p>	<p>A-6405-06-04 1</p>  <p>1/4TP X 9/16-18</p>	<p>A-6405-06-06 1</p>  <p>3/8P X 9/16-18</p>	<p>A-6405-08-06 1</p>  <p>3/8P X 3/4-16</p>	<p>A-6405-08-08 1</p>  <p>1/2P X 3/4-16</p>	<p>A-6408-12 1</p>  <p>7/8-14</p>
<p>A-6408-02 1</p>  <p>5/16-24</p>	<p>A-6408-04 1</p>  <p>3/8-24</p>	<p>A-6408-05 1</p>  <p>7/16-20</p>	<p>A06408-06 1</p>  <p>1/2-20</p>	<p>A-6408-08 1</p>  <p>9/16-18</p>	<p>A-6408-10 1</p>  <p>3/4-16</p>

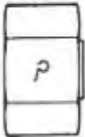

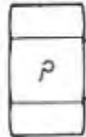
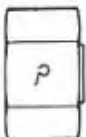
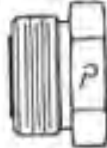

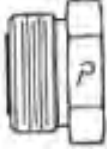

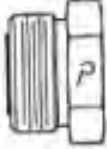
PART # 0691-160

**ASSORTMENT: STEEL FLAT SEAL ADAPTERS**

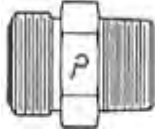
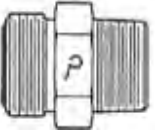
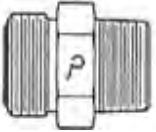
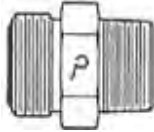
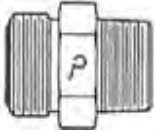
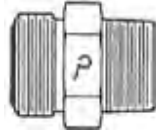
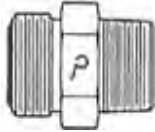
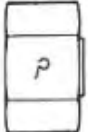
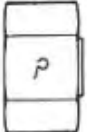
01/22

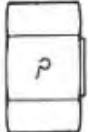
				<p>A-FS-304C-16 1</p>  <p>1-7/16-12</p>	<p>A-FS-304C-20 1</p>  <p>1-11/16-12</p>
<p>A-FS-304C-04 1</p>  <p>9/16-18</p>	<p>A-FS-304C-06 1</p>  <p>11/16-16</p>	<p>A-FS-304C-08 1</p>  <p>13/16-16</p>	<p>A-FS-304C-10 1</p>  <p>1-14</p>	<p>A-FS-304C-12 1</p>  <p>1-3/16-12</p>	<p>A-FS-304C-24 1</p>  <p>2-12</p>
				<p>A-FS-2408-16 1</p>  <p>1-7/16-12</p>	<p>A-FS-2408-20 1</p>  <p>1-11/16-12</p>
<p>A-FS-2408-04 1</p>  <p>9/16-18</p>	<p>A-FS-2408-06 1</p>  <p>11/16-16</p>	<p>A-FS-2408-08 1</p>  <p>13/16-16</p>	<p>A-FS-2408-10 1</p>  <p>1-14</p>	<p>A-FS-2408-12 1</p>  <p>1-3/16-12</p>	<p>A-FS-2408-24 1</p>  <p>2-12</p>

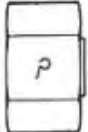
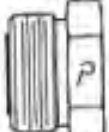
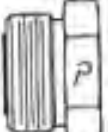
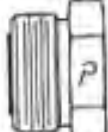
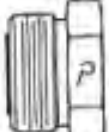
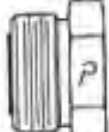
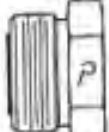
					<p><b>A-FS-2404-12-12</b></p> <p>1</p>  <p>1-3/16-12 X 3/4P</p>
<p><b>A-FS-2404-04-04</b></p> <p>1</p>  <p>9/16-18 X 1/4P</p>	<p><b>A-FS-2404-06-04</b></p> <p>1</p>  <p>11/16-16 X 1/4P</p>	<p><b>A-FS-2404-06-06</b></p> <p>1</p>  <p>11/16-16 X 3/8P</p>	<p><b>A-FS-2404-08-06</b></p> <p>1</p>  <p>13/16-16 X 3/8P</p>	<p><b>A-FS-2404-08-08</b></p> <p>1</p>  <p>13/16-12 X 1/2P</p>	<p><b>A-FS-2404-10-12</b></p> <p>1</p>  <p>1-14 X 3/4P</p>
<p><b>A-FS-304C-04</b></p> <p>1</p>  <p>9/16-18</p>	<p><b>A-FS-304C-06</b></p> <p>1</p>  <p>11/16-16</p>	<p><b>A-FS-304C-08</b></p> <p>1</p>  <p>13/16-16</p>	<p><b>A-FS-304C-10</b></p> <p>1</p>  <p>1-14</p>	<p><b>A-FS-304C-12</b></p> <p>1</p>  <p>1-3/16-12</p>	<p><b>A-FS-304C-16</b></p> <p>1</p>  <p>1-7/16-12</p>
<p><b>A-FS-2408-04</b></p> <p>1</p>  <p>9/16-18</p>	<p><b>A-FS-2408-06</b></p> <p>1</p>  <p>11/16-16</p>	<p><b>A-FS-2408-08</b></p> <p>1</p>  <p>13/16-16</p>	<p><b>A-FS-2408-10</b></p> <p>1</p>  <p>1-14</p>	<p><b>A-FS-2408-12</b></p> <p>1</p>  <p>1-3/16-12</p>	<p><b>A-FS-2408-16</b></p> <p>1</p>  <p>1-7/16-12</p>



**CANTON FLEET - INDUSTRIAL SUPPLY**  
**COLUMBUS FLEET - INDUSTRIAL SUPPLY**

WWW.cfisgroup.com

(614) 332-7464

PART # 0691-185

**ASSORTMENT: HYD FLAT SEAL /O-RING BOSS**

01/22

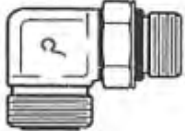
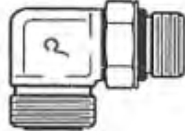
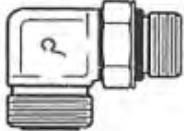
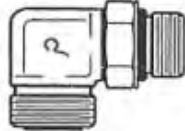
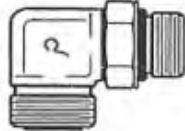
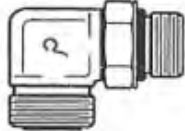
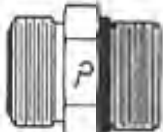
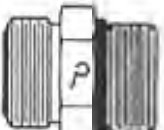
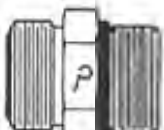
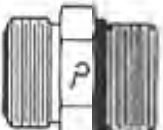
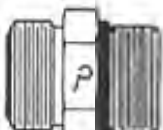
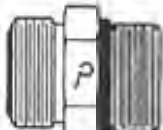
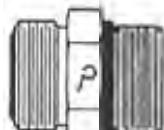

























<p>A-FS- 6801-04-04</p>  <p>1</p> <p>9/16-18 X 7/16-20</p>	<p>A-FS-6801-06-06</p>  <p>1</p> <p>11/16-16 X 9/16-18</p>	<p>A-FS-6801-08-08</p>  <p>1</p> <p>13/16-16 X 3/4-16</p>	<p>A-FS-6801-10-10</p>  <p>1</p> <p>1-14 X 7/8-14</p>	<p>A-FS-6801-12-10</p>  <p>1</p> <p>1-3/16-12 X 7/8-14</p>	<p>A-FS-6801-12-12</p>  <p>1</p> <p>1-3/16-12 X 1-1/16-12</p>
				<p>A-FS-6400-08-10</p>  <p>1</p> <p>13/16-16 X 7/8-14</p>	
<p>A-FS-6400-04-04</p>  <p>1</p> <p>9/16-18 X 7/16-20</p>	<p>A-FS-6400-04-05</p>  <p>1</p> <p>9/16-18 X 5/16-20</p>	<p>A-FS-6400-06-06</p>  <p>1</p> <p>11/16-16 X 9/16-18</p>	<p>A-FS-6400-08-08</p>  <p>1</p> <p>13/16-16 X 3/4-16</p>	<p>A-FS-6400-10-10</p>  <p>1</p> <p>1-14 X 7/8-14</p>	<p>A-FS-6400-12-12</p>  <p>1</p> <p>1-3/16-12 X 1-1/16-12</p>



**PART # 0691-90**

**ASSORTMENT: HYDRAULIC O-RING**

01/22

<p><b>A-3-920</b> 5</p>  <p>1-5/8-12</p> <p><b>ORING BOSS</b></p>	<p><b>A-3-924</b> 5</p>  <p>1-7/8-12</p> <p><b>ORING BOSS</b></p>	<p><b>A-3-932</b> 5</p>  <p>2-1/2-12</p> <p><b>ORING BOSS</b></p>					
<p><b>A-3-904</b> 10</p>  <p>7/16-20</p> <p><b>ORING BOSS</b></p>	<p><b>A-3-905</b> 10</p>  <p>1/2-20</p> <p><b>ORING BOSS</b></p>	<p><b>A-3-906</b> 10</p>  <p>9/16-18</p> <p><b>ORING BOSS</b></p>	<p><b>A-3-908</b> 10</p>  <p>3/4-16</p> <p><b>ORING BOSS</b></p>	<p><b>A-3-910</b> 10</p>  <p>7/8-18</p> <p><b>ORING BOSS</b></p>	<p><b>A-3-912</b> 10</p>  <p>1-1/16-12</p> <p><b>ORING BOSS</b></p>	<p><b>A-3-914</b> 10</p>  <p>1-3/16-12</p> <p><b>ORING BOSS</b></p>	<p><b>A-3-916</b> 10</p>  <p>1-5/16-12</p> <p><b>ORING BOSS</b></p>
<p><b>A-FS-904</b> 10</p>  <p>1/4</p> <p><b>FACE SEAL</b></p>	<p><b>A-FS-906</b> 10</p>  <p>3/8</p> <p><b>FACE SEAL</b></p>	<p><b>A-FS-908</b> 10</p>  <p>1/2</p> <p><b>FACE SEAL</b></p>	<p><b>A-FS-910</b> 10</p>  <p>5/8</p> <p><b>FACE SEAL</b></p>	<p><b>A-FS-912</b> 10</p>  <p>3/4</p> <p><b>FACE SEAL</b></p>	<p><b>A-FS-916</b> 10</p>  <p>1"</p> <p><b>FACE SEAL</b></p>	<p><b>A-FS-920</b> 5</p>  <p>1-1/4</p> <p><b>FACE SEAL</b></p>	<p><b>A-FS-924</b> 5</p>  <p>1-1/2</p> <p><b>FACE SEAL</b></p>
<p><b>A-610-08</b> 10</p>  <p>1/2</p> <p><b>CODE 61,62</b></p>	<p><b>A-610-10</b> 10</p>  <p>5/8</p> <p><b>CODE 61,62</b></p>	<p><b>A-610-12</b> 10</p>  <p>3/4</p> <p><b>CODE 61,62</b></p>	<p><b>A-610-16</b> 10</p>  <p>1"</p> <p><b>CODE 61,62</b></p>	<p><b>A-610-20</b> 10</p>  <p>1-1/4</p> <p><b>CODE 61,62</b></p>	<p><b>A-610-24</b> 10</p>  <p>1-1/2</p> <p><b>CODE 61,62</b></p>	<p><b>A-610-32</b> 10</p>  <p>2"</p> <p><b>CODE 61,62</b></p>	



**CANTON FLEET - INDUSTRIAL SUPPLY**  
**COLUMBUS FLEET - INDUSTRIAL SUPPLY**































WWW.cfisgroup.com

(614) 332-7464

PART # 0725-25

**ASSORTMENT: CAP PLUGS**

























01/22

<p>690-208 5</p>  <p>#16</p>	<p>690-212 5</p>  <p>#17</p>	<p>690-216 5</p>  <p>#17-S</p>	<p>690-220 5</p>  <p>#18</p>	<p>690-224 4</p>  <p>#19</p>	<p>690-228 3</p>  <p>#20</p>	<p>690-232 3</p>  <p>#20-S</p>	
<p>690-176 10</p>  <p>#11</p>	<p>690-180 10</p>  <p>#11-X</p>	<p>690-184 10</p>  <p>#12-X</p>	<p>690-188 10</p>  <p>#13</p>	<p>690-192 10</p>  <p>#13-X</p>	<p>690-196 5</p>  <p>#14</p>	<p>690-200 5</p>  <p>#14-X</p>	<p>690-204 5</p>  <p>#15-X</p>
<p>690-144 10</p>  <p>#6</p>	<p>690-148 10</p>  <p>#6-X</p>	<p>690-152 10</p>  <p>#7</p>	<p>690-156 10</p>  <p>#8</p>	<p>690-160 10</p>  <p>#8-X</p>	<p>690-164 10</p>  <p>#9</p>	<p>690-168 10</p>  <p>#9-X</p>	<p>690-172 10</p>  <p>#10</p>
<p>690-112 10</p>  <p>#1</p>	<p>690-116 10</p>  <p>#2</p>	<p>690-120 10</p>  <p>#2-X</p>	<p>690-124 10</p>  <p>#3</p>	<p>690-128 10</p>  <p>#3-X</p>	<p>690-132 10</p>  <p>#4</p>	<p>690-136 10</p>  <p>#4-X</p>	<p>690-140 10</p>  <p>#5</p>

**PART # 0725-35**

**ASSORTMENT: CAP PLUGS**

01/22

<p>690-112 10</p>  <p>#1</p>	<p>690-116 10</p>  <p>#2</p>	<p>690-120 10</p>  <p>#2-X</p>	<p>690-124 10</p>  <p>#3</p>	<p>690-128 10</p>  <p>#3X</p>	<p>690-200 5</p>  <p>#14X</p>
<p>690-132 10</p>  <p>#4</p>	<p>690-136 10</p>  <p>#4-X</p>	<p>690-140 10</p>  <p>#5</p>	<p>690-144 10</p>  <p>#6</p>	<p>690-148 10</p>  <p>#6-X</p>	<p>690-204 5</p>  <p>#15-X</p>
<p>690-156 10</p>  <p>#8</p>	<p>690-160 10</p>  <p>#8-X</p>	<p>690-164 10</p>  <p>#9</p>	<p>690-168 10</p>  <p>#9-X</p>	<p>690-172 10</p>  <p>#10</p>	<p>690-216 5</p>  <p>#17-S</p>
<p>690-176 5</p>  <p>#11</p>	<p>690-180 5</p>  <p>#11-X</p>	<p>690-184 5</p>  <p>#12-X</p>	<p>690-192 5</p>  <p>#13-X</p>	<p>690-196 5</p>  <p>#14</p>	<p>690-220 5</p>  <p>#18-X</p>



# 24 HOLE BOLT ASSORTMENT PLANOGRAPH



# 32 HOLE BOLT ASSORTMENT PLANOGRAPH



# 40 HOLE BOLT ASSORTMENT PLANOGRAPH



# ADJ HOLE BOLT ASSORTMENT PLANOGRAPH



# 20 HOLE BOLT ASSORTMENT PLANOGRAPH



# 21 HOLE BOLT ASSORTMENT PLANOGRAPH



# 12 HOLE BOLT ASSORTMENT PLANOGRAPH
